

Compendium of Sanitation Systems and Technologies for the Wider Caribbean Region

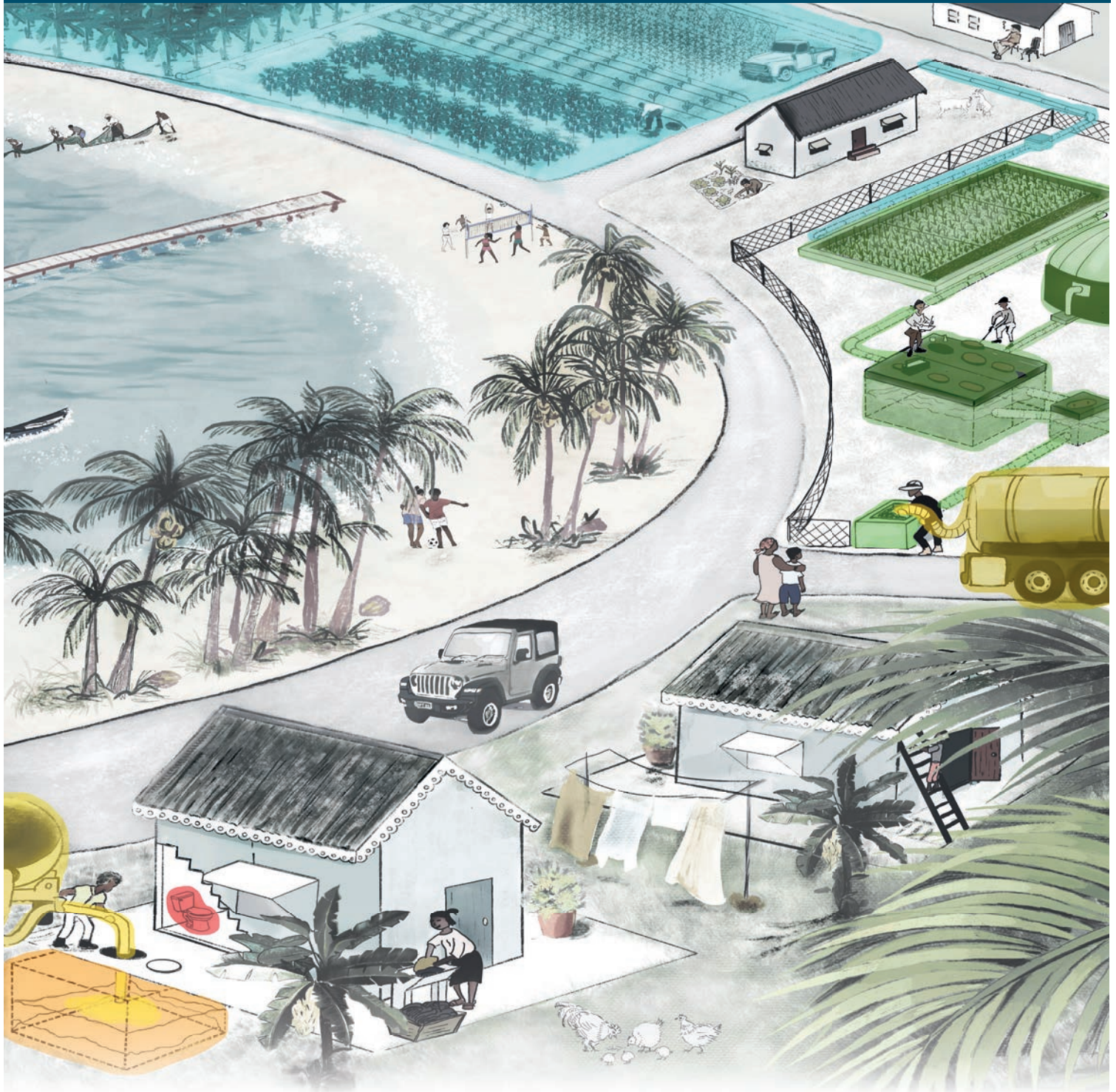



The GEF CReW+ is a partnership project funded by the Global Environment Facility (GEF) that is being co-implemented by the Inter-American Development Bank (IDB) and the United Nations Environment Programme (UNEP) in 18 countries of the Wider Caribbean Region (WCR).

This project builds upon its previous successful phase “The Caribbean Regional Fund for Wastewater Management (CReW)” project (2011-2017). CReW+ is being executed by the Deutsche Gesellschaft für Internationale Zusammenarbeit (GIZ) GmbH, the Organisation of the American States (OAS) and the Secretariat of the Cartagena Convention (CAR/RCU) on behalf of the IDB and UNEP respectively.

The 18 participating CReW+ countries (Barbados, Belize, Colombia, Costa Rica, Cuba, Dominican Republic, Grenada, Guatemala, Guyana, Honduras, Jamaica, Mexico, Panama, Saint Kitts and Nevis, Saint Lucia, St. Vincent and the Grenadines, Suriname and Trinidad and Tobago) vary geographically from large, continental countries to small island states, with significantly different political, linguistic and cultural contexts.

About the GEF: The Global Environment Facility (GEF) has provided \$22 million in grants and blended finance and mobilised nearly \$120 billion in co-financing for more than 5 200 projects and programmes. The GEF is the largest trust fund focused on enabling developing countries to invest in nature and supports the implementation of international conventions on biodiversity, climate change, chemicals and desertification. It brings together 184 governments, plus civil society, international organisations, the private sector and partners.

Financed by:



Implemented by:



Co-executed by:



OAS | More rights for more people

Compendium of Sanitation Systems and Technologies for the Wider Caribbean Region

A Guide for Implementing the RSAP in the Sanitation Sector

The Regional Strategic Action Plan for the Water Sector in the Caribbean (RSAP) was developed by Regional Stakeholders in 2018 and endorsed in 2019 by the Declaration of Basseterre.

**Stefan Reuter, Dierk Demant, Gustavo Heredia, Christoph Lüthi,
Philippe Reymond, Roland Schertenleib, Lukas Ulrich and Christian Zurbrügg**

Our special thanks go to:
the Sustainable Sanitation Alliance (SuSanA), Regional Chapter Latin America
the Sanitation for Millions global programme
the International Water Association (IWA) specialist groups
and the participants of the GEF CREW+ Project

This compendium is based on the work of Elizabeth Tilley,
lead author of the Editions 2008 and 2014 of the Eawag Compendium
of Sanitation Systems and Technologies

We would like to thank the following individuals
for their contributions and comments:
Jessica Altenburger, Raluca Anisie, Victor Cantarero, Gustavo Cubero, Cécile Dekeuwer,
Eduardo Falcon, Diana Garcia Moreno, Robert Gensch, Helmut Gerber, Sara-Jade Govia,
Jorge Jaén, Ignatius Jean, Günther Klatte, Pedro Kraemer, Tizian Kuempel, Günter Langergraber,
Hans Jörg Lerchenmüller, Ricardo Martinez Lagunes, Jennifer McConville, Mona Mijthab,
Carine Mineau, Abishek S. Narayan, Diana Ramírez, Samuel Renggli, Dorothee Spuhler,
Konstantina Velkushanova, Uver Villalobos Cardozo, David Wilk, Leif Wolf

We would like to acknowledge the support from:
the Deutsche Gesellschaft für Internationale Zusammenarbeit (GIZ) GmbH granting this work on behalf of
the Inter-American Development Bank and the BMZ
in the framework of the CREW+ project funded by the Global Environment Facility.

- CWWA Caribbean Water and Wastewater Association, Trinidad and Tobago,
<https://cwwa.net>
- CAWASA Caribbean Water and Sewerage Association, Saint Lucia,
www.cawasa.org
- EAWAG Swiss Federal Institute of Aquatic Science and Technology,
Sandec - Department Sanitation, Water and Solid Waste for Development, Switzerland,
www.sandec.ch/compendium
- BORDA Bremen Overseas Research and Development Association, BORDA Las Américas, Mexico,
www.borda-la.org



Sara-Jade Govia
CWWA



Ignatius Jean
CAWASA



Christoph Lüthi
EAWAG



Pedro Kraemer
BORDA

Sanitation is a key element of sustainable development and significantly influences people’s health and wellbeing. This became especially apparent during the COVID pandemic. This Compendium builds on the considerable efforts made by previous authors and partnerships to promote improved sanitation by providing an easily accessible knowledge base and guidance about how to achieve these improvements.

Climate change has a profound impact on how communities around the world can reliably access clean water and sanitation. Climate change can also cause poor water quality and scarcity and puts significant stress on infrastructure through too much rainfall, drought, rising sea levels and damaging runoff. For the Wider Caribbean Region (WCR), the challenge is compounded by climate change’s impact on weather patterns, bringing more and stronger storms and extreme dry events. Weather events that historically have been considered one-hundred-year events are happening more and more frequently. That is why sustainable management of water and sanitation is so important. We must be able to meet the needs of the present without compromising the ability of future generations to do the same. Our shared framework for this is the “Regional Strategic Action Plan for the Water Sector in the Caribbean to Develop Resilience to the Impacts of Climate Change” (RSAP). Developed by Regional Stakeholders around the 2018 World Water Forum, it was endorsed in 2019 during the 15th High-Level Forum for Caribbean Ministers Responsible for Water with the “Declaration of Basseterre” and subsequent annual implementation plans co-ordinated by CWWA.

The first two Compendia produced by Eawag and partners in 2008 and 2014 provided knowledge on a wide range of sanitation technologies without bias and/or agenda. They helped to increase the recognition that a fully functioning sanitation ‘chain’ must link toilets to a treatment facility via an operational collection and conveyance system. They also presented resource recovery and reuse options as necessary objectives for the sustainable management of excreta. In recent years, the Compendium has become the most popular technical compilation in the sanitation sector and is widely acclaimed by a large audience as an international reference tool.

Tailored to the specific needs of utilities in the WCR, this Compendium is complemented with two new sections: Part 3 addresses planning and decision-making issues relevant to the implementation of the RSAP in the sanitation sector. Part 4 integrates all elements from Parts 1, 2 and 3 into selected case studies. Various systems and technologies are explained including their system template, institutional, regulatory and financial aspects, as well as lessons learned. Therefore, this Compendium is rightly subtitled: *“A Guide for Implementing the RSAP in the Sanitation Sector”*.

We believe that our on-going collective efforts in the region will help to ensure the achievement of the Sustainable Development Goal on sanitation (SDG6). Doing so, we will substantially contribute to achieving water security and enabling other SDGs, e.g. health and well-being, life on land and below water, as well as climate action. *We hope you enjoy reading this Compendium and look forward to hearing from you.*

Table of Contents

Introduction	7
Background and Target Audience	7
What's New in the WCR Edition?	7
Current Sanitation Status in the WCR	7
New Paradigm for Provision of Water & Sanitation Services	8
Structure and Use of the Compendium	9
Complementary Compendia and Sanitation Sector Development Tools	10
Compendium Terminology	12
Sanitation Systems	12
Products	12
Functional Groups	14
Sanitation Technologies	15
Part 1: System Templates	17
<hr/>	
Using the System Templates	18
System 1: Blackwater System with On-site Effluent Infiltration and Off-site Sludge Treatment	22
System 2: Blackwater System with On-site Sludge Production and Off-site Effluent/Sludge Treatment	24
System 3: Holding Tank System with Motorised Transport to Off-site Treatment	26
System 4: Sewered System without On-site Storage	28
System 5: Sewered System with Urine Diversion and Transport to Off-site Application of Urine	30
System 6: Container-based System with Urine Diversion and Transport to Off-site Treatment	32
Part 2: Functional Groups with Technology Information Sheets	35
<hr/>	
Reading the Technology Information Sheets	36
U User Interface	38
U.1 Cistern Flush Toilet	40
U.2 Urinal	42
U.3 Urine-Diverting Flush Toilet (UDFT)	44
U.4 Urine-Diverting Dry Toilet (UDDT)	46

S Collection and Storage/Treatment	48
S.1 Storage Tank/Container	50
S.2 Holding Tank	52
S.3 Septic Tank	54
S.4 Anaerobic Baffled Reactor (ABR)	56
S.5 Anaerobic Filter	58
S.6 Submerged Aerated Fixed-Film Reactor (SAFF)	60
C Conveyance	62
C.1 Human-Powered Transport	64
C.2 Motorised Emptying and Transport	66
C.3 Simplified Sewer	68
C.4 Solids-Free Sewer	70
C.5 Conventional Sewer	72
T (Semi-) Centralised Treatment	74
PRE Pre-Treatment Technologies	76
T.1 Settler	78
T.2 Imhoff Tank	80
T.3 Anaerobic Baffled Reactor (ABR)	82
T.4 Anaerobic Filter	84
T.5 Waste Stabilisation Ponds (WSP)	86
T.6 Aerated Pond	88
T.7 Free-Water Surface Wetland (FWSW)	90
T.8 Horizontal Flow Wetland (HFW)	92
T.9 Vertical Flow Wetland (VFW)	94
T.10 Floating Treatment Wetland (FTW)	96
T.11 Trickling Filter	98
T.12 Upflow Anaerobic Sludge Blanket Reactor (UASB)	100
T.13 Activated Sludge	102
T.14 Sedimentation/Thickening Ponds	104
T.15 Unplanted Drying Beds	106
T.16 Planted Drying Beds	108
T.17 Co-Composting	110
T.18 Biogas Reactor	112
T.19 Carbonisation	114
POST Tertiary Filtration and Disinfection	116
R Reuse and/or Disposal	118
R.1 Application of Stored Urine	120
R.2 Application of Compost	122
R.3 Application of Sludge	124
R.4 Application of Effluent/Irrigation	126
R.5 Soak Pit	130

R.6 Leach Field	132
R.7 Fish Pond	134
R.8 Floating Plant Pond	136
R.9 Water Disposal/Groundwater Recharge	138
R.10 Surface Disposal and Storage	140
R.11 Biogas Combustion	142
R.12 Application of Biochar	144
Emerging Sanitation Technologies	147

Part 3: Cross-Cutting Issues for Planning and Decision-Making 156

X A - Stakeholder Engagement	158
X B - Gender Sensitivity	160
X C - Climate Resilience	162
X 1 - Climate-Resilient Water Governance	170
X 2 - Climate-Resilient Water Resources Management	177
X 3 - Climate-Informed Decision Support	182
X 4 - Climate-Resilient Water and Sanitation Service Provision	184
X 5 - Capacity Building and Sensitisation for Climate Resilience	196

Part 4: Case Studies 200

Case 1: Nature-Based Wastewater Treatment for New Housing Developments in Penonome, Panama	202
Case 2: Integrated Management of Wastewater and Biosolids in a Slaughter House in Leon, Nicaragua	206
Case 3: Semi-Centralised Wastewater Treatment for New Housing Developments in Nindiri, Nicaragua	212
Case 4: Wastewater Treatment and Reuse for Golf Course Irrigation in a Large Beach Resort in Punta Cana, Dominican Republic	216
Case 5: Water Savings and Sustainable Sanitation with Container-Based Sanitation for a Periurban Community at Lake Atitlan, Guatemala	220
Case 6: Wastewater Treatment and Reuse for Crop Irrigation at Municipal Level in Tolata, Bolivia	226

Glossary	232
-----------------	------------

References & Further Reading	238
---	------------

Imprint	266
----------------	------------

Introduction

Background and Target Audience This is the first Compendium for the WCR. It has been adapted to the needs of the region through prior research, active stakeholder involvement and contextualisation of the technical and social aspects that will allow for the application of the technologies presented. This Compendium is largely based on the Eawag Compendium of Sanitation Systems and Technologies, first published in 2008, with a second updated edition published in 2014.

Since then, the Eawag Compendium has been translated into several languages and distributed digitally by various sector organisations. The document's popularity lies in its brevity – structuring and presenting a huge range of information on tried and tested technologies in a single document. As in these previous editions, we:

- do not consider sanitation technologies that are under development or that exist only as prototypes,
- only include “improved” sanitation technologies that provide safe, hygienic and accessible sanitation,
- include gravity-fed technologies operating without energy supply, being resilient to power outages and not increasing CO₂ emissions, many of which are nature-based solutions,
- present circular economy systems that safely recover and recycle water, energy, nutrients and biosolids for value-adding activities, such as irrigation, energy or compost production.

The focus of this Compendium is on the range of urban and periurban technologies that can be provided and managed as a utility service. Accordingly, we refrain from highlighting various pit latrine technologies as information about them are widely available in the English, French and Spanish Compendia, including the more interactive online version entitled “*Sanitation Systems Perspective*” (p. 11). This Compendium is the first to feature Container Based Sanitation, which has been successfully implemented and operated in the region (<https://cbsa.global>) and, compared to pit latrines, is the preferred option from an economic and health perspective (Sklar and Faustin, 2017).

The Compendium is a guidance document for engineers and planners in the Wider Caribbean Region and beyond and is primarily intended to be used for communicative planning processes involving local communities. It is also intended for persons/experts who have detailed knowledge about conventional high-end technologies (such as infrastructure implementers, contractors and consultants), requiring information on alternative/different system configurations. It is not intended as a stand-alone document for engineers, making decisions for the community, i.e. expert-driven decision-making. Various means of dissemination, such as www.susana.org and a MOOC on <https://academy.gefcrew.org> will accompany its publication.

What's New in this Edition for the Wider Caribbean Region (WCR)?

1. Six sanitation systems (instead of nine) and a total of 48 technology sheets (instead of 57) tailored to the specific needs of the WCR from a utility perspective.
2. Revised technology descriptions with updated references and improved illustrations based on reviews by renowned sector experts and taking into account key developments in the sector over the last eight years.
3. Biochar as a new output product.
4. Four new technology information sheets and an updated section on emerging technologies.
5. An additional sanitation system, “System 3: Holding Tank System”.
6. An additional Part 3 addressing issues relevant for decision-making, relating to the natural, the built and the enabling environment.
7. A new Part 4 with six selected case studies, showcasing systems and technologies under real life conditions including institutional, regulatory and financial aspects, as well as lessons learned.

Current Sanitation Status in the WCR

The process of contextualising a well known and much utilised publication – as the Compendium undoubtedly is – to a regional context brings its own trade-offs. While there is arguably the need for a concise overview, poten-

tially answering questions, such as: “What is the baseline scenario; Where do we start from?”, there are also good reasons to be very careful with terms like “status”, as these tend to be periodically updated - sometimes annually - and, therefore, could quickly make this Compendium outdated.

Here are five key takeaways that offer a first orientation about the present sanitation situation/status. For further information, there is a publication list at the end.

- 1. Numbers** The coverage of conventional sewerage connected to wastewater treatment plants in the Wider Caribbean Region ranges from 0 - 30 %. Sanitation is predominantly provided by septic tanks and other onsite solutions. Pit latrines continue to exist - in areas served by utilities predominantly in informal settlements. Where they cannot be safely managed and pose a threat to public and environmental health, better solutions are required.
- 2. Priorities** Utilities in the region struggle with addressing Non Revenue Water, ranging from 20 to 70 % in the region. In this context, sanitation coverage seems to be less of a priority - an impression that is misleading, as unsafe sanitation services will only aggravate the reluctance and unwillingness to pay for water. From the perspective of a government authority or international donor, doubts may arise, as to how a utility - unable to run a financially healthy water supply - should take on and reliably manage the complex task of providing and safely managing sanitation for all citizens in their service area.
- 3. Catch-22** A utility may be in the dilemma of facing “unsolvable” expectations: to invest in better services in terms of quality and quantity, while having to cope with a tariff not even covering operational cost (and transfers and taxes, the other two sources of revenue for better services being out of reach).
- 4. Externalities** Policy makers, administrators, operators and users alike are impacted by changing factors typically perceived as “external”, i.e. seemingly beyond the sphere of influence: the rise of sea water level/increasing salinity, unpredictable patterns of rainfall and drought, impact of tropical storms and other natural disaster increasing in frequency and severity.
- 5. Opportunity** A high potential for energy self-sufficiency and without the legacy of bulky and expensive sewage infrastructure make a good starting point for innovation and transformational change towards more circularity and nature-based solutions.

New Paradigm for Provision of Water & Sanitation Services

The climate is changing. According to the concept of “Planetary Boundaries”, five boundaries of nine “planetary life support systems” have been transgressed: climate, biodiversity, land use, biogeochemical flows (namely phosphorus and nitrogen cycles, see Figure 1) and novel entities. The nations of the world, under the umbrella of the UN, have agreed to act, as documented in the Paris Climate Agreement from 2015. In fact, this consensus means nothing less than replacing our old paradigm of linearity with the new paradigm of circularity, for production and consumption alike:

- replace the exploration, production and burning of fossil fuels by renewable energy production,
- replace freshwater consumption and discharge of ‘waste’-water (polluting receiving waters with organic compounds and nutrients) with circular thinking for water and carbon/energy, as well as circular consumption and production patterns, e.g. through beneficial reuse of nutrients in horti- and agriculture (see functional group R and X 1.2.1 on p. 174).

The time of linearity is over. It is in our hands, not whether, but how fast we adapt and make use of the new normal! Water and especially sanitation services are at the core of this.

The key connector and enabler for how we do things across sectors based on the new paradigm is water. It

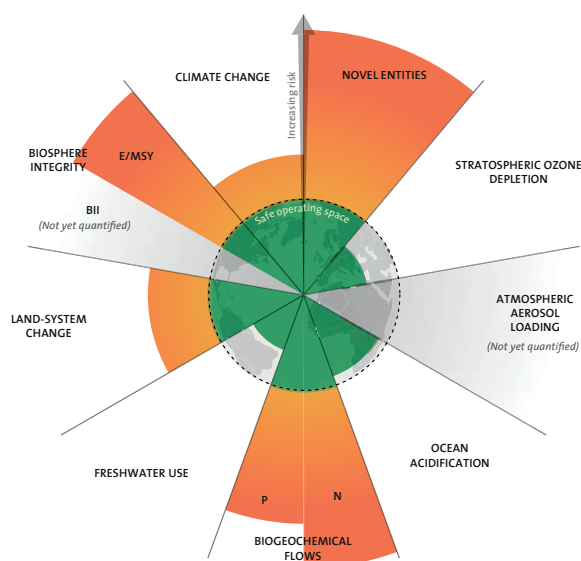

Figure 1: Five of the nine planetary boundaries transgressed, Illustration by Azote for Stockholm Resilience Centre, based on Analysis in Person et al., 2022 and Steffen et al., 2015.

is essential not only for basic needs and ecosystems, but for producing food and energy and to support livelihoods and industry. It also plays a role in the spiritual and aesthetic lives of billions of people. Water management is, therefore, not only an end in itself, but needs to be handled sustainably.

This new paradigm is deeply embedded in the structure of this Compendium, e.g. by:

- visualising the flow of all resources until their safely managed recovery and reuse,
- fostering recovery and reuse from wastewater,
- using technologies that do not consume energy and others that produce energy,
- highlighting technologies that keep nutrients out of the ocean and on land, in the food cycle, and
- covering technologies that bind CO₂ extracted by plants from the atmosphere through carbonisation and that store it in the form of biochar long term, e.g. in the soil (negative emission technology).

Structure and Use of the Compendium

The first two parts of this Compendium are in line with the previous one: **Part 1** the **System Templates** and a description about how to use them and **Part 2** the **Technology Information Sheets**.

It is recommended that the Compendium user first review the sections “Compendium Terminology” (pp. 12-15) and “Using the System Templates” (pp. 18-21), to become familiar with the key terms and structure of the system templates and their components. Thereafter, the user can move between the system templates and technology information sheets (they are cross-referenced) until he/she has identified systems and/or technologies appropriate for further investigation. Eventually, the user should be able to develop one or several system configurations to present to the community of the intervention area. Following the community’s suggestions, the Compendium can then be used to re-evaluate and redesign the systems accordingly.

The Compendium is only one document in the field to facilitate informed decision-making on the part of different stakeholders involved in improving environmental sanitation services and should be used in conjunction with other available publications and tools. An overview of complementary sanitation sector development tools is provided on the following double page.

The selection of an appropriate sanitation system combining the most relevant sanitation technologies does not obey technical considerations only. It is influenced by surrounding factors, such as:

- the local built and natural environment above and underground,
- mega-trends such as climate change and
- the so-called “enabling environment”, including
 - political leadership,
 - empowered communities,
 - effective regulation and accountability.

In taking these factors into account lies the key for successful (or unsuccessful) contextualisation and transfer of solutions proven elsewhere. They are addressed in a new **Part 3** as cross-cutting issues essential for planning and decision making.

It is important to note that regional stakeholders including authorities, utilities, professional associations and political leadership from the Wider Caribbean Region are fully aware of the factors mentioned above. In response, they have demonstrated collective leadership and strategic vision by developing and adopting a shared framework for action: the “Regional Strategic Action Plan for the Water Sector in the Caribbean to Develop Resilience to the Impacts of Climate Change” (RSAP). Annual implementation plans ensure that the RSAP is monitored and updated. The 2nd Implementation Plan (2021) sums it in a nutshell: “To succeed, the RSAP will require stakeholders at all levels to deviate from business as usual.”

Part 3 adopts the strategic elements of the RSAP (Foundation, Objective and Supporting Pillars) chapter by chapter, assigning appropriate planning elements and information to each.

Another “first” is the endeavour to respond to stakeholders’ demands during the preparation of this Compendium by adding relevant Case Studies that complement the soberly well-structured logic of the Compendium with a dose of “see, feel, & touch”. The result can be inspected in **Part 4**.

References & Further Reading

can be found on page 238

Complementary Compendia and Sanitation Sector Development Tools

In the past few years, a number of documents have been published that complement this work and add to the growing body of sustainable technology reference materials and practical guides. Some are presented below:



Compendium of Sanitation Systems and Technologies

A planning tool for making more informed choices

This second, revised edition of the Compendium presents a huge range of information on sanitation systems and technologies in one volume. Tried and tested technologies are ordered and structured into one concise document.

Part 1 describes different system configurations for a variety of contexts; Part 2 consists of 57 different technology information sheets, which describe the main advantages, disadvantages, applications and the appropriateness of the technologies required to build a comprehensive sanitation system. Each technology information sheet is complemented by a descriptive illustration. Available also in Spanish and French

By Tilley, E., Ulrich, L., Lüthi, C., Reymond, P., Schertenleib, R. and Zurbrügg, C. (2014). Eawag (Sandec), IWA, WSSCC. Free PDF available at: www.sandec.ch/compendium



Compendium of Sanitation Technologies in Emergencies

Informed decision making for developing a sanitation system design

This Compendium extends the scope of Sandec's initial Compendium (above) to the field of humanitarian aid. Not only does it cover a wider array of technologies, applicable to the different phases of an emergency, but it also provides an overview of the key cross-cutting issues influencing technology selection and supporting implementation in these contexts. It is a comprehensive, structured and user-friendly manual. It compiles a wide range of information on tried and tested technologies in a single document and gives a systematic overview of existing and emerging sanitation technologies. In addition, it gives concise information on key decision criteria for each technology, facilitating the combination of technologies to come up with full sanitation system solutions, all linked to relevant cross-cutting issues. Available also in French: www.emersan-compendium.org/fr/ By Gensch, R., Jennings, A., Renggli, S., Reymond, P. (2018). German WASH Network and Eawag (Sandec). Free PDF available at: www.emersan-compendium.org/en/



Guide to Sanitation Resource Recovery Products & Technologies

A supplement to the Compendium of Sanitation Systems and Technologies

This manual provides an overview of the possibilities for resource recovery from sanitation and provides guidance on treatment processes to achieve safe products for reuse. The focus of this document is on resource recovery from the organic wastes managed in sanitation systems and, to a lesser extent, on the recovery of water and energy generation. Resource recovery sanitation systems are defined as systems that safely recycle excreta and organic waste while minimising the use of non-renewable resources such as water and chemicals. Safe recycling means that waste flows are managed so that physical, microbial and chemical risks are minimised.

By McConville, J., Niwagaba, C., Nordin, A., Ahlström, M., Namboozo, V. and Kiffe, M. (2020). Swedish University of Agricultural Sciences (SLU), Department of Energy and Technology. Free PDF available at: <https://pub.epsilon.slu.se/21284/>

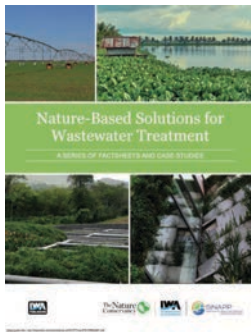

Nature-Based Solutions for Wastewater Treatment

A Series of Factsheets and Case Studies

While there is growing interest in low-cost sanitation solutions which harness natural systems, it can be difficult for wastewater utility managers to understand under what conditions such nature-based solutions (NBS) might be applicable and how best to combine traditional infrastructure, for example an activated sludge treatment plant, with an NBS such as treatment wetlands. This book serves as a compilation of technical references, case examples and guidance for applying NBS for treatment of domestic wastewater and enables a wide variety of stakeholders to understand the design parameters, removal efficiencies, costs, co-benefits for both people and nature and trade-offs for consideration in their local context. *By Cross, K., Tondera, K., Rizzo, A., Andrews, L., Pucher, B., Istenič, D., Karres, N., McDonald, R. (Eds.) (2021). IWA Publishing. Free PDF available at: <https://iwaponline.com/ebooks/book/834/Nature-Based-Solutions-for-Wastewater-TreatmentA>*



Faecal Sludge Management

Systems Approach for Implementation and Operation

This is the first book to compile the current state of knowledge on faecal sludge management. It addresses the organisation of the entire faecal sludge management service chain, from the collection and transport of sludge, to the current state of knowledge of treatment options and the final end use or disposal of treated sludge. It presents an integrated approach that brings together technology, management and planning, based on Sandec's 20 years of experience in the field. It also discusses important factors to consider when evaluating and upscaling new treatment technology options. The book is designed for undergraduate and graduate students, engineers and practitioners in the field who have some basic knowledge of environmental and/or wastewater engineering. *Available also in Spanish and French. By Strande, L., Ronteltap, M. and Brdjanovic, D. (Eds.) (2014). IWA Publishing. Free PDF available at: www.sandec.ch/fsm_book*

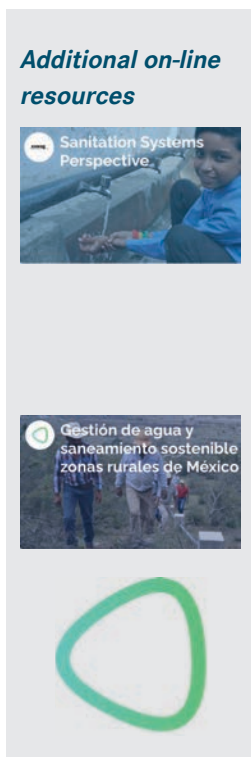

The following on-line tools provide useful guidance and downloadable resources that complement the documents listed above.

Sanitation Systems Perspective (eCompendium)

The digital, interactive version of eawag's Compendium (2nd Edition) is structured around the different sanitation systems and their technologies. Equipped with additional case studies and resources, this online version offers a variety of perspectives, including topics beyond the Compendium's systems and technologies. It is an integral part of the SSWM Toolbox. *Available at: <https://sswm.info/perspective/sanitation-systems-perspective>*

...and sustainable water and sanitation management focusing on rural areas in Spanish: <https://sswm.info/es/perspective/gestion-de-agua-y-saneamiento-sostenible-en-zonas-rurales-de-mexico>

Sustainable Sanitation and Water Management Toolbox

The SSWM Toolbox is the most comprehensive collection of tools and approaches of water management and sustainable sanitation available. It combines planning tools and software and links them with publications, articles and web links, case studies and training material. *Available at: www.sswm.info*

Compendium Terminology

Sanitation Systems

The Compendium defines sanitation as a multi-step process in which human excreta and wastewater are managed from the point of generation to the point of use or ultimate disposal. A Sanitation System is a context-specific series of technologies and services for the management of these wastes (or better resources), i.e. for their collection, containment, conveyance, transformation, utilisation or disposal. A sanitation system is comprised of products (wastes/resources) that travel through Functional Groups which contain Technologies that can be selected according to the context. By selecting a Technology for each product from each applicable Functional Group, one can design a logical Sanitation System. A sanitation system also includes the management, operation and maintenance (O&M) required to ensure that the system functions safely and sustainably.

A System Template defines a suite of compatible technology combinations from which a system can be designed. In Part 1 of the Compendium, six different sanitation system templates are described. A detailed explanation of how system templates function and how they are used is given in the section “Using the System Templates” on pp. 18-21.

Products

Products are materials that are also called ‘wastes’ or ‘resources’. Some products are generated directly by humans (e.g. Urine and Faeces), others are required for the functioning of technologies (e.g. Flushwater to move Excreta through sewers) and some are generated as a function of storage or treatment (e.g. Sludge).

For the design of a robust sanitation system, it is necessary to define all of the products that are flowing into (inputs) and out of (outputs) each of the sanitation technologies in the system. The products referenced within this text are described below.

Anal Cleansing Water is water used to cleanse oneself after defecating and/or urinating; it is generated by those who use water, rather than dry material, for anal cleansing. The volume of water used per cleaning typically ranges from 0.5 L to 3 L.

Biochar is a solid material obtained from Carbonisation, the thermochemical conversion of biomass in an oxygen-limited environment. Biochar derived from the Carbonisation of sludge, faeces and/or organic waste may be applied to soils in order to improve soil properties and crop yields, as well as acting as a carbon sink to reduce climate change impacts

Biogas is the common name for the mixture of gases released from anaerobic digestion. Biogas is comprised of methane (50 to 75%), carbon dioxide (25 to 50%) and varying quantities of nitrogen, hydrogen sulphide, water vapour and other components. Biogas can be collected and burned for fuel (like propane).

Biomass refers to plants or animals cultivated using the water and/or nutrients flowing through a sanitation system. The term Biomass may include fish, insects, vegetables, fruit, forage or other beneficial crops that can be utilised for food, feed, fibre and fuel production.

Blackwater is the mixture of Urine, Faeces and Flushwater along with Anal Cleansing Water (if water is used for cleansing) and/or Dry Cleansing Materials (see Figure 1). Blackwater contains the pathogens of Faeces and the nutrients of Urine that are diluted in the Flushwater.

Brownwater is the mixture of Faeces and Flushwater, and does not contain Urine. It is generated by Urine-Diverting Flush Toilets (U.3) and therefore, the volume depends on the volume of the Flushwater used. The pathogen and nutrient load of Faeces is not reduced, only diluted by the Flushwater. Brownwater may also include Anal Cleansing Water (if water is used for cleansing) and/or Dry Cleansing Materials (see Figure 1).

Compost is decomposed organic matter that results from a controlled aerobic degradation process. In this biological process, microorganisms (mainly bacteria and fungi) decompose the biodegradable waste components and produce an earth-like, odourless,

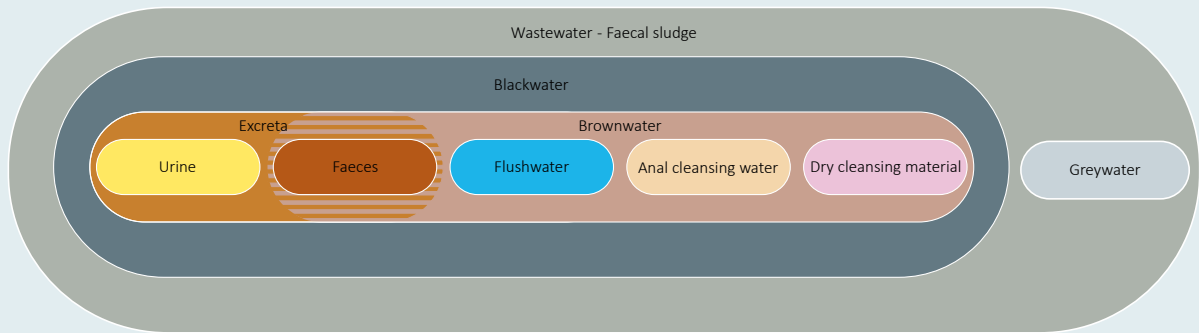

Figure 1: Possible inputs into the sanitation service chain. Note that several treatment processes can also incorporate other wastes (e.g. food waste, animal manure and organic fractions from industrial processes).

brown/black material. Generally, Excreta or Sludge should be composted under thermophilic conditions (up to 65°C) and long enough (over 4 months) in order to be sanitised sufficiently for safe agricultural use. Under these conditions, considerable pathogen reduction can normally be achieved.

Compost has excellent soil-conditioning properties and is a variable nutrient content. It has still degradable organic matter and slowly transforms in the soil to humus, which is composed of relatively stable organic components formed by humic substances, including humic acids, fulvic acids, hmatomelanic acids and humins (all carbon-based macromolecular substances). During the decomposition process, nutrients are slowly released, which are then available to plants.

Dried Faeces are Faeces that have been dehydrated until they become a dry, crumbly material. Dehydration takes place by storing Faeces in a dry environment with good ventilation, high temperatures and/or the presence of absorbent material. Very little degradation occurs during dehydration and this means that the Dried Faeces are still rich in organic matter. However, Faeces reduce by around 75 % in volume during dehydration and most pathogens die off. There is a small risk that some pathogenic organisms can be reactivated under the right conditions, particularly, in humid environments.

Dry Cleansing Materials are solid materials used to cleanse oneself after defecating and/or urinating (e.g. paper, leaves, corncobs, rags or stones). Depending on the system, Dry Cleansing Materials may be collected and separately disposed of. Menstrual hygiene products, such as sanitary napkins and tampons are not included

in this Compendium. In general (though not always), they should be collected and disposed of as solid waste.

Effluent is the general term for a liquid that leaves a technology, typically after Blackwater or Sludge has undergone solids separation or some other type of treatment. Effluent originates at either a Collection and Storage or a (Semi-) Centralised Treatment technology. Depending on the type of treatment and its further use, the Effluent may comply with reuse or disposal standards or may require further treatment.

Excreta consists of Urine and Faeces that is not mixed with any Flushwater. Excreta is small in volume, but concentrated in both nutrients and pathogens. Depending on the quality of the Faeces, it has a soft or runny consistency. A person produces about 350 to 600 L per year, the sum of Urine and Faeces.

Faeces refers to (semi-solid) excrement that is not mixed with Urine or water. Depending on one's diet, each person produces approximately 50L per year of faecal matter. Fresh Faeces contain 70 to 80% water. Of the total nutrients excreted, the Faeces from one person excreted over one year contains on average about 0.6 kg of nitrogen N, 0.2 kg of phosphate (P) and 0.3 kg of potassium (K, Rose et al., 2015). Faeces can contain a large number of pathogens.

Flushwater is the water discharged into the User Interface to transport the content and/or clean it. Freshwater, rainwater, recycled Greywater, or any combination of the three can be used as a Flushwater source.

Greywater is the total volume of water generated from washing food, clothes and dishware, as well as from bathing and showering, but does not include material from toilets. It may contain traces of Excreta (e.g. from washing diapers) and, therefore, also pathogens. Pathogens may also originate from food waste. Greywater accounts for approximately 65 % of the wastewater produced in households with flush toilets.

Organics refers to biodegradable plant material (organic waste) that must be added to some technologies in order for them to function properly (e.g. Co-Composting, T.17). Organic degradable material can include, but is not limited to, leaves, grass and market waste. Although other products in this Compendium contain organic matter, the term Organics refers to undigested plant material.

Pre-Treatment Products are materials separated from Blackwater, Brownwater, Greywater or Sludge in preliminary treatment units, such as screens, grease traps or grit chambers (see PRE, p. 76). Substances like fats, oil, grease and various solids (e.g. sand, fibres and trash), can impair transport and/or treatment efficiency through clogging and wear. Therefore, early removal of these substances is crucial for the durability of a sanitation system.

Sludge is a mixture of solids and liquids, containing mostly Excreta and water, in combination with sand, grit, metals, trash and/or various chemical compounds. A distinction can be made between faecal Sludge and wastewater Sludge. Faecal Sludge comes from onsite sanitation technologies, i.e. it has not been transported through a sewer. It can be raw or partially digested, a slurry or semisolid, and results from the Collection and Storage/Treatment of Excreta or Blackwater, with or without Greywater. For a more detailed characterisation of faecal Sludge refer to Strande et al., 2014 (see Sector Development Tools, p. 10). Wastewater Sludge (also referred to as sewage Sludge) is Sludge that originates from sewer-based wastewater collection and (Semi-) Centralised Treatment processes.

The Sludge composition will determine the type of treatment that is required and the end-use possibilities.

Stored Urine is Urine that has been hydrolysed naturally over time, i.e. the urea has been converted by enzymes into ammonia and bicarbonate. Stored Urine has a pH of approximately 9. Most pathogens cannot

survive at this pH. After six months of storage, the risk of pathogen transmission is considerably reduced.

Stormwater is the general term for the rainfall runoff collected from roofs, roads and other surfaces before flowing towards low-lying land. It is the portion of rainfall that does not infiltrate into the soil.

Urine is the liquid produced by the body to rid itself of urea and other waste products. In this context, the Urine product refers to pure Urine that is not mixed with Faeces or water. Depending on one's diet, human Urine collected from one person during one year (approx. 300 to 550L) contains 3 to 4 kg of nitrogen (N), 0.3 kg of phosphorus (P) and 0.7 kg of potassium (K, Rose et al., 2015). Few pathogens are excreted in the urine; however, urine can be contaminated with faeces in urine diverting sanitation systems.

Wastewater is typically defined as the mixture of excreta and all used water, e.g. excreta, flushwater, cleansing materials and greywater, collected in a holding tank or through a sewer network. It contains the pathogens of faeces and the nutrients of urine, diluted with large volumes of water from the greywater. Wastewater from multiple sources, including domestic and industrial buildings, is generally collected together. In some cases, wastewater is mixed with stormwater during transport to the treatment plant.

Functional Groups

A functional group is a grouping of technologies that have similar functions. There are five different functional groups from which technologies can be chosen to build a system.

The five functional groups are:

- U User Interface** (Technologies U.1-U.4): Red
- S Collection and Storage/Treatment** (Technologies S.1-S.6): Orange
- C Conveyance** (Technologies C.1-C.5): Yellow
- T (Semi-) Centralised Treatment** (Technologies PRE, T.1-T.19, POST): Green
- D Reuse and/or Disposal** (Technologies R.1-R.12): Blue

Each functional group has a distinctive colour; technologies within a given functional group share the same colour code so that they are easily identifiable. Also, each technology within a functional group is assigned

a reference code with a single letter and number; the letter corresponds to its functional group (e.g. U for User Interface) and the number, going from lowest to highest, indicates approximately how resource intensive (i.e. economic, material and human) the technology is compared to the other technologies within the group.

U User Interface (U) describes the type of toilet, pedestal, pan, or urinal with which the user comes in contact; it is the way by which the user accesses the sanitation system. In many cases, the choice of User Interface will depend on the availability of water. Note that Greywater and Stormwater do not originate at the User Interface, but may be treated along with the products that originate from it.

S Collection and Storage/Treatment (S) describes the ways of collecting, storing and sometimes treating the products generated at the User Interface. The treatment provided by these technologies is often a function of storage with solid-liquid separation and is usually passive (e.g. requiring no energy input). Thus, products that are ‘treated’ by these technologies often require subsequent treatment before Reuse and/or Disposal.

C Conveyance (C) describes the transport of products from one functional group to another. Although products may need to be transferred in various ways between functional groups, the longest and most important gap is between User Interface or Collection and Storage/Treatment and (Semi-) Centralised Treatment. Therefore, for the sake of simplicity, Conveyance only describes the technologies used to transport products between these functional groups.

T (Semi-) Centralised Treatment (T) refers to treatment technologies that are generally appropriate for large user groups (i.e. neighbourhood to city level applications). The operation, maintenance and energy requirements of technologies within this functional group are generally higher than for smaller-scale technologies at the S level. The technologies are divided into 2 groups: T.1-T.13 are primarily for the treatment of Blackwater, Brownwater, Greywater or Effluent, whereas T.14-T.19 are mainly for the treatment of Sludge. Technologies for pre-treatment and post-treatment are also described (technology information sheets PRE, p. 76 and POST, p. 116).

R Reuse and/or Disposal (R) refers to the methods by which products are ultimately returned to the environment, either as useful resources or reduced-risk materials. Furthermore, products can also be cycled back into a system (e.g. by using treated Greywater for flushing). In contrast to the 2nd Edition of the Eawag Compendium, which refers to the end of the service chain as functional group **D** Use and/or Disposal, this edition refers to this step as **R** Reuse and/or Disposal. It emphasises the importance of reuse.

Sanitation Technologies

Technologies are defined as the specific infrastructure, methods, or services designed to contain and transform products, or to transport products to another functional group. Each of the 48 technologies included in this Compendium is described on a Technology Information Sheet in Part 2. There are between 4 and 19 different technologies (21 including PRE and POST) within each of the five functional groups.

Only those sanitation technologies, which have been proven and tested in the context of low- and middle-income countries, are included. Moreover, they have only been included if they are considered “improved” in regards to the provision of safe, hygienic and accessible sanitation. A wide variety of sanitation technologies in each functional group are either currently under development, exist only as prototypes or are not yet fully mature and available. Examples of the most interesting and promising developments with high potential for implementation in low- and middle-income countries are outlined in the section “Emerging Sanitation Technologies” (pp. 147-155). Hopefully, some of these technologies may be included in the form of a technology information sheet in a future edition of the Compendium.

The Compendium is primarily concerned with systems and technologies directly related to Excreta and does not specifically address Greywater or Stormwater management, although it does show when they can be co-treated with Excreta. This explains why the related Greywater and Stormwater technologies are not described in detail, but are still shown as products in the system templates. For a more comprehensive summary of dedicated Greywater systems and technologies, please refer to Morel et al., 2006.

References & Further Reading

can be found on page 238

A system template defines a suite of compatible and proven technology combinations from which a sanitation system can be designed. The system templates can be used to identify and display complete systems, which take into account the management of all product flows between User Interface and Reuse or Disposal, and to compare the different options that are available in specific contexts.

This first part of the Compendium explains in detail how the system templates are read and used, and includes a presentation of the different templates. It describes the main considerations and the type of applications for which each system template is appropriate.

Following a consultative process in the conception phase of this Compendium, six different system templates emerged as being relevant for utilities in the Wider Caribbean Region. These range from simple (with few technology choices and products) to complex (with multiple technology choices and products). Each system template is distinct in terms of the number of products generated and processed. The six system templates are:

- System 1: Blackwater System with On-site Effluent Infiltration and Off-site Sludge Treatment
- System 2: Blackwater System with On-site Sludge Production and Off-site Effluent/Sludge Treatment
- System 3: Holding Tank System with Motorised Transport to Off-site Treatment
- System 4: Sewered System without On-site Storage
- System 5: Sewered System with Urine Diversion and Off-site Application of Urine
- System 6: Container-based System with Urine Diversion and Transport to Off-site Treatment

These systems have all proven their feasibility in practical applications. Each has its own characteristic advantages and disadvantages, as well as scope of application. The Compendium, however, is not an exhaustive list of technologies and associated systems. In specific cases, technology combinations other than those presented in this document may be applicable.

Although the system templates are predefined, the Compendium user must select the appropriate technology from the options presented. The choice is context-specific and should be made based on the local environment (space, topography, temperature, rainfall, etc.), culture (sitters, squatters, washers, wipers, etc.) and resources (human, financial and material).

Using the System Templates

A sanitation system can be visualised as a matrix of **functional groups** (columns) and **products** (rows) that are linked together where potential combinations exist. Such a graphical presentation gives an overview of the technology components of a system and of all the products that it manages.

Products are successively collected, stored, transported and transformed along different compatible technologies from the five functional groups. The output

of a technology in one functional group, thereby, becomes the input for the next.

It is not always necessary for a product to pass through a technology from each of the five functional groups; however, the ordering of the functional groups should usually be maintained regardless of how many of them are included within the sanitation system.

Figures 2 and 3 explain the structure and elements of a system template.

Figure 2: Explanation of the different columns of a system template

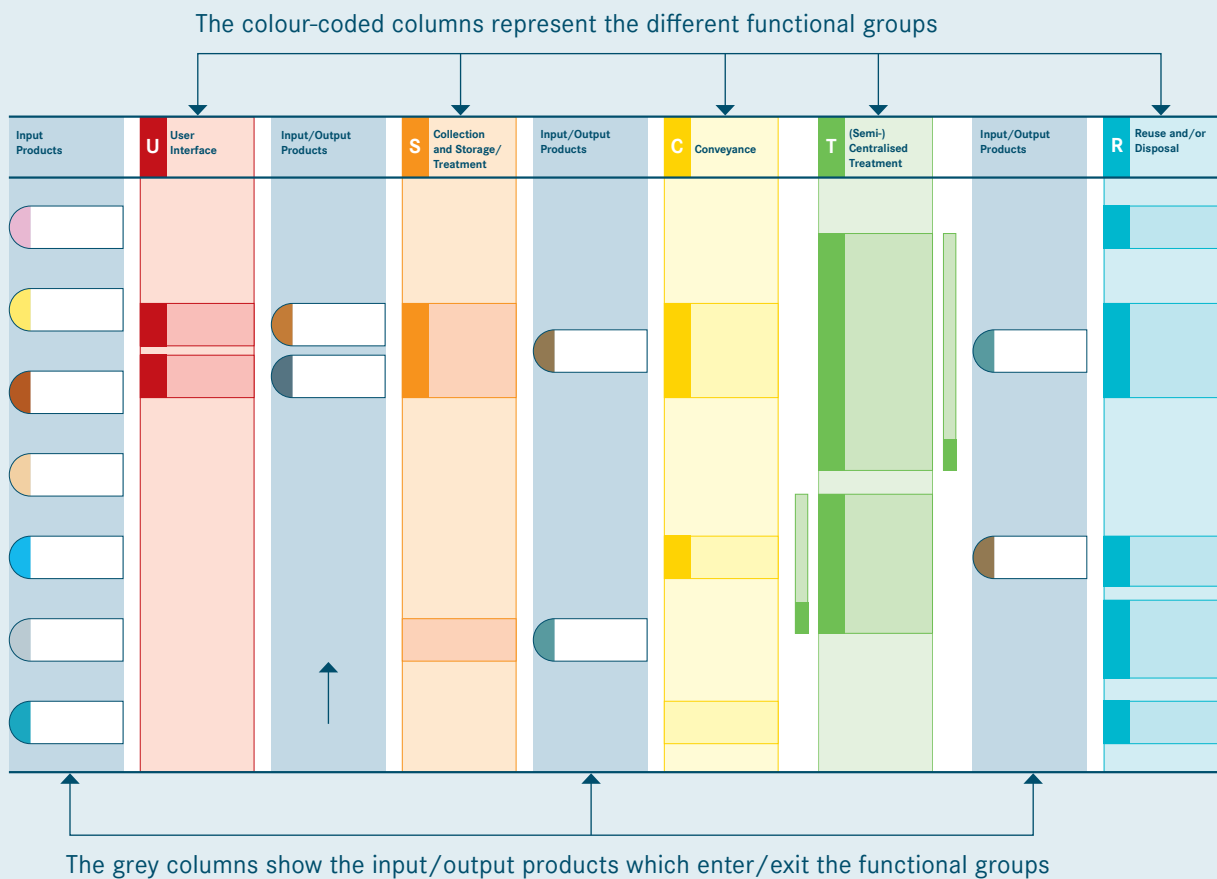

Figure 3: Explanation of the different graphical elements in a system template

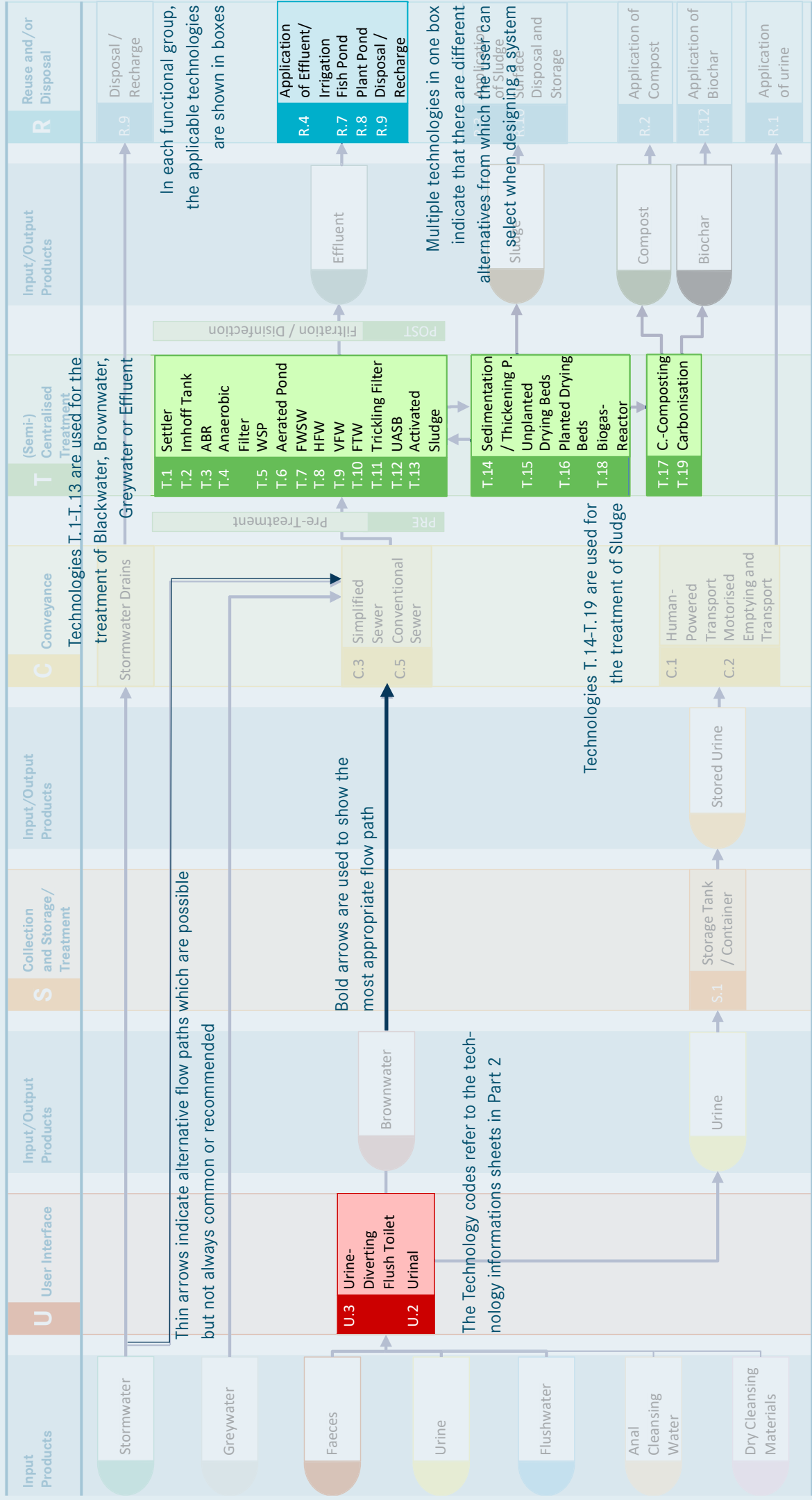

Figure 4: Example of how inputs enter into functional groups and are transformed

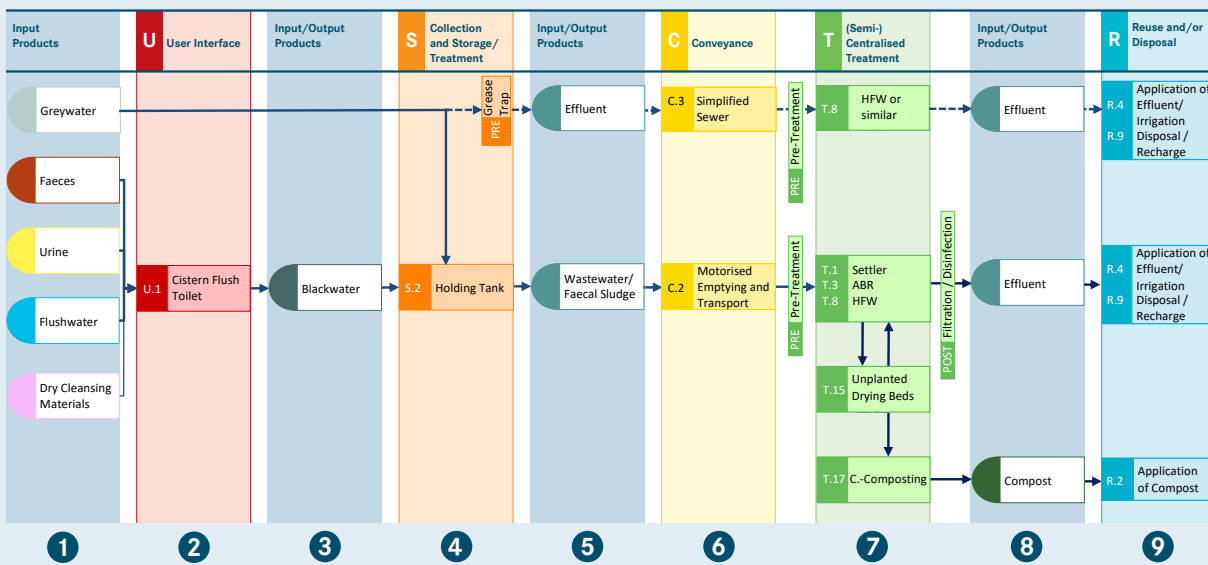

Figure 4 is an example from a system template. It shows how five products (Greywater, Faeces, Urine Flushwater and Dry Cleansing Materials) enter a system and are managed using different sanitation technologies. The following text describes how the products move from left to right through columns 1–9 of the system template.

1 Four inputs (Faeces, Urine Flushwater and Dry Cleansing Materials) enter into 2 functional group U “User Interface” (Cistern Flush Toilet). The Blackwater generated 3 then enters into 4 functional group S “Collection and Storage/Treatment” (Holding Tank). The Holding Tank is a technology for safe storage and containment, but not for treatment. Diluted by Greywater, the output becomes Wastewater/Faecal Sludge 5, entering into 6 functional group C “Conveyance” (Motorised Emptying and Transport) and is conveyed to 7 functional group T “(Semi-) Centralised Treatment”. After Pre-Treatment, three consecutive Treatment Technologies (first a Settler, then an ABR followed by a Horizontal Flow Wetland) process and separate the solid from the liquid phase and transform the incoming blackwater to liquid Effluent and Sludge as two distinct products. The latter is processed 7 using Unplanted Drying Beds followed by Co-Composting as the fourth and fifth technology. After Post-Treatment, the effluent as output 8 is conveyed for final 9 functional group R “Reuse and/or Disposal”, where two possibilities exist. Depending on the volume and time of the season, the Effluent can be reused in Irrigation schemes or discharged/infiltrated to Water Disposal/Groundwater

Recharge in water bodies. Depending on the local conditions, needs and preferences, the matured 8 Compost can be applied directly in horticultural production, agriculture or urban greening as soil conditioner or packed in bags and temporarily stored for commercialisation, e.g. for use in home gardens (Application of Compost).

If there is a possibility of collecting 1 Greywater separately, it should be recovered and treated for reuse (On- or Off-site). The separate piping system should include an 4 On-Site Pre-treatment, such as a grease trap, to prevent clogging induced by cooking-fat. The 5 Effluent is 6 conveyed to 7 functional group T. After Treatment, including in this case Pre-Treatment followed by a Horizontal Flow Wetland, the 8 Effluent can be 9 reused in Irrigation schemes or discharged/infiltrated to Water Disposal/Groundwater Recharge in water bodies. For all Systems, the separate collection of Greywater is particularly interesting for new housing developments: even if reuse cannot be implemented immediately, it remains a valuable option for future upgrade.

Steps for selecting sanitation options using the system templates

The six system templates present the most logical combinations of technologies. However, the technologies and associated links are not exhaustive and planners should not lose a rational engineering perspective when trying to find the best possible solution for a specific context. Designers should attempt to minimise redundancy, optimise existing infrastructure and make use of local resources, while taking into account the local enabling environment (especially fac-

tors, such as skills and capacities, socio-cultural acceptance, financial resources and legal requirements). The following procedure can be used to pre-select potential sanitation options:

1. Identify the products that are locally generated and/or available (e.g. Anal Cleansing Water, Flushwater or Organics for composting).
2. Identify the system templates that process the defined products.
3. For each template, select one or several technologies from each functional group where there is a technology choice presented (box with multiple technologies); the series of technologies make up a system.
4. Compare the systems and iteratively change individual technologies or use a different system template based on user priorities, the demand for specific end-products (e.g. Compost), economic constraints and technical feasibility.

can then be followed for each of the separate sub-areas and any number of systems can be chosen.

Parts of a sanitation system may already exist; in that case, the aim of the planners and engineers is to integrate the existing infrastructure or services, while maintaining flexibility, with user satisfaction as the primary goal. Further valuable criteria and aspects relevant for the planning process are provided in “Part 3: Cross-Cutting Issues for Planning and Decision Making”.

A blank system template can be downloaded from www.sandec.ch/compendium. It can be printed and used to sketch site-specific sanitation systems, for example, when discussing different options with experts or stakeholders in a workshop. A PowerPoint template is also available for downloading that has pre-defined graphical elements (such as products, technologies and arrows), facilitating the preparation of customised sanitation system drawings.

It may be useful to divide the planning zone under consideration into sub-areas so that each one has within it similar characteristics and conditions. The procedure

The six system templates are presented and described on the following pages. Each system template is explained in detail.

Selection of sanitation options in the CLUES planning approach

In Community-Led Urban Environmental Sanitation Planning (CLUES), the fifth of seven steps is the “Identification of Service Options”.

The CLUES guidelines (see Sector Development Tools, p. 8) give a detailed description of how the Compendium can be used in participatory expert and community workshops to select and discuss appropriate sanitation solutions for an area.

www.sandec.ch/clues

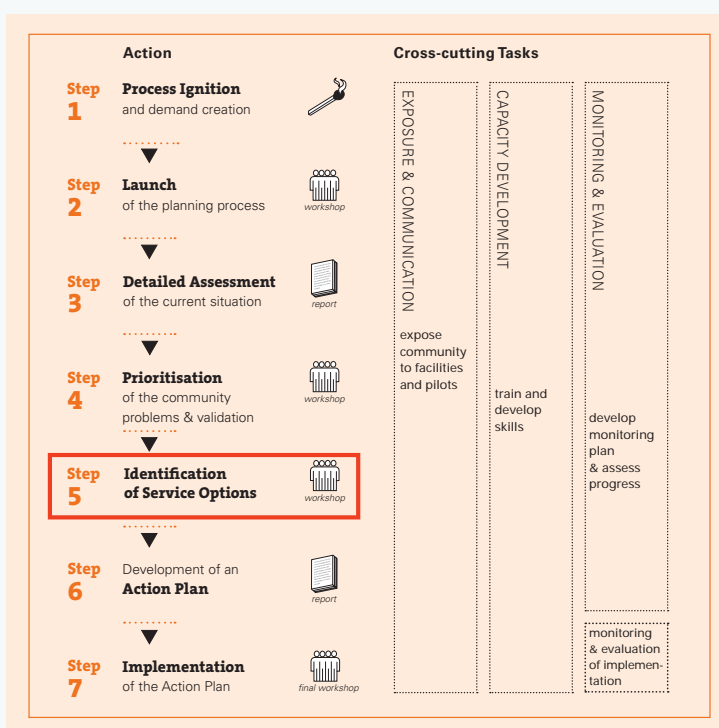
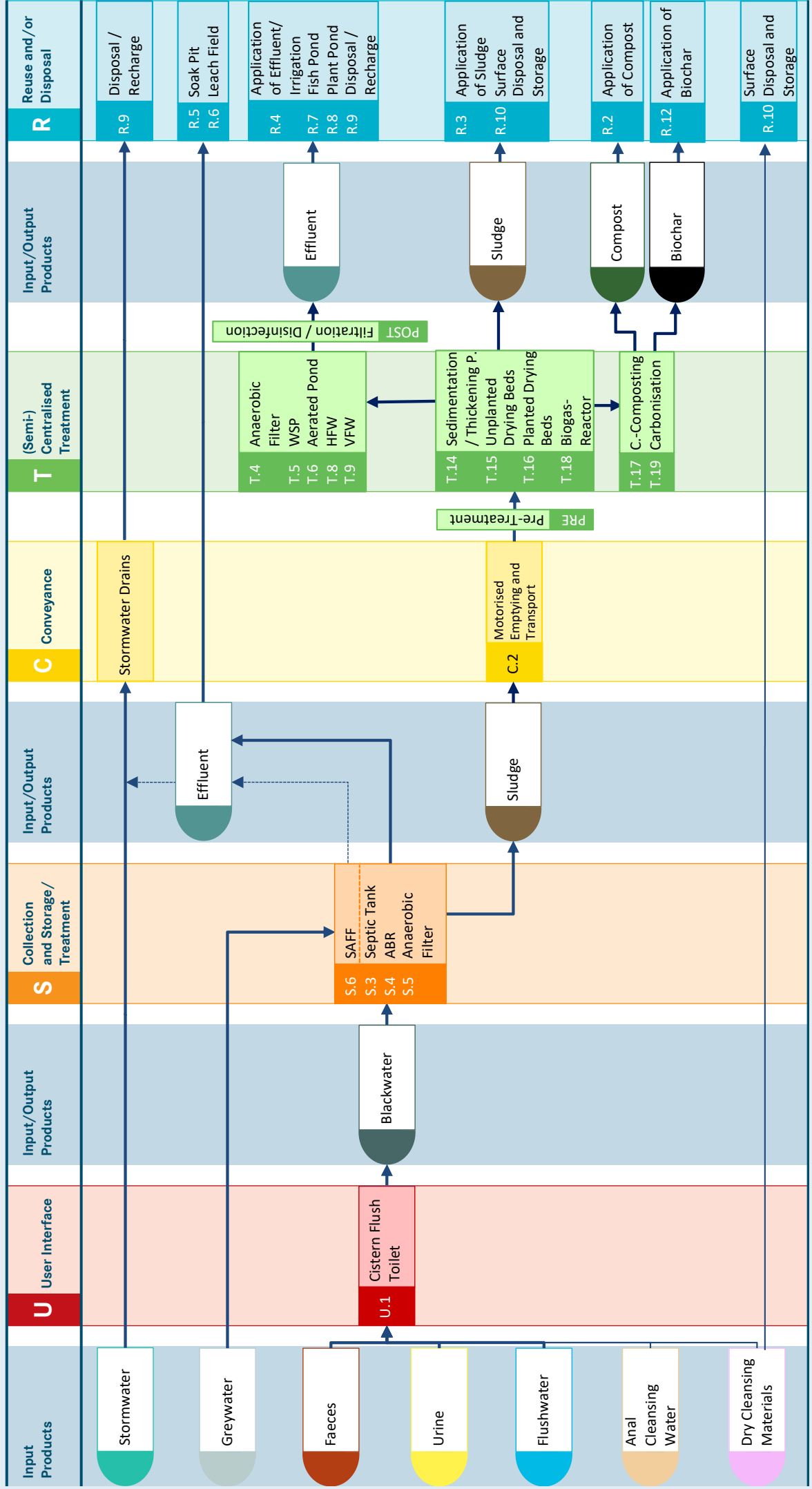
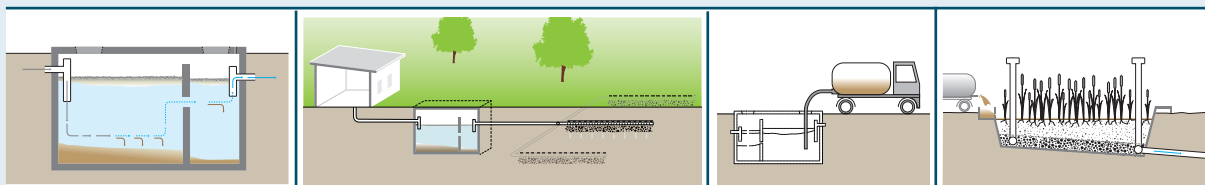

Figure 5: The seven steps of CLUES

Sanitation System 1: Blackwater System with On-site Effluent Infiltration and Off-site Sludge Treatment



System 1: Blackwater System with On-site Effluent Infiltration and Off-site Sludge Treatment



This is a water-based system that requires a flush toilet and a Collection and Storage/Treatment technology that is appropriate for receiving large quantities of water. Inputs to the system can include Faeces, Urine, Flushwater, Anal Cleansing Water, Dry Cleansing Materials and Greywater. A Cistern Flush Toilet (U.1) is used as User Interface technology. As for all other systems, a Urinal (U.2) could additionally be used, but is not shown here. The User Interface is directly connected to a Collection and Storage/Treatment technology for the Blackwater, becoming Wastewater if the Greywater is also connected. Collection and Storage/Treatment technologies are either a Septic Tank (S.3), an Anaerobic Baffled Reactor (ABR, S.4), an Anaerobic Filter (S.5) or a Submerged Aerated Fixed-Film Filter (S.6). The anaerobic processes (S.3-S.5) provide an initial reduction of the organic and (to a lesser extent) the pathogen load. The aerobic process (S.6) reduces both even further. However, for the safe application of the Effluent in nearby gardens and lands, appropriate protective measures following the WHO Guidelines for the safe use of Effluent in agriculture have to be followed and respected. If soil and groundwater conditions allow, Effluent generated from the Collection and Storage/Treatment can be directly diverted to the ground for disposal through a Soak Pit (R.5) or a Leach Field (R.6). Although it is not recommended, the Effluent can also be discharged into the Stormwater drainage network for Water Disposal/Groundwater Recharge (R.9). This should only be considered if there is no capacity for on-site infiltration or transportation off-site and the on-site treatment is upgraded (e.g. retrofitting a septic tank with aeration (S.6) and/ or further (POST) post-treatment/sanitation, see consideration below). The Sludge that is generated from the Collection and Storage/Treatment technology must be removed and transported for further treatment. The Conveyance technology that can be used is Motorised Emptying and Transport (C.2). As the Sludge is highly pathogenic prior to treatment, human contact and direct agricultural application should be avoided. The Sludge that is removed should be transported to a dedicated Sludge treatment facility (T.14-T.19).

(Semi-) Centralised Treatment technologies (T.1-T.19) produce both Effluent and Sludge, which may require further treatment prior to Reuse and/or Disposal. For example, Effluent from a Sludge treatment facility could be co-treated with wastewater in an Anaerobic Filter (T.4), Waste Stabilisation Ponds (T.5), Aerated Pond (T.6) or Wetlands (T. 8-T.9).

Options for the Reuse and/or Disposal of the treated Effluent include Application of Effluent/Irrigation (R.4), Fish Ponds (R.7), Floating Plant Ponds (R.8) or discharge to a water body (Water Disposal/Groundwater Recharge, R.9). After adequate treatment, Sludge can either be used directly in agriculture (R.3), brought to a Storage/Disposal site (R.10) or converted into value-added products, such as Compost or Biochar by other technologies (T.17 and T.19).

Considerations This system is only appropriate in areas where desludging services are available and affordable and where there is an appropriate way to dispose of the Sludge. For the infiltration technologies to work, there must be sufficient available space and the soil must have a suitable capacity to absorb the Effluent. If this is not the case, refer to System 4 (Blackwater System with Sewered Transport to Off-site Treatment). The system requires a constant source of water. This water-based system is suitable for Anal Cleansing Water inputs and, since the solids are settled and decomposed onsite, easily degradable Dry Cleansing Materials can also be used. However, rigid or non-degradable materials (e.g. leaves, rags, etc.) could clog the system and cause problems with emptying and, therefore, should not be used. In cases when Dry Cleansing Materials are collected separately from the flush toilets, they should be disposed of in an appropriate way (e.g. be collected with the domestic solid waste for Surface Disposal, R.10). The capital investment for this system is considerable (excavation and installation of an onsite storage and infiltration technology), but the costs can be shared by several households if the system is designed for a larger number of users.

Sanitation System 2: Blackwater System with On-site Sludge Production and Off-site Sludge Treatment

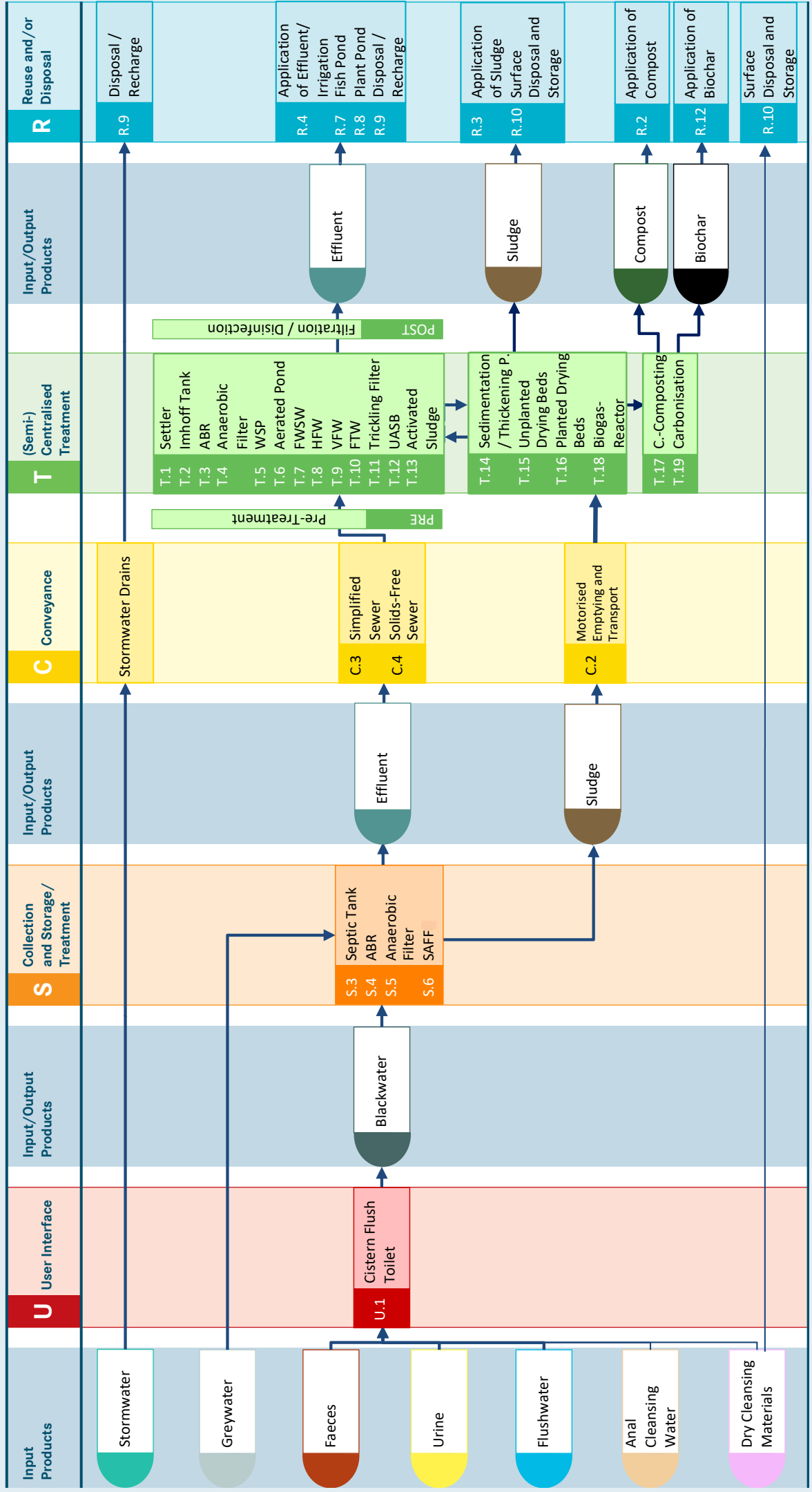

System 2: Blackwater System with On-site Sludge Production and Off-site Sludge Treatment

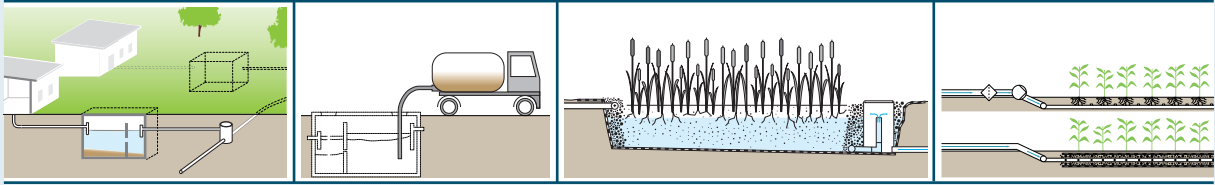

This system is characterised by the use of a household-level technology for the solid-liquid separation of blackwater (onsite primary treatment) and a sewer network to a (Semi-) Centralised Treatment facility. The sludge is removed regularly, depending on the sludge accumulation, through Motorised Emptying (C.2). Inputs to the system can include Faeces, Urine, Flushwater, Anal Cleansing Water, Dry Cleansing Materials and Greywater.

This system is comparable to System 1, except that the management of the Effluent generated during Collection and Storage/Treatment of the Blackwater is different: the Effluent from Septic Tanks (S.3), Anaerobic Baffled Reactors (S.4), Anaerobic Filters (S.5) or Submerged Aerated Fixed-Film Reactor (S.6) is transported to a (Semi-) Centralised Treatment facility via a sewer network (C.3 - C.5). Because the Collection and Storage/Treatment units do separate the solids from the liquid phase, the Effluent is free from settleable solids and, thus, suitable for simplified (C.3) or solid-free (C.4) sewers. To remain free from settleable solids, the Collection and Storage/Treatment technology must be desludged periodically.

At the treatment facility, the Effluent is treated using a combination of the technologies T.1-T.13. As in System 3, the Sludge from the Collection and Storage/Treatment technology must be further treated in a dedicated Sludge treatment facility (T.14-T.19).

(Semi-) Centralised Treatment technologies (T.1-T.19) produce both Effluent and Sludge, which may require further treatment prior to Reuse and/or Disposal.

Options for the Reuse and/or Disposal of the treated Effluent include Application of Effluent/Irrigation (R.4), Fish Ponds (R.7), Floating Plant Ponds (R.8) or discharge to a water body (Water Disposal/Groundwater Recharge, R.9). After adequate treatment, Sludge can either be used directly in agriculture (R.3), brought to a Storage/Disposal site (R.10) or converted into value-added products, such as Compost or Biochar by other technologies (T.17 and T.19).

Considerations This system is especially appropriate for urban settlements where the soil is not suitable for the infiltration of Effluent. Since the sewer network can be designed shallow and (ideally) watertight, it is also applicable for areas with a high groundwater table. This system can be used as a way of upgrading existing, under-performing Collection and Storage/Treatment technologies (e.g. Septic Tanks) by providing additional treatment off-site.

The success of this system depends on the operation and maintenance of the sewer network and requires commitment and responsible action by the users and the utility/service provider. In the absence of a utility service, a person or organisation can be made responsible on behalf of the users. In the case of simplified sewers (C.3 or C.4) managed by the community, there must be an affordable and systematic method for desludging the interceptors since one user's improperly maintained tank could adversely impact the entire sewer network. Also important is a well-operated and properly maintained treatment facility. In some cases, this will be managed at the municipal or regional level. In the case of a small-scale solution for a local settlement, operation and maintenance responsibilities could also be organised on the community or condominium level.

Since the solids are settled and digested onsite, easily degradable Dry Cleansing Materials can be used. However, rigid or non-degradable materials (e.g. leaves, rags, or wet wipes) could clog the system and cause problems with emptying and, therefore, should not be used. In cases when Dry Cleansing Materials are separately collected, they should be disposed of in an appropriate way (e.g. Surface Disposal, R.10).

With the off-site transport of the Effluent to a (Semi-) Centralised Treatment facility, the capital investment for this system is considerable. Installation of an on-site Collection and Storage/Treatment technology may be costly for the user, but the design and installation of a Simplified or Solids-Free Sewer will be considerably less expensive than a Conventional Gravity Sewer network. The off-site treatment plant itself is also an important cost factor, particularly if there is no pre-existing facility to which the sewer can be connected. More information on the costing of sanitation systems is provided in Part 3.

Sanitation System 3: Holding Tank System with Motorised Transport to Off-site Treatment

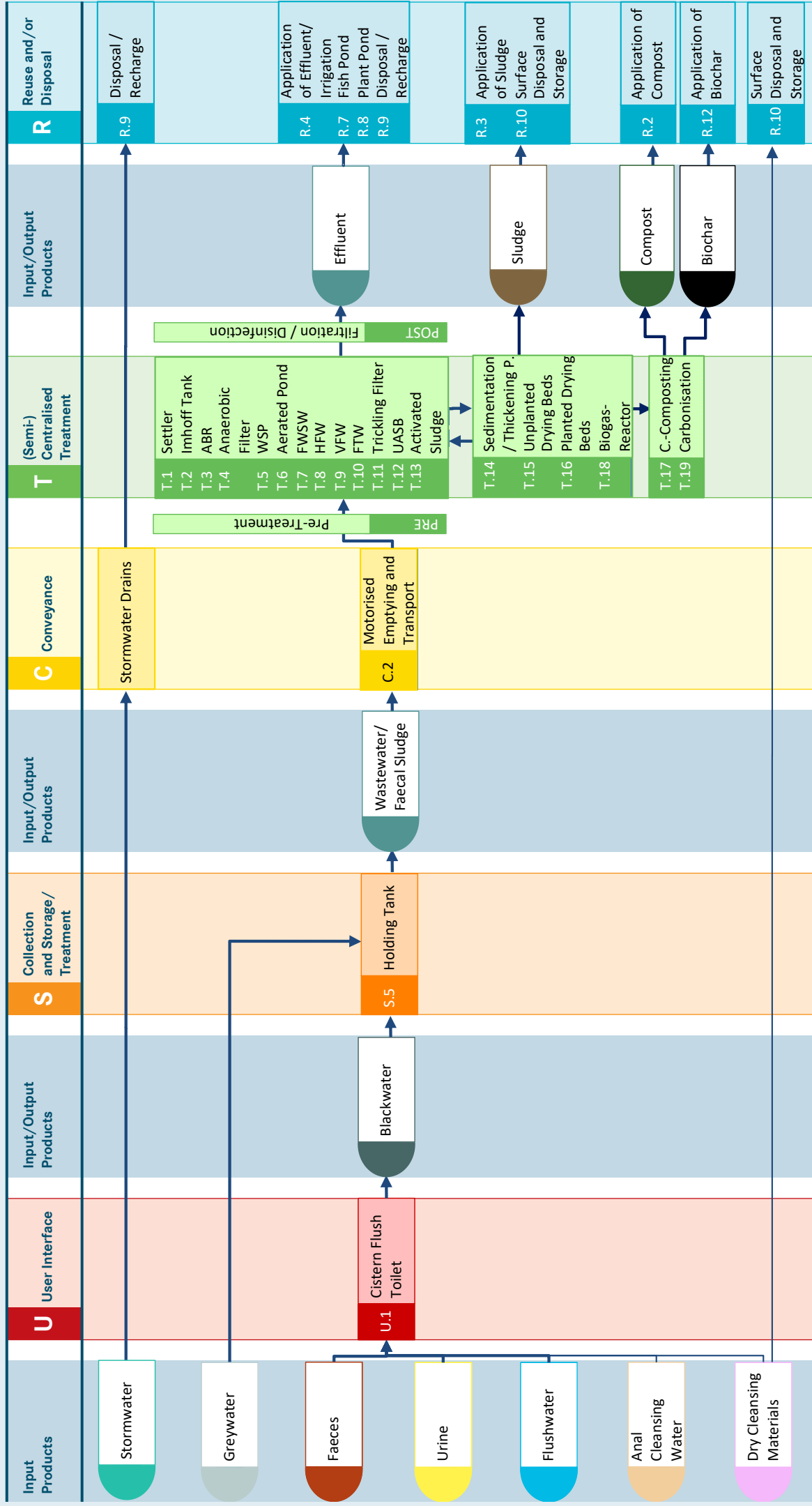

System 3: Holding Tank System with Motorised Transport to Off-site Treatment

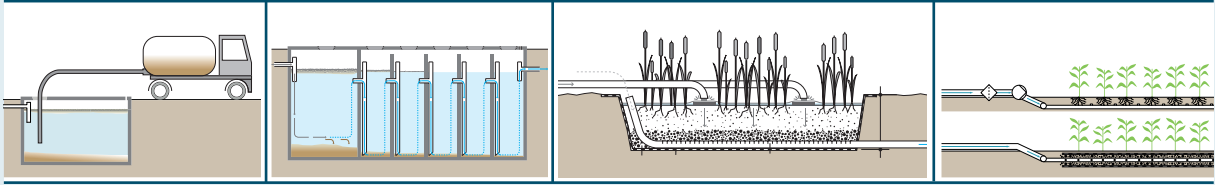

This system is characterised by collecting blackwater on-site in a Holding Tank (S.2), which is regularly serviced by Motorised Emptying and Transport (C.2) for off-site (Semi-) Centralised Treatment (T.1-T.19).

This technology often is the only choice in non-sewered settlements where on-site conditions do not permit any effluent infiltration from a septic tank or other non-containing technologies.

The Blackwater may include Faeces, Urine, Flushwater, Anal Cleansing Water, Dry Cleansing Materials and Greywater. The Blackwater is treated off-site, using a combination of selected technologies (T.1-T.13) depending on local conditions and circumstances. Well-managed screening as pre-treatment (PRE) is necessary. The (Semi-) Centralised Treatment technologies produce both Effluent and Sludge. The sludge requires further treatment (T.14 -T.19) prior to Reuse and/or Disposal.

Options for the Reuse and/or Disposal of the treated Effluent include Application of Effluent/Irrigation (R.4), Fish Ponds (R.7), Floating Plant Ponds (R.8) or discharge to a water body (Water Disposal/ Groundwater Recharge, R.9). After adequate treatment, Sludge can either be used directly in agriculture (R.3), brought to a Storage/Disposal site (R.10) or converted into value-added products, such as Compost or Biochar by other technologies (T.17 and T.19).

Considerations This system is particularly suitable for urban settlements where effluent from on-site treatment systems cannot be discharged into a sewer system and infiltration into the ground is not permitted or possible.

As the Holding Tank does not perform any treatment, the success of this system depends on a reliable Emptying and Transport service with vacuum trucks, enforcement of regulations against the illegal discharge of truck loads (particularly to surface water bodies) and an effective and transparent monitoring. A well-operated and properly maintained facility for off-site treatment of the holding tank content (ideally including safely managed reuse of the treatment products) is a prerequisite for this sanitation system. In some cases, treatment facilities are utility-managed at the municipal or regional level. As mentioned for System 2, responsibilities for the operation and maintenance of a small-scale solution in for a local settlement could also be organised on the community or condominium level.

If Dry Cleansing Materials are separately collected from the flush toilets, they should be disposed of in an appropriate way (e.g. Surface Disposal, R.10). The system is vulnerable to the entry of rigid or non-degradable materials, such as plastics, rubber and menstrual hygiene products.

Sanitation System 4: Sewered System without On-site Storage

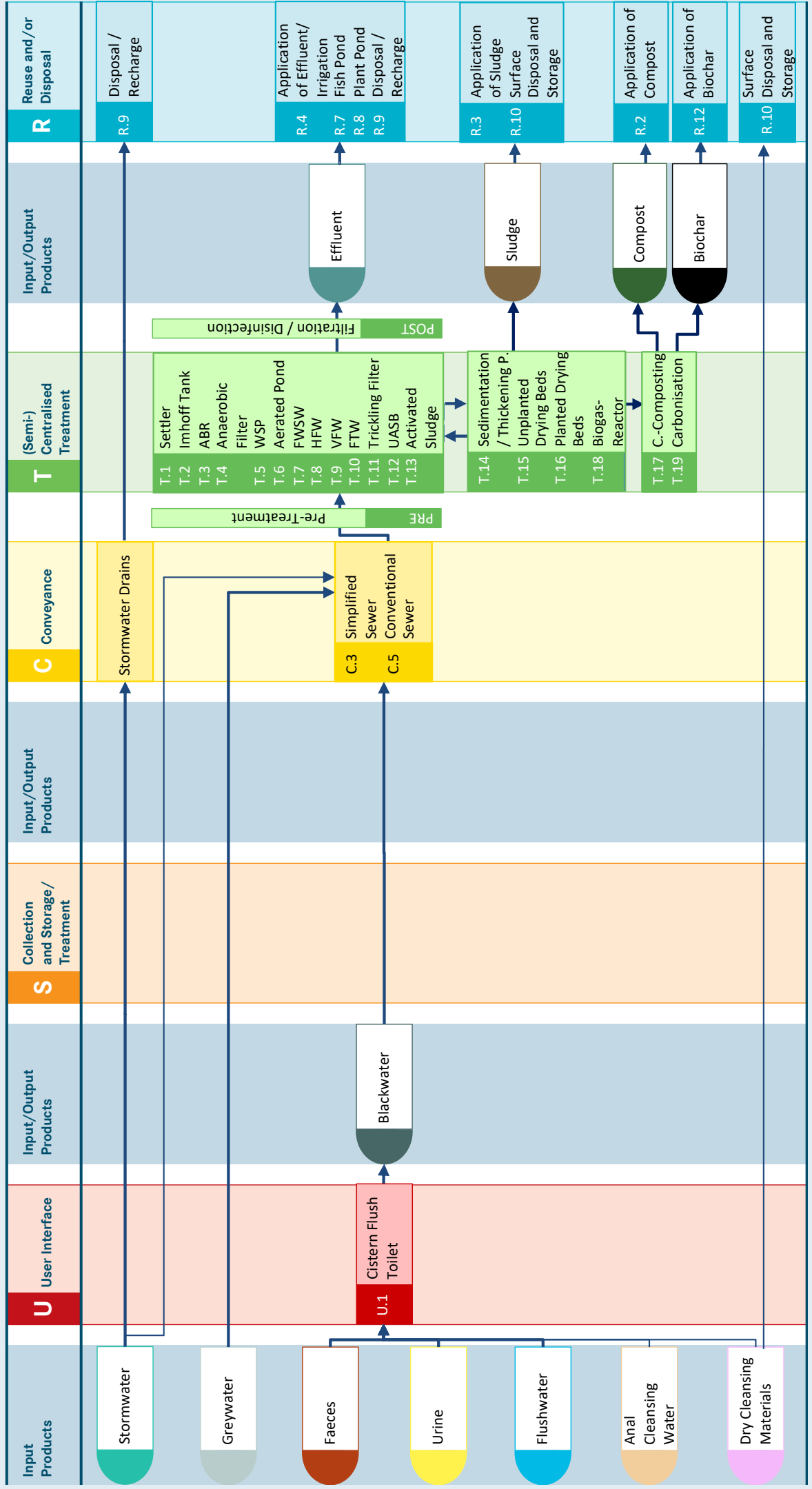

System 4: Sewered System without On-site Storage

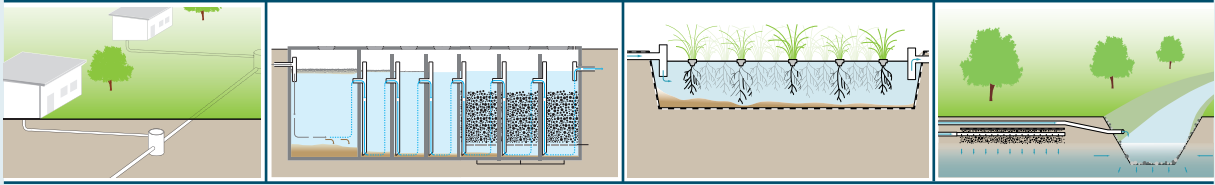

This is a sewerage system in which Blackwater is transported to a Centralised or Semi-Centralised Treatment facility. The important characteristic of this system is that there is no onsite Collection and Storage/Treatment. Inputs to the system include Faeces, Urine, Flushwater, Anal Cleansing Water, Dry Cleansing Materials, Greywater and possibly Stormwater.

A Cistern Flush Toilet (U.1) is used as User Interface technology. The Blackwater that is generated at the User Interface together with Greywater is directly conveyed to a (Semi-) Centralised Treatment facility through a Simplified (C.3) or a Conventional Sewer network (C.5). The inclusion of Greywater in the Conveyance technology helps to prevent solids from accumulating in the sewers.

Stormwater could also be put into the Gravity Sewer network, although this would dilute the wastewater and require Stormwater overflows. Therefore, local retention and infiltration of Stormwater or a separate drainage system for rainwater are the recommended approaches.

A combination of the technologies T.1-T.13 is required for the treatment of the wastewater. Pre-treatment (PRE), such as screening, is required. The Sludge generated from these technologies must be further treated with dedicated Sludge treatment technologies (T.14-T.19) prior to Reuse and/or Disposal.

Options for the Reuse and/or Disposal of the treated Effluent include Application of Effluent/Irrigation (R.4), Fish Ponds (R.7), Floating Plant Ponds (R.8) or discharge to a water body (Water Disposal/ Groundwater Recharge, R.9). After adequate treatment, Sludge can either be used directly in agriculture (R.3), brought to a Storage/Disposal site (R.10) or converted into value-added products, such as Compost or Biochar by other technologies (T.17 and T.19).

Considerations This system is especially appropriate for dense, urban and periurban settlements where there is little or no space for onsite storage technologies or emptying and where a sewer system can be afforded. The system is not well-suited to rural areas with low housing densities. Since the sewer network is (ideally) watertight, it is also applicable for areas with high groundwater tables. There must be a constant supply of water to ensure that the sewers do not become blocked. Dry Cleansing Materials can be handled by the system or they can be collected and separately disposed of (e.g. Surface Disposal, R.10). Disposal of solid waste into the toilet (menstrual hygiene material, wet wipes, plastic objects, etc.) should be avoided.

The capital investment for this system can be very high. Conventional Gravity Sewers require extensive excavation and installation that is expensive, whereas Simplified Sewers are generally less expensive if the site conditions permit a condominal design. Users may be required to pay user fees for the system and its maintenance. Depending on the sewer type and management structure (Simplified vs. Conventional, city-run vs. community-operated), there will be varying degrees of operation or maintenance responsibilities for the homeowner.

This system is most appropriate when there is a high willingness and ability to pay for the capital investment and maintenance costs and where there is a pre-existing treatment facility that has the capacity to accept additional flow.

Sanitation System 5: Sewered System with Urine Diversion and Off-site Application of Urine

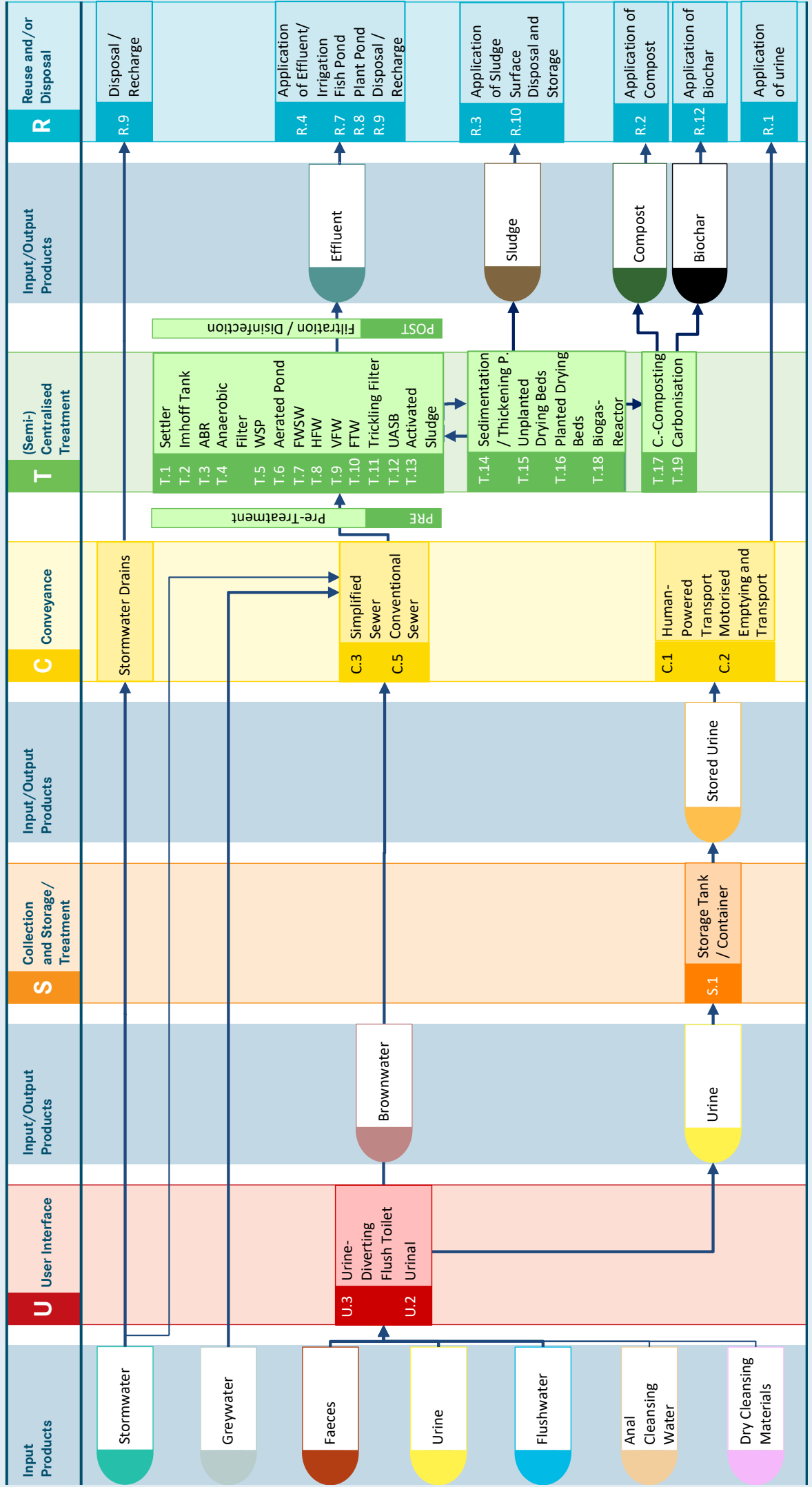

System 5: Sewered System with Urine Diversion and Off-site Application of Urine

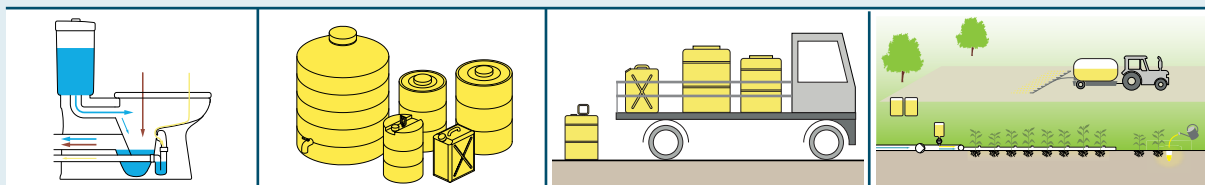

This is a water-based system that requires a Urine-Diverting Flush Toilet (UDFT, U.3) and a sewer network. The UDFT is a special User Interface that allows for source separation of Urine and Faeces. Faeces alone are flushed in the sewer network as Brownwater, while Urine can be collected separately.

Inputs to the system can include Faeces, Urine, Flushwater, Anal Cleansing Water, Dry Cleansing Materials, Greywater and possibly Stormwater. The main User Interface technology for this system is the UDFT (U.3). A Urinal (U.2) can be an additional installation for the effective collection of Urine. Brownwater and Urine are separated at the User Interface. Brownwater is conveyed directly to a (Semi-) Centralised Treatment facility using a Simplified (C.4) or a Conventional Sewer network (C.5). Greywater is also transported in the sewer and is not separately treated.

Stormwater could also be put into the Gravity Sewer network, although this would dilute the wastewater and require Stormwater overflows. Therefore, local retention and infiltration of Stormwater or a separate drainage system for rainwater are the recommended approaches.

Urine diverted at the User Interface is collected in a Storage Tank (S.1). Stored Urine can be handled with little risk because it is nearly sterile. With its high nutrient content, it can be used as a good liquid fertiliser. Stored Urine can be transported for Application of Urine (R.1) in agriculture, using Human-Powered (C.1) or a Motorised Emptying and Transport technology (C.2) – the same way that bulk water or Sludge is transported to fields.

Brownwater is treated at a (Semi-) Centralised Treatment facility, using a combination of the technologies T.1-T.13. The Sludge generated from these technologies must be further treated with dedicated Sludge treatment technologies (T.14-T.19) prior to Reuse and/or Disposal. Options for the Reuse and/or Disposal of the treated Effluent include Application of Effluent/Irrigation (R.4), Fish Ponds (R.7), Floating Plant Ponds (R.8) or discharge to a water body (Water Disposal/Groundwater Recharge, R.9). After adequate treatment, Sludge can either be used directly in

agriculture (R.3), brought to a Storage/Disposal site (R.10) or converted into value-added products, such as Compost or Biochar by other technologies (T.17 and T.19).

Considerations This system is only appropriate when there is a demand for Urine, e.g. in agriculture. Moreover, the User Interface and subsequent handling of the Urine needs to be accepted by the users. Another important aspect is that Urine separation relieves the treatment facility by lowering the nutrient and COD concentration, enabling compliance with discharge standards (e.g. Annex III of the LBS Protocol to the Cartagena Convention), while reducing energy consumption and the complexity of the treatment plant. This system can be adapted for both dense urban and periurban areas. It is not well-suited to rural areas with low housing densities. With special precautions, ensuring the sewer network is watertight, the system is also applicable for areas with high groundwater tables. Dry Cleansing Materials can be handled by the system or they can be collected separately and disposed of (e.g. Surface Disposal, R.10). Disposal of solid waste into the toilet (menstrual hygiene material, wet wipes, plastic objects, etc.) should be avoided. UDFTs made of porcelain are expensive. A more affordable low flush UDFT made of polypropylene is new on the market and offers a business opportunity for local manufacturers. Conventional Gravity Sewers require extensive excavation and installation, which is expensive, whereas Simplified Sewers are generally less expensive if the site conditions permit a condominial design. Users may be required to pay user fees for the system and its maintenance. Depending on the sewer type and management structure (Simplified vs. Conventional, city-run vs. community-operated, Urine transport and Application) there will be varying degrees of operation or maintenance responsibilities for the homeowner.

This system is most appropriate when there is a high willingness and ability to pay for the capital investment and maintenance costs and where there is a pre-existing treatment facility that has the capacity to accept additional flow.

Sanitation System 6: Container-based System with Urine Diversion and Transport to Off-site Treatment

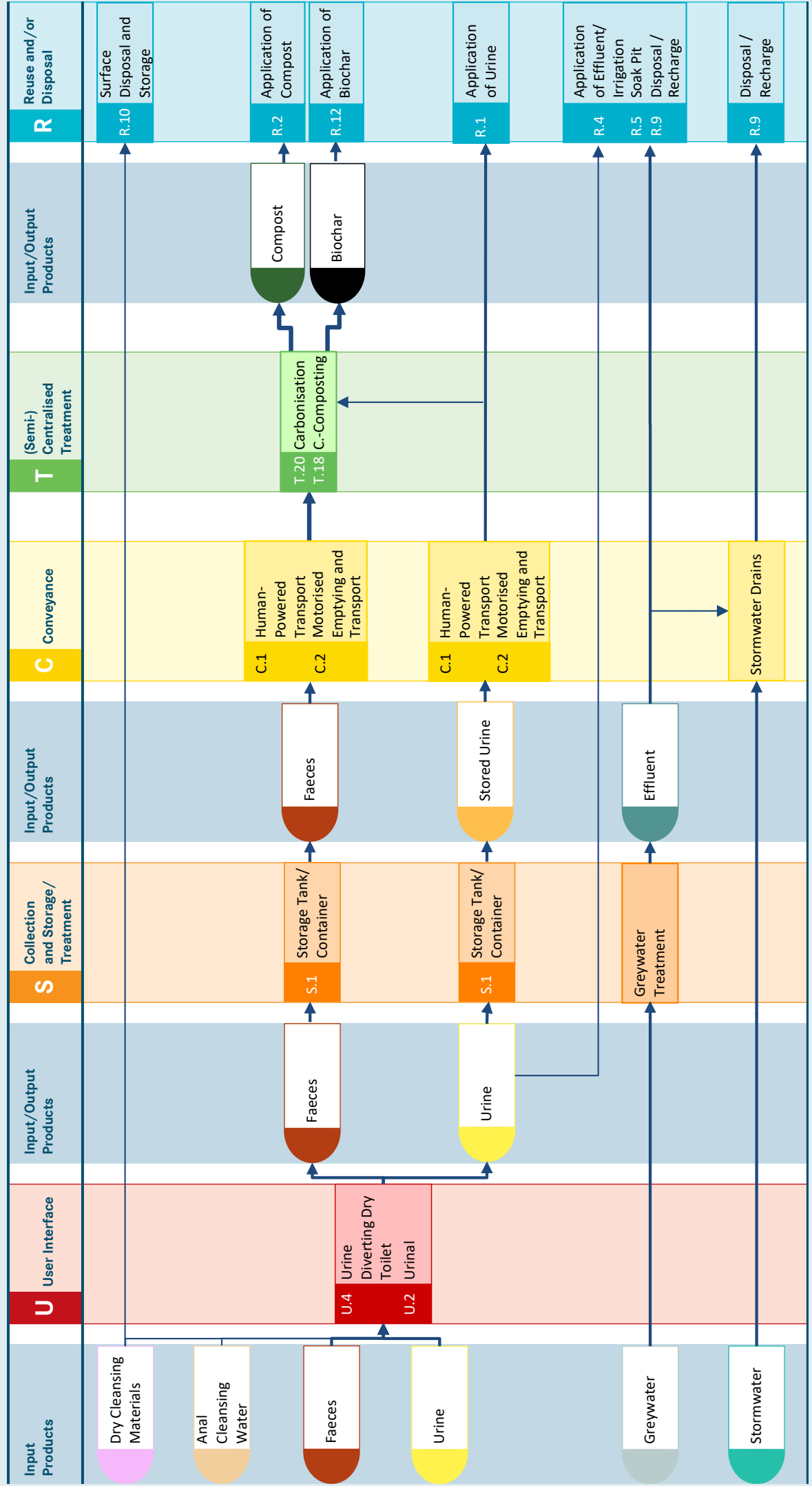

System 6: Container-based System with Urine Diversion and Transport to Off-site Treatment

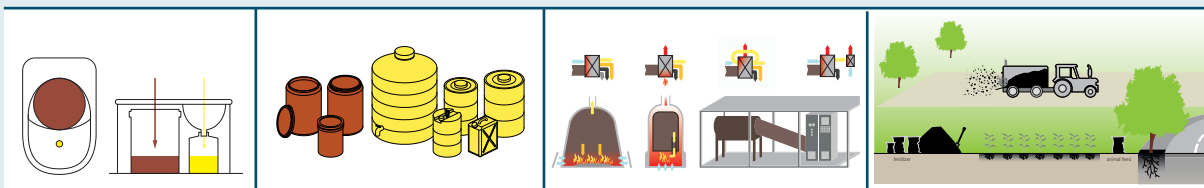

This system is designed to separate Urine and Faeces at the source (i.e. in the toilet) to allow for separate treatment and resource recovery for beneficial use. Inputs to the system can include Faeces, Urine, Anal Cleansing Water and Dry Cleansing Materials.

The User Interface technology for this system is the Urine-Diverting Dry Toilet (UDDT, U.4), which allows for Urine and Faeces to be separately collected. A Urinal (U.2) can additionally be installed for the effective collection of Urine. Different UDDT designs, as presented in the 2nd Edition of the Eawag Compendium, exist for different preferences and local conditions. This Compendium features a system based on the principles of Container-Based Sanitation (CBS), i.e. an end-to-end service in which toilets collect excreta in sealable, removable containers. CBS is the recommended solution where informal settlements are to be served by utilities. Without a robust collection, transport and treatment service, a CBS system cannot function.

After defecation, a constant supply of ash, lime, soil, or sawdust is important to cover the Faeces. This helps to absorb humidity, minimise odours and provide a barrier between the Faeces and potential vectors (flies). If ash or lime are used, the related pH increase will also help to kill pathogenic organisms. Flies and odour nuisance can be further reduced by equipping the UDDT with a vent pipe.

Faeces can be easily transported in sealed containers for further treatment, e.g. by Co-Composting (T.17) or Carbonisation (T.19). The corresponding treatment products (Compost, R.2 or Biochar, R.12) are either transported in bulk for nearby agri- or horticultural application or packed in bags to ease transport and commercialisation. Additional technologies for processing the faeces to commercially viable products are presented in the above mentioned “Guide to Sanitation Resource Recovery”, such as: Vermicomposting and Vermifiltration or Black Soldier Fly Larvae Composting.

For the Collection and Storage/Treatment of Urine, jerrycans or other Storage Tank/Container (S.1) are used. Alternatively, Urine can also be directly infiltrated through a Soak Pit (R.5) or be reused on-site,

e.g. fertilising home gardens (R.1).

Stored Urine poses little risk because it is nearly sterile. With its high nutrient content, it can be used as a good liquid fertiliser, after proper dilution. Stored Urine can be transported for Application in agriculture (R.1) using Human-Powered and/or a Motorised Emptying and Transport technology (C.1 and C.2). Technologies for further processing and commercialising of urine as concentrated liquid or crystalline fertiliser are presented in the “Guide to Sanitation Resource Recovery” introduced on p. 76ff: Nitrification and Distillation of Urine, Struvite Precipitation and Alkaline Dehydration of Urine.

Considerations This system can be used anywhere, but is appropriate for areas with temporary or informal housing structures/situations, high population density with no option for onsite Collection and Storage/Treatment, especially where access with vehicles access is limited, in rocky areas where digging is difficult, where there is a high groundwater table or in water-scarce regions. It can also be used for large events, such as festivals. The success of this system depends on the efficient separation of Urine and Faeces, as well as the use of a suitable cover material. A dry, hot climate can also considerably contribute to the rapid dehydration of the Faeces. In CBS systems, the faecal material is transported in a safe way in sealed containers with the use of personal protective equipment. Greywater is not handled in this system and requires a separate solution.

All types of Dry Cleansing Materials can be used, although it is best to separately collect them as they will use up space in the containers and may not degrade as fast as faeces in processes, such as Co-Composting (T.17).

Part 2: Functional Groups with Technology Information

The second part of the Compendium provides an overview of the different sanitation technologies within each functional group by explaining how they work, where they can be used and their advantages and disadvantages.

For each technology described in the system templates, there is a **technology information sheet** that includes an illustration, a summary of the technology and a discussion of its appropriate applications and limitations. An explanation of how to read the technology information sheets is given on the following two pages.

The double-page description of the technologies is not intended to be a design manual or technical reference; rather, it is meant to be a starting point for further detailed design. Moreover, the technology descriptions are to serve as a source of inspiration and discussion amongst engineers and planners who may not have previously considered all of the feasible options.

The technologies are arranged and colour-coded according to the associated functional group:

U **User Interface** (Technologies U.1-U.4): Red

S **Collection and Storage/Treatment**
(Technologies S.1-S.6): Orange

C **Conveyance** (Technologies C.1-C.5): Yellow

T **(Semi-) Centralised Treatment**
(Technologies PRE, T.1-T.19, POST): Green

R **Reuse and/or Disposal**
(Technologies R.1-R.12): Blue

Each technology within a given functional group is assigned a reference code with a single letter and number; the letter corresponds to the functional group (e.g. U for User Interface) and the number, going from lowest to highest, indicates approximately how resource intensive (i.e. economic, material and human) the technology is compared to the other technologies within the group.

The closing section presents Emerging Technologies, which although still under development and being tested, show great promise for future application.

Reading the Technology Information Sheets

The following Figures are examples of the heading of technology information sheets.

T.8		Horizontal Flow Wetland		Applicable to: Systems 1-5
Application Level:		Management Level:		Inputs:
<input type="checkbox"/> * Household <input type="checkbox"/> ** Neighbourhood <input type="checkbox"/> * City		<input type="checkbox"/> * Household <input type="checkbox"/> ** Shared <input type="checkbox"/> ** Public		<input type="checkbox"/> Effluent <input type="checkbox"/> Wastewater <input type="checkbox"/> Blackwater <input type="checkbox"/> Brownwater <input type="checkbox"/> Greywater
				Outputs:
				<input type="checkbox"/> Effluent <input type="checkbox"/> Biomass

U.1		Cistern Flush Toilet		Applicable to: Systems 1-4
Application Level:		Complexity Level:		Inputs:
<input type="checkbox"/> * Household <input type="checkbox"/> ** City		Low - medium - high		<input type="checkbox"/> Faeces <input type="checkbox"/> Urine <input type="checkbox"/> Flushwater <input type="checkbox"/> Anal Cleansing Water <input type="checkbox"/> Dry Cleansing Materials
				Outputs:
				<input type="checkbox"/> Blackwater

1 The title with colour, letter and number code.

The colour code (green) and the letter (T) indicate that the technology belongs to the functional group (Semi) Centralised Treatment (T). The number (8) indicates that it is the eighth technology within the functional group. Each technology description page has a similar colour, letter and number code, allowing for easy access and cross-referencing.

2 Applicable to Systems 1-5 or 1-4.

This indicates in which system template the technology can be found. In this case, e.g., the Horizontal Flow Wetland can be found in the Systems 1 to 5. Other technologies may be applicable to one system only.

3 Application Level.

Three spatial levels are defined under this heading:

- *Household* implies that the technology is appropriate for one or several households.
- *Neighbourhood* means that the technology is appropriate for anywhere between several and several hundred households.
- *City* implies that the technology is appropriate at the city-wide level (either one unit for the whole city, or many units for different parts of the city).

Stars are used to indicate how appropriate each level is for the given technology:

- *two stars* means suitable,
- *one star* means less suitable and
- *no star* means not suitable.

It is up to the Compendium user to decide on the appropriate level for the specific situation that he/she is working on. The Application Level graphic is only meant to be a rough guide to be used in the preliminary planning stage. The technologies within the functional group User Interface for the first time include an Application Level - with only two different categories:

- *Private household & office buildings* means that the technology will be functioning under better surveillance and maintenance, as compared to public or shared facilities
- *Public & shared facilities* implies that the technology is robust enough to be functioning in non-private circumstances with less surveillance.

4 Management Level describes the organisational style best used for the operation and maintenance (O&M) of the given technology:

- *Household* implies that the household, e.g. the family, is responsible for all O&M.
- *Shared* means that a group of users (e.g. at a school, a community-based organisation, or market vendors) handles the O&M by ensuring that a person or a committee is responsible for it on behalf of all users. Shared facilities are defined by the fact that the community of users decides who is allowed to use the facility and what their responsibilities are; it is a self-defined group of users.
- *Public* implies institutional or government run facilities and all O&M is assumed by the agency operating the facility. Usually, only users who can pay for the service are permitted to use public facilities.

The Horizontal Flow Wetland in this example can be managed by all three styles, even though it is less suitable for private households.

The technologies in the functional group User Interface include a Complexity Level instead of a Management Level. The maintenance of User Interface is dependent on the subsequent technologies.

5 Complexity level is a new category, specifically for the functional group User Interface. It describes how difficult or complex it may be for the owner and operator of a given technology to ensure its sustainable functionality.

- *Low* implies that no specific skills or capacities are required to observe, analyse and select the right measure to maintain the functionality of a given technology functional
- *Medium* means that medium level skills and capacities (including access to equipment and spare parts) are required to observe, analyse and select the right measure to keep a given technology functional
- *High* implies that advanced and professional skills and capacities (including access to equipment and spare parts) are required to observe, analyse and select the right measure to keep a given technology functional

6 Inputs refers to the products that flow into the given technology. The icons shown **without parentheses** are the regular inputs that will typically go into a technology. For some technologies, these products represent alternatives or options (possibilities) of which not all are necessary. Hence, the regular icons represent the mandatory products or choice of mandatory main products.

Products **in parentheses ()** are additional (optional) products that may or may not be used or occur as input products, depending on the design or context.

Where a product occurs mixed with another product, this is indicated by the plus +. The product following the + is mixed with the preceding product(s). In other words: both of the products on either side of the + are included in the given technology and are mixed together.

In the second example, Urine and Faeces are the main input products processed by the Cistern Flush Toilet. Dry Cleansing Materials may also be included, but if in parentheses, this indicates that it is an additional, optional input in case the users are wipers and the materials biodegradable. Anal Cleansing Water in some user interfaces may be input and/or output, depending on regional or local practice.

7 Outputs refer to the products that flow out of the given technology. The icons shown **without parentheses** are the regular outputs that typically come out of a technology. Products in parentheses () are additional (optional) products that may or may not occur as output products, depending on the design or context.

When these products occur mixed with another product, this is indicated by a **plus +**. The product following the + is mixed with the preceding product(s). In other words: both of the products on either side of the + emanate from the given technology in a mixed form (e.g. U.4 on p 46).

8 NBS refers to **Nature Based Solutions**, according to Figure 1 on p. 169.

This section describes the technologies with which the user interacts, i.e. the type of toilet, pedestal, pan, or urinal used by the user. The User Interface must guarantee that human excreta is hygienically separated from human contact to prevent exposure to faecal contamination. There are two main types of interfaces: dry technologies that operate without water (U.4) and water-based technologies that need a regular supply of water to function properly (U.1, U.3). Urinals (U.2) can function both as a dry- or water-based technology. Different User Interface technologies generate different output products. This influences the subsequent type of Collection and Storage/Treatment or Conveyance technology.

- U.1 Cistern Flush Toilet
- U.2 Urinal
- U.3 Urine-Diverting Flush Toilet (UDFT)
- U.4 Urine-Diverting Dry Toilet (UDDT)

In any given context, the technology choice generally depends on the following factors:

- Availability of water for flushing
- Housing conditions (e.g. land tenure and availability)
- Compatibility with options for subsequent Collection and Storage/Treatment or Conveyance technology
- Habits and preferences of the users (sitting or squatting, washing or wiping)
- Special needs of user groups
- Local availability of materials
- Availability of appropriate services (e.g. CBS service)



Application Level:

(**) Household

(*) City

Complexity Level:

Low - medium - high

Inputs:

Faeces Urine Flushwater

Anal Cleansing Water

Dry Cleansing Materials

Outputs:

Blackwater

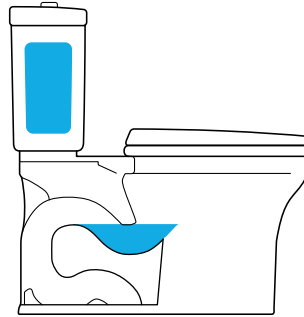
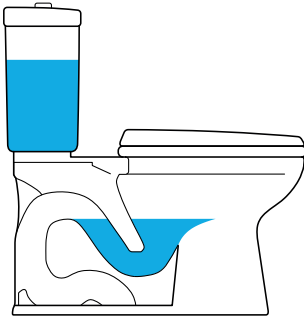
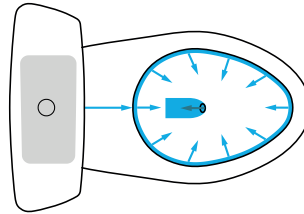
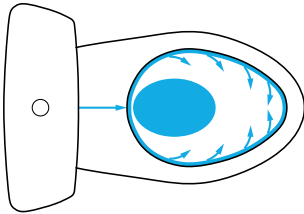

Flush toilet

Pressure-assist toilet

The most common User Interface in the urban environment of the Caribbean is the Cistern Flush Toilet. It consists of a bowl to sit on and a water tank providing the water for flushing the excreta. The toilets are usually made of porcelain, but plastic is also used. Simple Cistern Flush Toilets have a low degree of complexity and are available everywhere locally.

Water that is stored in the cistern above the toilet bowl is released by pushing a button or pulling a lever. This allows the water to run into the bowl, mix with the excreta and flush them down the drain pipes. The inner piping of the toilet forms a syphon to create a water seal that prevents odours from the drain pipe system coming back up.

Design Considerations Simple flush toilets (above on the left) use about 6 to 9 L (≥ 1.6 US gal) per flush, whereas older models were designed for flush-water quantities up to 20 L. Low-flow or low-flush toilets are designed with a special cistern and syphon system to consume less than 5 L (≤ 1.28 gal) per Flush. They usually have a dual flush system, where one flush

is designed for urine only and uses less water than the other for faeces. The latter have a medium level of complexity. However, simpler designs of low-flush toilets do not always manage to completely remove all excreta with one flush. Consequently, the user has to flush two or more times to adequately clean the bowl, which negates the intended saving of water.

Pressure-assist toilets are designed to increase cleaning performance with even less water. Water consumption per flush can be less than 5 L (≥ 3.8 L or 1 gal), depending on the model (ToiletReviewer.com, 2020). A special pressure cartridge inside the water tank uses the water pressure to collect air (with pressure of around 35 psi or more). This air increases the flushing pressure when released during flushing, forcing the water to move faster through the bowl. The special design of the bowl and the release of some of the water directly into the bottom channel creates a suction force that breaks up solids and carries them through the syphon. However, the complexity is high, repair requires expertise and the price of such toilets can be several times the price of a simple cistern flush toilet.

Appropriateness A Cistern Flush Toilet requires both a constant source of water for flushing (daily about 12 - 28 L per person) and a Collection and Storage/Treatment or Conveyance technology to receive the blackwater. Considering the high price of water in parts of the Caribbean, low-flush toilets are recommended for private and public applications. For public facilities, particularly robust materials may be considered in exchange for porcelain.

Health Aspects/Acceptance It is a safe and comfortable toilet, well known and accepted in the region. With proper use and regular cleaning, Cistern Flush Toilets do not pose any health risks.

Operation & Maintenance The toilet should be regularly scrubbed clean to maintain hygiene and prevent the buildup of stains. It is necessary to observe and regularly change seals in order to avoid a constant flow of water from the tank into the bowl. Further maintenance is required, such as replacing or repairing some mechanical parts or fittings. For some on-site treatment systems, it is recommended not to throw cleansing materials, such as toilet paper into the bowl, but to

collect them in a separate bin. Menstrual hygiene products and other commonly used products, such as wet wipes, should never be put into a Cistern Flush Toilet.

Pros & Cons

- + Excreta are directly flushed away and transported to the Storage/Treatment or Conveyance system
- + Proper use and regular cleaning provide hygienic conditions with no health risks
- + No real problems with odours if used correctly
- + Suitable for all types of users (wipers and washers)
- High capital costs especially for advanced low-flush toilet systems; spare parts may be unavailable
- Pressure-assist toilets are noisier, need a certain water pressure in the water supply system and manufacturing defects can cause the tank to burst
- Operating costs depend on the price of water, but water savings are possible
- Requires a constant source of water and a volume between 12-28 L per person/day

References & Further Reading

can be found on page 238

Application Level:

- (**) Private household & office buildings
- (**) Public & shared facilities

Complexity Level:

Low - medium

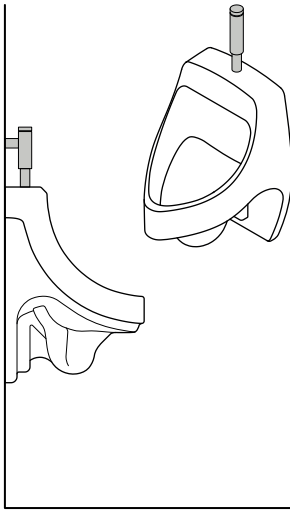
Inputs:  Urine  Flushwater**Outputs:**  Urine +  Flushwater

Flush urinal

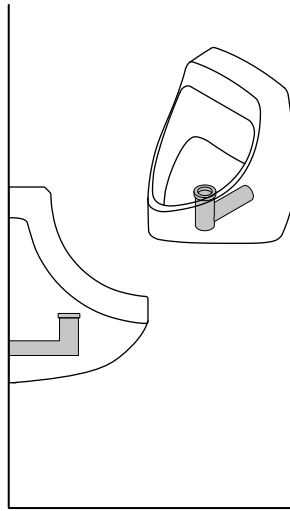

Waterless urinal

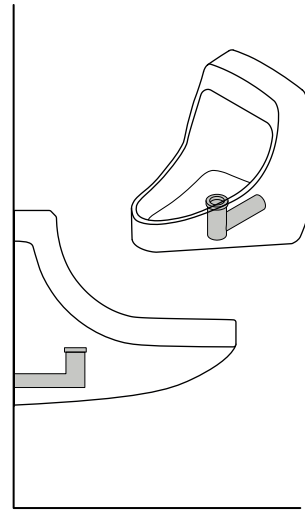

Female urinal

A Urinal is used only for collecting urine. Urinals are generally for men, although models for women have also been developed. Most urinals use water for flushing, but waterless urinals are becoming increasingly popular.

Urinals for men in the region are usually vertical wall-mounted units. Urinals for women are still rare and usually wall-mounted units. They consist of a sloped channel or catchment area that conducts the urine to a special plumbing system.

The urinal can be used with or without water and the plumbing can be developed accordingly. If water is used, it is mainly used for cleaning and limiting odours (with a water-seal). In some public applications, urinals with regular automatic flushing are installed or photocells are used to start automatic flushing after each use.

Urinals can discharge into a mixed plumbing system that also captures blackwater or the urine can be collected separately.

Design Considerations For water-based urinals, the water use per flush ranges from less than 2L in current designs to several litres of flushwater in outdated models. Water-saving or waterless technologies should be favoured. To minimise odours and nitrogen loss in simple waterless urinal designs, the collection pipe should be submerged in the urine tank to provide a basic liquid seal.

Waterless urinals are available in a range of styles and complexities. Urinals equipped with an odour seal are recommended. There are various types of odour seals. For example, the seal can consist of two rubber or silicon tabs that open and let the liquid through and then close again or a syphon containing a barrier liquid that is lighter than urine and, therefore, serves as a liquid seal. Waterless urinals need expertise for maintenance and repair.

By putting a small target, or painted fly near the drain, the amount of spraying or splashing can be reduced; this type of user-guidance can help improve the cleanliness of the facility. Because the urinal is exclusively for urine, in public applications it is important to provide a toilet as well to be used for faeces.

Appropriateness Urinals can also be used in homes to facilitate the urine separation. However, they are mostly installed in public facilities. In some cases, the provision of a urinal is useful to prevent the misuse of dry systems (e.g. UDDT, U.4). Portable waterless urinals have been developed for use at large festivals, concerts and other gatherings, to improve the sanitation facilities and reduce the point load of wastewater discharged at the site. In this way, a large volume of urine can be collected (and either used or discharged at a more appropriate location or time) and the remaining toilets can be reduced in number or used more efficiently.

Health Aspects/Acceptance The urinal is a comfortable and easily accepted user interface. Although simple in construction and design, urinals can have a large impact on the well-being of a community. When men have access to a urinal, they may urinate less often in public, which reduces unwanted odours and makes everyone feel more comfortable. Men have generally accepted waterless urinals, as they do not call for any change of behaviour.

Operation & Maintenance Maintenance is simple, but should be done frequently, especially for waterless urinals. All of the surfaces should be cleaned regularly (bowl, slab and wall) to prevent odours and to minimise the formation of stains. Particularly, in waterless urinals, calcium- and magnesium-based minerals and salts can precipitate

and build up in pipes and on surfaces where urine is constantly present. Washing the bowl with a mild acid (e.g. vinegar) and/or hot water can prevent the build-up of mineral deposits and scaling. Stronger (> 24% acetic) acid or a caustic soda solution (2 parts water to 1 part soda) can be used for removing blockages. However, in some cases, manual removal may be required. For waterless urinals, it is critical to regularly check the functioning of the odour seal. Depending on the selected technology, specific controls and spare parts may be required. Therefore, the Complexity Level is low to medium.

Pros & Cons

- + Waterless urinals do not require a constant source of water
- + Can be built and repaired with locally available materials
- + Low capital and operating costs
- Problems with odours may occur if not used and maintained correctly
- Women's urinal technology is still not widely accepted and there are still behavioural barriers against its use.
- Models for women are not widely available

References & Further Reading

can be found on page 239

Application Level:

- (**) Private household & office buildings
- (*) Public & shared facilities

Complexity Level:

Medium - high

Inputs:

- Faeces
- Urine
- Flushwater
- Anal Cleansing Water
- Dry Cleansing Materials

Outputs:

- Blackwater
- Urine

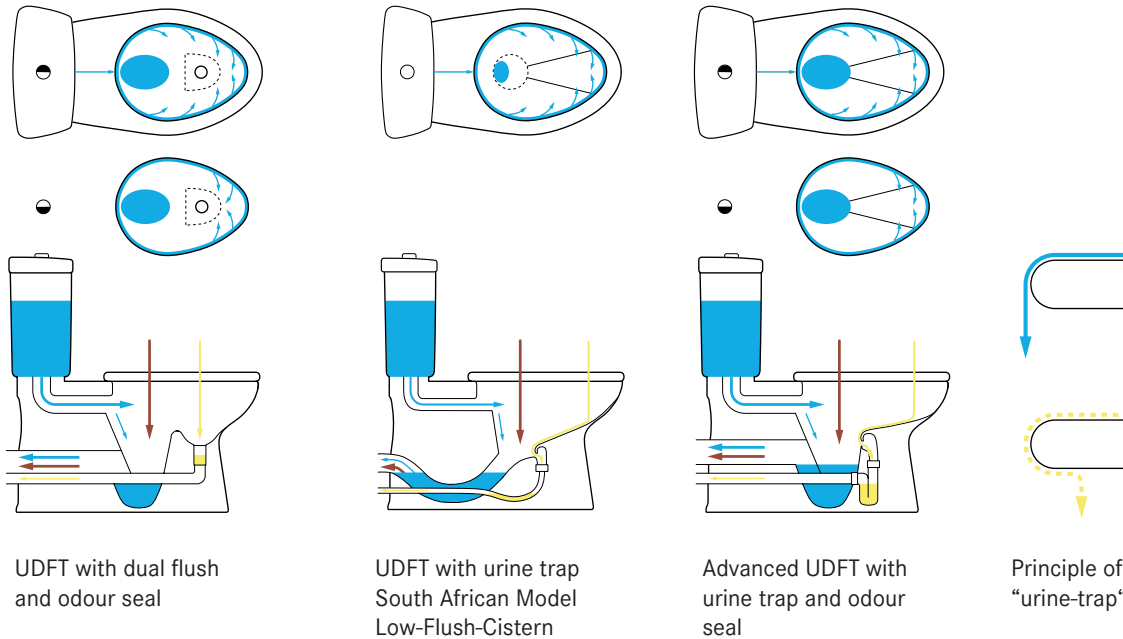

Urine-Diverting Flush Toilets (UDFT) are similar in their appearance to Cistern Flush Toilets (U.1). A special design of the bowl allows for the diversion of urine into a separate drain pipe system.

Urine contains most of the nutrients in human excreta and is usually pathogen-free (exception: urinary infection). The separation of urine from faeces and flush water directly at the user interface, therefore, saves energy-intensive, complex and costly processes of nutrient elimination or recovery during wastewater treatment.

Design Considerations The system requires a dual plumbing system, i.e. separate piping for urine and brownwater (faeces, dry cleansing material and flushwater). The separation of urine from the blackwater can be achieved through different types of designs.

The traditional UDFT bowl design (Dubletten and Westman in Mitchell, 2013) has a separate section for urine collection. Urine is collected in this section in the front of the toilet and faeces are collected in the back. A small amount of water is used to rinse the urine-collection

bowl when the toilet is flushed ($\cong 0.3$ L or 0.08 gal). The urine flows via a urine piping system into a storage tank for use or further processing. The faeces are flushed with water ($\cong 2.5$ L or 0.66 gal) into the drain pipe. Two separate buttons are installed at the water tank to allow for the different water flushes (see above left).

A completely different design has emerged, which performs reliable urine diversion with a design close to the traditional flush toilet, i.e. without a visible urine section in the front of the bowl. This "urine trap" design (EOOS, 2018, above right) allows for full flushing of the bowl, including the urine-collection part, using the hydrodynamic principle of the "teapot effect" to conduct the urine towards a concealed outlet based on surface adhesion. The urine, flowing at a low speed and rate, diverts into an opening below the upper part of the bowl. Flushing water with a much higher rate and speed runs down into the lower part of the bowl and from there through the odour seal into the toilet drain. Advanced UDFT designs include an odour seal in the urine conduit. The urine then flows through a separate plumbing system into a storage tank for further use or processing onsite or transported to special semi-central treatment or reuse sites.

Next to the Urine-Diverting Cistern Flush Toilet, there are also Urine-Diverting Pour Flush Toilets, which can be operated manually or with a 2 L cistern flush (see p. 154). Plastic pipes should be used for the urine discharge with a minimum diameter of 2" to avoid corrosion and clogging. The piping system to storage tanks should be kept as short as possible and should be installed with at least a 1% slope. A piping system with possible access points and without sharp angles (90°) allows for easy maintenance. Larger diameter pipes (> 3") should be used where access is difficult.

Appropriateness A UDFT is adequate when there is enough water for flushing, a treatment technology for the brownwater and a use for the collected urine. UDFTs are suitable for public and private applications. When used in public toilets, the installation of Urinals (U.2) for men is recommended to improve diversion efficiency. Since this technology requires separate pipes for urine collection and brownwater flow, the plumbing is more complex than for cistern flush toilets. The proper design and installation of the urine pipes are crucial and require expertise.

Health Aspects/Acceptance Like the cistern flush toilet, the UDFT technology is a user interface that does not pose any health risk if properly used and regularly cleaned. Complaints about odour nuisance can be avoided by regularly cleaning and the installation of a urine odour seal in the piping. A traditional UDFT requires user training and advice for proper use. When children use this type of toilet, faeces can fall into the urine section and the urine can become contaminated with pathogens. Detailed research on social acceptance amongst users has been carried out in Sydney, Australia (see Annex, also covering installation, reuse and regulation).

UDFTs, following the "urine trap" design do not require special advice for proper use and acceptance – they can be used by men, women and children in the same way as common cistern flush toilets.

Operation & Maintenance As with any toilet, proper cleaning is important to maintain hygiene and prevent stains from forming. Because urine is collected separately, calcium- and magnesium-based minerals and salts can precipitate and build up in the fittings and pipes. Washing the bowl with a mild acid (e.g. vinegar) and/or hot water can prevent the build-up of mineral deposits. Installing access points in the urine piping system allows for easier cleaning and removing blockages when required. The regular and reliable emptying of the urine storage tanks and its subsequent processing is essential for the sustainable functionality of this technology. UDFTs with an odour seal have a medium to high complexity level and expertise is required for installation, repair and maintenance.

Pros & Cons

- + UDFT with "urine trap" design can be used by men, women and children, such as any Cistern Flush Toilet, making it a truly aspirational product
- + Requires less water than conventional Cistern Flush Toilets
- + No real problems with odours if an odour seal is installed and used correctly
- + Separation of urine simplifies and lowers the cost of wastewater treatment (coping with discharge standards for nutrient removal)
- + Global Access policy for "urine trap" technology allows for the licence free production in certain regions (including most parts of WCR) and the replication of low-cost production from plastics
- Limited availability
- Labour-intensive maintenance, including the urine storage tanks
- Designs without "urine trap" are prone to misuse and clogging
- Requires a constant source of water

References & Further Reading

can be found on page 239

Application Level:

(**) Private household

Complexity Level:

Low

Inputs: Faeces Urine

(Anal Cleansing Water) (Dry Cleansing Materials)

Outputs: Faeces (+ Dry Cleansing Materials)

Urine (Anal Cleansing Water)

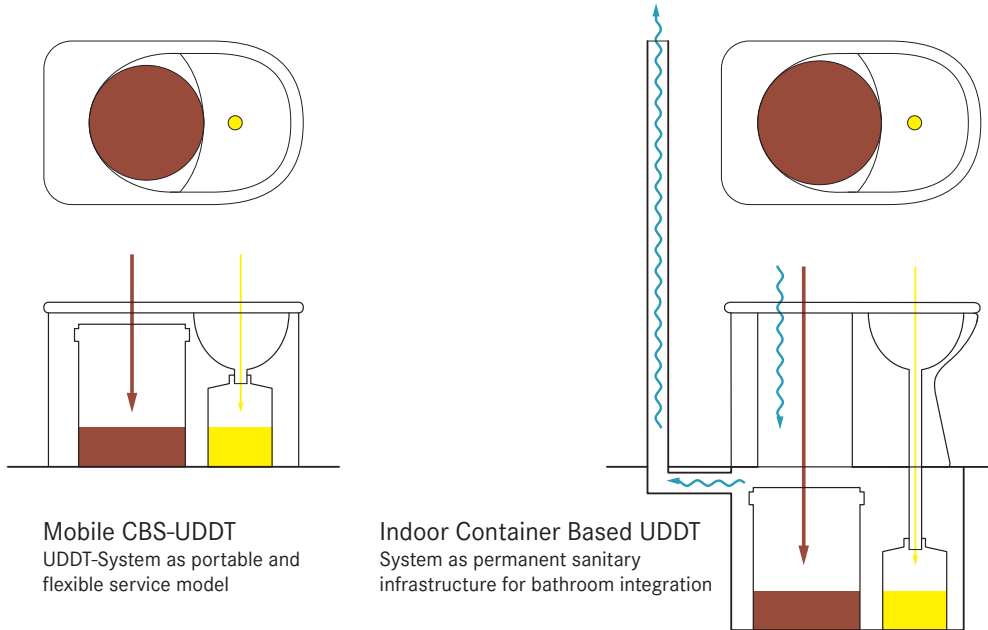

Mobile CBS-UDDT
UDDT-System as portable and
flexible service model

Indoor Container Based UDDT
System as permanent sanitary
infrastructure for bathroom integration

A Urine-Diverting Dry Toilet (UDDT) is a toilet that operates without water and has a divider so that the user, with little effort, can divert the urine away from the faeces.

The UDDT is built such that urine is collected and drained from the front area of the toilet, while faeces fall through a large chute (hole) in the back. A small amount of drying material, such as lime, ash, sawdust, earth or carbon rich organic material, should be added into the same hole after defecating. Many dry toilets (with or without urine diversion) can be found in densely populated, often informal urban and periurban settlements. Generally, the Collection and Storage/Treatment technology that follows is a simple pit. Because these systems are difficult to service and tend not to be lined, they are not a good choice for areas served by a utility. Therefore, this Compendium is featuring UDDT's designed as a "Container Based Sanitation" system (CBS), i.e. an end-to-end service that hygienically collects urine and faeces from toilets built with sealable, removable containers and that strive to ensure that the products are treated safely and reused as much as possible. Accordingly, beyond explaining the

UDDT, this technology sheet features the integration of two functional groups: the User Interface [U] and the Collection and Storage [S].

Design Considerations It is important that the two sections of the toilet are well separated to ensure that a) faeces do not fall into and clog the urine collection area in the front and that b) urine does not splash down into the dry area of the toilet. Over the past decades, a number of Container Based UDDT systems have been developed and evaluated that fulfil these requirements. Three of the manufacturers/service providers are operating in Latin America and the Caribbean (see references below).

Where UDDTs shall be constructed as permanent structures, the following design considerations are of importance: urine tends to rust most metals; therefore, metals should be avoided in the construction and piping of the UDDT. To limit scaling, all connections (pipes) to storage tanks should be kept as short as possible; whenever they exist, pipes should be installed with at least a 1% slope and sharp angles (90°) should be avoided. A pipe diameter of 2" is sufficient for steep slopes and where maintenance is easy. Larger diameter

pipes (> 3”) should be used elsewhere, especially for minimum slopes and where access is difficult. To prevent odours from coming back up the pipe, an odour seal should be installed at the urine drain. If possible a ventilation pipe should be considered in the design, as this helps to reduce odour and fly nuisance. Additional convenience can be achieved by mechanisms or features on the toilet that allow for covering the faeces container when not needed.

Appropriateness The UDDT is simple to design and build, using such materials as concrete and wire mesh or plastic. The UDDT design can be altered to suit the needs of specific populations (i.e. smaller for children, people who prefer to squat, etc.). The UDDT has a low complexity level and is easy to maintain and repair.

Health Aspects/Acceptance The UDDT is not intuitive or immediately obvious to some users. At first, users may be hesitant about using it and mistakes made (e.g. faeces in the urine bowl) may deter others from accepting this type of toilet as well. Demonstration projects and training are essential to achieve good acceptance with users. For better acceptance of the system and to avoid urine in the faeces collection bowl, the toilet can be combined with a Urinal (U.2), allowing men to stand and urinate.

Operation & Maintenance A UDDT is slightly more difficult to keep clean compared to other toilets because of both the lack of water and the need to separate the solid faeces and liquid urine. No design will work for everyone and, therefore, some users may have difficulty separating both streams perfectly, which may result in extra cleaning and maintenance. Faeces can be accidentally deposited in the urine section, causing blockages and cleaning problems.

All of the surfaces should be cleaned regularly to prevent odours and to minimise the formation of stains. Water should not be poured in the toilet for cleaning. Instead, a damp cloth may be used to wipe down the seat and the inner bowls. Some toilets are easily removable and can be cleaned more thoroughly. It is important that the faeces remain separate and dry. When the toilet is

cleaned with water, care should be taken to ensure that the faeces are not mixed with water.

Because urine is collected separately, calcium- and magnesium-based minerals and salts can precipitate and build up in pipes and on surfaces where urine is constantly present. Washing the bowl with a mild acid (e.g. vinegar) and/or hot water can prevent the build-up of mineral deposits and scaling. Stronger (> 24% acetic) acid or a caustic soda solution (2 parts water to 1 part soda) can be used for removing blockages. However, in some cases, manual removal may be required. An odour seal also requires occasional maintenance. It is critical to regularly check its functioning.

Pros & Cons

- + Does not require a constant source of water
- + No real problems with flies or odours if used and maintained correctly
- + Can be built and repaired with locally available materials
- + Low capital and operating costs
- + Suitable for all types of users (sitters, squatters, washers, or wipers)
- Prefabricated models not available everywhere
- Requires training and acceptance to be used correctly
- Is prone to misuse and clogging with faeces
- The excreta pile is visible
- Men usually require a separate Urinal for optimum collection of urine

References & Further Reading

can be found on page 240











This section describes the technologies that collect and store the products generated at the User Interface. Some of the technologies presented here are specifically designed for treatment, while others are specifically designed for collection and storage. The latter also provide some degree of treatment, depending on the storage time and conditions. The treatment provided by S technologies is usually passive (e.g. requiring no energy input). Because of the storage period implicit in the design of these technologies, there is a reduced threat of contamination.

- S.1 Storage Tank/Container
- S.2 Holding Tank
- S.3 Septic Tank
- S.4 Anaerobic Baffled Reactor (ABR)
- S.5 Anaerobic Filter
- S.6 Submerged Aerated Fix Filter (SAFF)

In any given context, the technology choice generally depends on the following factors:

- Availability of space
- Soil and groundwater characteristics
- Type and quantity of input products
- Local availability of materials
- Desired output products
- Availability of technologies for subsequent transport
- Financial resources
- Management considerations
- User preferences



Application Level:	Management Level:	Inputs:  Urine  Faeces
 Household	 Household	Outputs:  Urine  Stored Urine  Faeces
 Neighbourhood	 Shared	
 City	 Public	

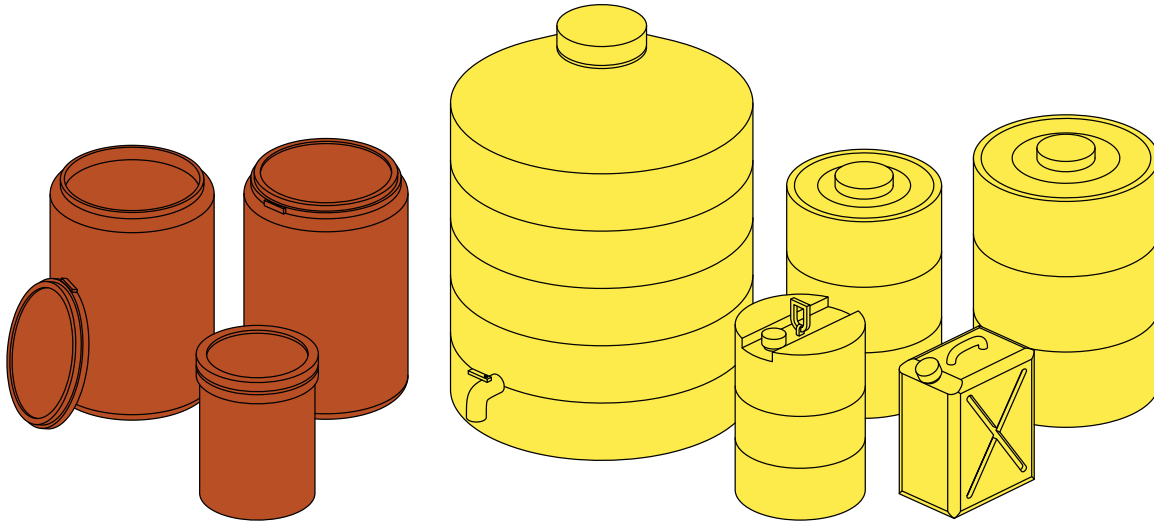

Plastic containers can be used for storage and transport of urine and faeces. Urine can be stored on-site in jerrycans, sealable containers or tanks (yellow colour). Containers for faeces (brown colour) may be plastic barrels, simple buckets or specially designed containers that fit into the designed space of the user interface (UDDTs).

Storage tanks and containers can be used to store urine to stabilise it and allow for its safer use. Urine contains a high proportion of urea, which is rapidly converted to ammonia during storage, a reaction catalysed by the enzyme urease. Ammonia has a strong odour, so urine stored in tanks or containers that are not completely sealed would be a strong odour nuisance. Many urine treatment technologies inhibit this reaction and convert the urine into a concentrated, more stable liquid or a crystalline fertiliser. (“Guide to Sanitation Resource Recovery”, p. 76ff: Nitrification and Distillation, Struvite Precipitation and Alkaline Dehydration of Urine).

Containers for faeces are used for transport from the customer of a CBS system to the treatment plant. Longer storage times should be avoided to prevent pos-

sible biogas production if the moisture in the container allows for anaerobic decomposition.

Design Considerations The size of the urine storage tank should be appropriate for the number of users and the time needed to sanitise the urine. It is generally accepted that urine is safe for household agricultural application, if it is stored for at least one month. If the urine is used for crops that will be eaten by people other than the urine producer, it should be stored for six months beforehand (see the WHO Guidelines, 2006, for specific recommendations on storage and application). On average, a person generates about 1.2 L of urine per day; however, this quantity may vary significantly depending on the climate and fluid consumption. The tanks can be made of plastic (e.g. High-Density Polyethylene, HDPE) or fibreglass and should have a sealable opening at the top and may have an outlet with a tap at the bottom part. Permanent storage tanks can also be made of concrete. Metal should be avoided as it can easily be corroded by the high pH of stored urine.

Neither the storage tank, nor the collection pipes should be ventilated to avoid odour emissions from ammonia, but both must be pressure balanced. If the storage

tank is directly connected to the toilet or urinal, care should be taken to minimise the length of the pipe since precipitates will accumulate.

In CBS systems, the faeces' containers are part of the user interface and their size depends on several factors: the size of the toilet and the number of people using it, and the frequency with which the toilet needs to be emptied, and how easy it is to detect its maximum capacity. The filled containers are sealed and then collected and transported to treatment facilities (C.1). On the way there, the faecal content might be emptied into larger containers, such as sealable barrels. All faeces' containers are made of plastic. Their opening should correspond to their diameter to facilitate emptying and cleaning. The sealing of the lid should be secure and allow for storage and transport without the risk of accidental opening during handling. These containers are usually only used for a short period of time to transport the faeces to the depot or final treatment facility before being cleaned and sanitised and returned to the customer.

Appropriateness Urine storage tanks are most appropriate where there is a need for agricultural fertiliser which can be supplied by the stored urine. If there is no such need, but a CBS system offers an appropriate sanitation solution, the urine must be disposed of properly.

Urine storage tanks can be installed indoors, outdoors, above ground and below ground depending on the climate, available space and soil conditions.

Containers for faeces are an essential component of Container Based Sanitation (CBS) and provide safe transportation to treatment facilities. They should also be sized so that the weight of the filled containers allows for proper and safe handling of the container.

Health Aspects/Acceptance Long-term storage is the best way to sanitise urine without the addition of chemicals or mechanical processes. The risk of disease transmission from stored urine is low. Extended storage with storage times greater than six months provides near complete sanitisation.

The use of personal protective equipment is mandatory for handling urine and faeces containers. Proper cleaning and sanitising of the containers are essential parts of the operation procedures.

Operation & Maintenance The urine tank can be emptied through the top opening or, if available, through the bottom tap. If the storage tank is emptied using a vacuum truck (see C.2), the inflow of air must be maintained at a sufficient rate to ensure that the tank does not implode due to the vacuum. A viscous sludge will accumulate on the bottom of the storage tank. If the storage tank is fully emptied, the sludge will usually be emptied along with the urine, but if not, it may require desludging. Mineral and salt build-up in the tank or in connecting pipes can be manually removed (sometimes with difficulty) or dissolved with a strong acid (24% acetic acid). Because urine is fluid and nearly sterile, urine containers are much easier to empty and clean than containers for faeces.

Filling and emptying of faeces' containers and their cleaning are critical moments in the service chain of CBS systems. Appropriate tools and emptying devices are necessary to avoid faecal spills and environmental pollution.

Most CBS operators prefer to disinfect their containers, rather than sterilise them. Technically, disinfection involves the removal of most pathogenic organisms. This is different from both cleaning, which usually removes visible contaminants and solids from surfaces; and sterilisation, which is an extremely high standard of decontamination that ensures all organisms have been killed or removed. Disinfection is an appropriate level of decontamination that meets both US EPA and WHO safety standards.

Pros & Cons

- + Containers are widely available and reusable
- + Capital costs are low
- + Low risk of pathogen transmission for urine storage container
- + Stored urine can be used as a fertiliser
- + Low operating costs, but cleaning of containers can be labour-intensive.
- Mild to strong odour when opening and emptying tank
- May require frequent emptying (depending on container or tank size)
- Possible environmental pollution when cleaning containers in unsuitable locations

References & Further Reading

can be found on page 240

Application Level:	Management Level:	Inputs: <input checked="" type="checkbox"/> Blackwater <input type="checkbox"/> Greywater
<input checked="" type="checkbox"/> Household	<input checked="" type="checkbox"/> Household	Outputs: <input type="checkbox"/> Wastewater including <input checked="" type="checkbox"/> Faecal Sludge
<input type="checkbox"/> Neighbourhood	<input checked="" type="checkbox"/> Shared	
<input type="checkbox"/> City	<input type="checkbox"/> Public	

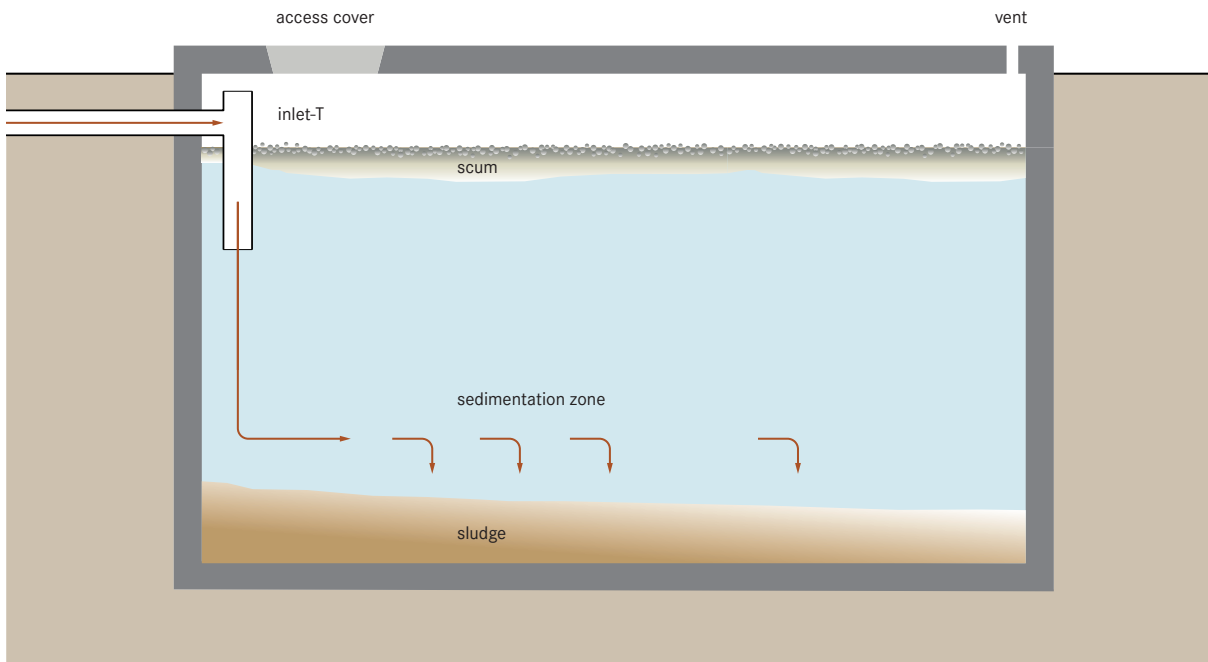

A Holding Tank is a watertight reservoir without any outlet, capable of storing the volume of wastewater generated in a household or institution over several days. A precondition for this technology is the availability of an emptying service.

A Holding Tank provides a means to collect and temporarily store wastewater for subsequent removal and transport to an approved treatment and reuse/disposal site. Holding Tanks do not perform any treatment to the wastewater. Where on-site use of the effluent is not possible or permitted and no sewer is available – even septic tanks operate as Holding Tanks, although their design allows for separation of the liquid and solid phases.

Design Considerations The Holding Tank system must be located in such a way as to facilitate pumping while limiting the general public exposure to sewage and to nuisance caused by spillage during pumping.

A Holding Tank must be designed, constructed and installed to ensure water tightness and should withstand anticipated stresses associated with internal and external loading, as well as the effects of contact with raw sewage.

The tank must be inherently non-buoyant so as to prevent floating when empty during high groundwater periods if such events are anticipated. A tank is non-buoyant if installed above the groundwater elevation, the weight of the empty tank exceeds buoyant forces, or “side wings” anchor the tank into surrounding soil.

Establishing the holding tank capacity requires consideration of both design and operational aspects. The required storage capacity depends upon two aspects: daily wastewater flow and available or optimal emptying service frequency. Water-saving devices, e.g. low-flush toilets or water-saving fittings, can extend the time intervals between emptying.

It is a good practice to install audible and visual alarms to prevent overflow. The alarms must be set to signal the “time-to-pump” and “exceeding reserve storage volume” levels. The audible and visual alarm signals must be located outside the facility, with battery power where electrical power is not available.

Appropriateness This technology is appropriate for places where there is no connection to a sewer system and effluent-producing on-site wastewater treatment technologies are not an option (e.g. no space available or

prohibition of infiltration due to groundwater protection). As for all spacious underground infrastructure, a rocky underground may also prevent choosing this technology. The temporary use of holding tanks can be found in places, such as construction sites or large festivals. It can also be implemented in emergency situations and used until a permanent conveyance and treatment system is put in place.

Health Aspects/Acceptance Under normal operating conditions, users do not come in contact with the wastewater, but there is a risk of operational or management problems, resulting in public exposure due to occasional overflowing of the tank. For this reason, the use of a holding tank must be closely regulated by local or national agencies.

Operation & Maintenance The system requires a Motorised Emptying and Transport (C.2) service and the off-site treatment and disposal of the wastewater generated on-site. To assure that the emptying can be performed efficiently, the system must be designed, installed and maintained in such a way that promotes ease of access and cleaning of the premises after each emptying service.

Depending upon the facility served or the particular set of circumstances surrounding the use of a holding tank, the operational cost for motorised emptying, transport and disposal at an approved facility can be very high, especially on a long-term basis.

Settling and floatation of solids may occur during storage. However, all material in the holding tank is removed during pumping.

Pros & Cons

- + Simple system for places where no on-site wastewater treatment is viable or where water cannot be infiltrated or collected by a sewer system
- + Small land area required (most of the structure can be built underground)
- + No electrical energy required
- + Long service life
- + May incentivise users to save water
- Due to regular emptying and transport of wastewater, operational cost are high
- Requires reliable tank level monitoring mechanism

References & Further Reading

can be found on page 240

Application Level:

- Household
- Neighbourhood
- City

Management Level:

- Household
- Shared
- Public

Inputs: Blackwater Brownwater
 Greywater

Outputs: Effluent Sludge

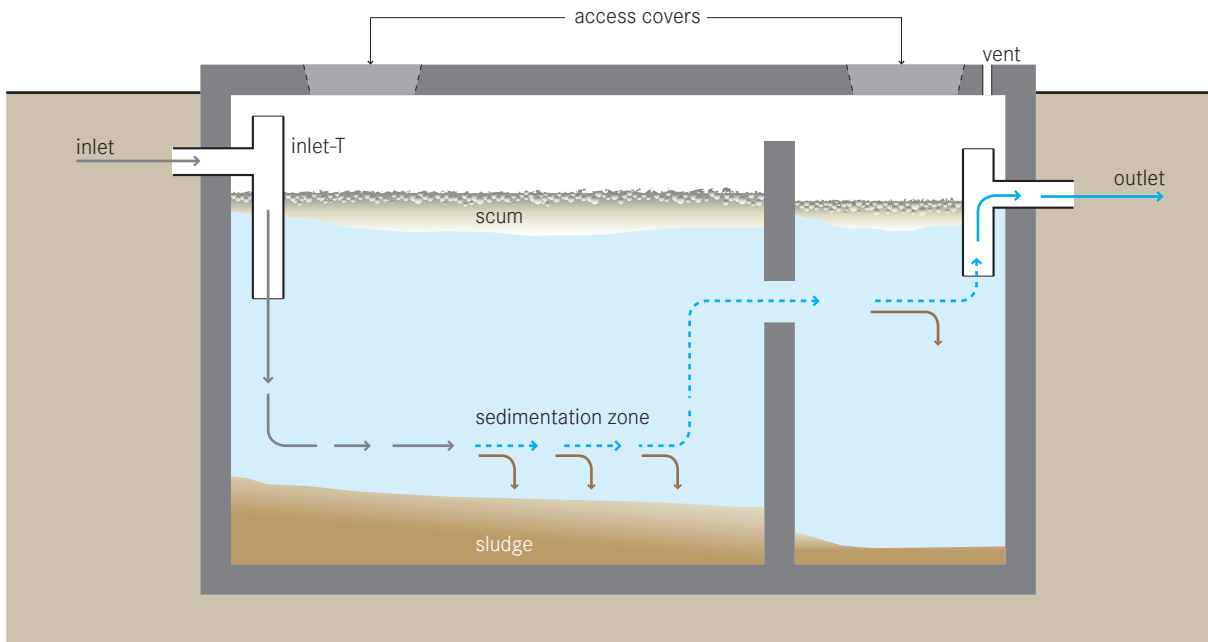

A septic tank is a watertight chamber made of concrete, fibreglass, or plastic, through which blackwater and greywater flows for primary treatment. Settling and anaerobic processes reduce solids and organics, but the treatment efficiency is only moderate.

Liquid flows through the tank and heavy particles sink to the bottom, while scum (mostly oil and grease) floats to the top. Over time, the solids that settle to the bottom are degraded anaerobically. However, the rate of accumulation is faster than the rate of decomposition and the accumulated sludge and scum must be periodically removed. The effluent of the septic tank must be dispersed by using a Soak Pit (R.5) or Leach Field (R.6), or transported to another treatment technology via a Solids-Free Sewer (C.4).

Generally, the removal of 50% of the solids, 30% to 40% of BOD and a 1-log removal of E. coli can be expected in a well-designed and maintained septic tank, although efficiencies vary greatly depending on operation and maintenance and climatic conditions.

Design Considerations A septic tank should have at least two chambers. The first chamber should be at least 50% of the total length; and when there are only two chambers, it should be two thirds of the total length. Most of the solids settle out in the first chamber. The baffle, or the separation between the chambers, is to prevent scum and solids from escaping with the effluent. A T-shaped outlet pipe further reduces the scum and solids that are discharged.

Accessibility to all chambers (through access cover) is necessary for maintenance. Septic tanks should be vented for controlled release of odorous and potentially harmful gases.

The design of a septic tank depends on the number of users, the amount of water used per capita, the average annual temperature, the desludging frequency and the characteristics of the wastewater. The retention time should be 48 hours to achieve moderate treatment.

To meet stricter discharge standards, BOD removal rates can be significantly increased by retrofitting a simple aeration system, e.g. a diaphragm air pump that blows air into the second compartment of the septic tank. Perforated pipes installed at the bottom of the tank distribute the air flow. This increases sludge

production and the intervals between the necessary desludging are shortened accordingly. However, a much better BOD removal can be achieved by retrofitting the septic tank with a Submerged Aerated Fixed-Film module (S.6, SAFF).

Appropriateness This technology is most commonly applied at the household level. Larger, multi-chamber septic tanks can be designed for groups of houses and/or public buildings (e.g. schools).

A septic tank is appropriate where there is a way of dispersing or transporting the effluent. If septic tanks are used in densely populated areas, onsite infiltration should not be used, otherwise, the ground will become oversaturated and contaminated, and wastewater may rise up to the surface, posing a serious health risk. Instead, the septic tanks should be connected to some type of Conveyance technology, through which the effluent is transported to a subsequent Treatment or Disposal site. Even though septic tanks are watertight, it is not recommended to construct them in areas with high groundwater tables or where there is frequent flooding.

Because the septic tank must be regularly desludged, a vacuum truck should be able to access the location. Often, septic tanks are installed in the home, under the kitchen or bathroom, which makes emptying difficult. Septic tanks can be installed in every type of climate, although the efficiency will be lower in colder climates. In colder climates, they are not efficient at removing nutrients and pathogens.

Health Aspects/Acceptance Under normal operating conditions, users do not come in contact with the influent or effluent. Effluent, scum and sludge must be handled with care as they contain high levels of pathogenic organisms. Users should be careful when opening the tank because noxious and flammable gases may be released.

Operation & Maintenance Because of the delicate ecology, care should be taken not to discharge harsh chemicals into the septic tank. Scum and sludge levels need to be monitored to ensure that the tank is functioning well. Generally, septic tanks should be emptied every 2 years. This is best done by using a Motorised Emptying and Transport technology (C.2). Septic tanks should be checked from time to time to ensure that they are watertight.

Pros & Cons

- + Simple and robust technology
- + No electrical energy is required
- + Low operating costs
- + Long service life
- + Small land area required
(can be built underground)
- Low reduction in pathogens, solids and organics
- Regular desludging must be ensured
- Effluent and sludge require further treatment and/or appropriate infiltration or discharge

References & Further Reading

can be found on page 241

Application Level:

- * Household
- ** Neighbourhood
- City

Management Level:

- ** Household
- ** Shared
- ** Public

Inputs: Blackwater Brownwater
 Greywater

Outputs: Effluent Sludge

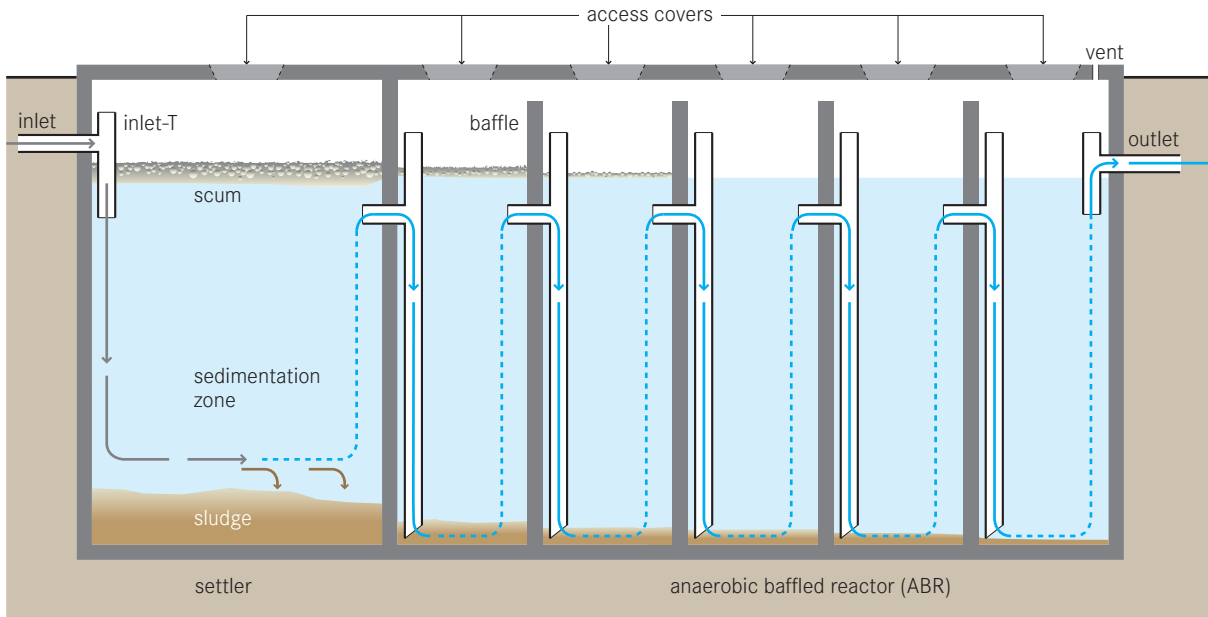

An Anaerobic Baffled Reactor (ABR) is an improved Septic Tank (S.3) with a series of baffles through which the wastewater is forced to flow. The increased contact time with the active biomass (sludge) results in improved treatment.

The upflow chambers provide enhanced removal and digestion of organic matter. BOD may be reduced by up to 90%, which is far superior to its removal in a conventional Septic Tank.

Design Considerations The majority of settleable solids are removed in a sedimentation chamber in front of the actual ABR. Small-scale, stand-alone units typically have an integrated settling compartment, but primary sedimentation can also take place in a separate Settler (T.1) or another preceding technology (e.g. existing Septic Tanks). Designs without a settling compartment (as shown in T.3) are of particular interest for (Semi-) Centralised Treatment plants that combine the ABR with another technology for primary settling, or where prefabricated, modular units are used. Typical inflows range from 2 to 200 m³ per day. Critical design parameters include a hydraulic retention time (HRT) between

48 to 72 hours, upflow velocity of the wastewater below 0,6 m/h and the number of upflow chambers (3 to 6). The connection between the chambers can be designed either with vertical pipes or baffles. Accessibility to all chambers (through access covers) is necessary for maintenance. Usually, the biogas produced in an ABR through anaerobic digestion is not collected because of its insufficient amount. The tank should be vented to allow for controlled release of odorous and potentially harmful gases.

Appropriateness This technology is easily adaptable and can be applied at the household level, in small neighbourhoods or even in bigger catchment areas. It is most appropriate where a relatively constant amount of blackwater and greywater is generated. A (semi-) centralised ABR (T.3) is appropriate when there is a pre-existing Conveyance technology, such as a Simplified Sewer (C.4). This technology is suitable for areas where land may be limited since the tank is most commonly installed underground and requires a small area. However, a vacuum truck should be able to access the location because the sludge must be regularly removed (particularly from the settler).

ABRs can be installed in every type of climate, although the efficiency is lower in colder climates where they are not efficient at removing nutrients and pathogens. The effluent usually requires further treatment.

Health Aspects/Acceptance Under normal operating conditions, users do not come in contact with the influent or effluent. Effluent, scum and sludge must be handled with care as they contain high levels of pathogenic organisms. The effluent contains odorous compounds that may have to be removed in a further polishing step. Care should be taken to design and locate the facility such that odours do not bother community members.

Operation & Maintenance An ABR requires a start-up period of several months to reach full treatment capacity since the slow growing anaerobic biomass first needs to be established in the reactor. To reduce start-up time, the ABR can be inoculated with anaerobic bacteria, e.g. by adding fresh cow dung or Septic Tank sludge. The added stock of active bacteria can then multiply and adapt to the incoming wastewater. Because of the delicate ecology, care should be taken not to discharge harsh chemicals into the ABR. Scum and sludge levels need to be monitored to ensure that the tank is functioning well. Process operation in

general is not required and maintenance is limited to the removal of accumulated sludge and scum every 1 to 3 years. This is best done using a Motorised Emptying and Transport technology (C.2). The desludging frequency depends on the chosen pre-treatment steps, as well as on the design of the ABR.

ABR tanks should be checked from time to time to ensure that they are watertight.

Pros & Cons

- + Resistant to organic and hydraulic shock loads
- + No electrical energy is required
- + Low operating costs
- + Long service life
- + High reduction of BOD
- + Low sludge production; the sludge is stabilised
- + Moderate area requirement (can be built underground)
- Requires expert design and construction
- Low reduction of pathogens and nutrients
- Effluent and sludge require further treatment and/or appropriate discharge

References & Further Reading

can be found on page 241

Application Level:

- * Household
- ** Neighbourhood
- City

Management Level:

- * Household
- ** Shared
- ** Public

Inputs: Blackwater Brownwater
 Greywater

Outputs: Effluent Sludge

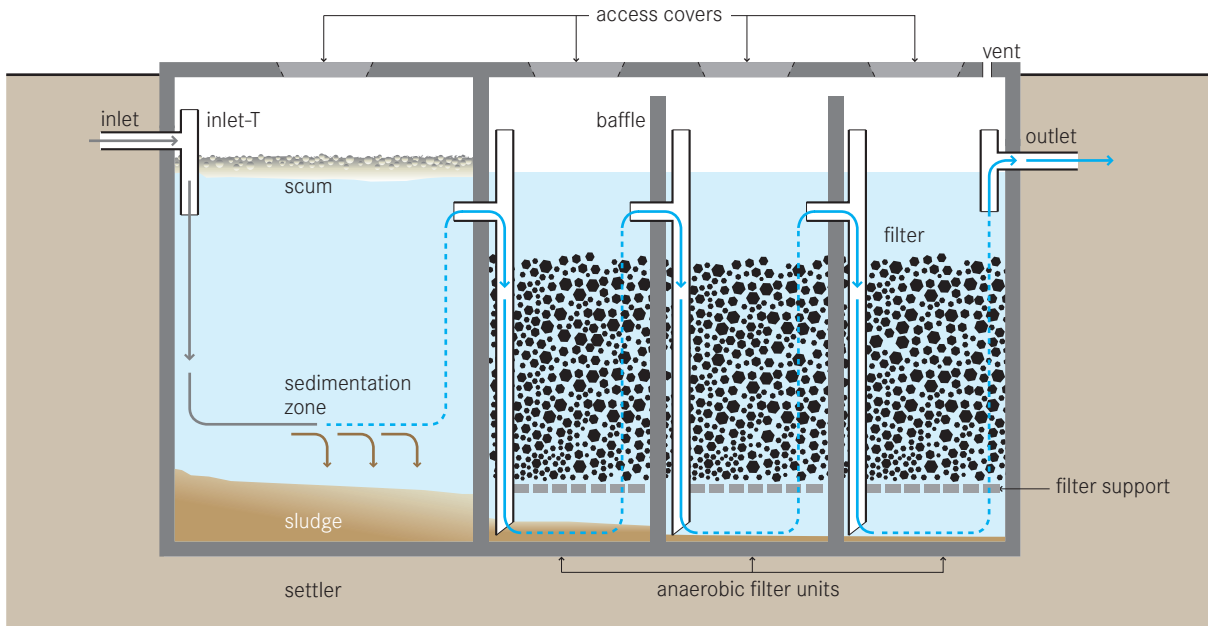

An Anaerobic Filter is a fixed-bed bioreactor with one or more filtration chambers in series. As wastewater flows through the filter, particles are trapped and organic matter is degraded by the active biomass that is attached to the surface of the filter media.

With this technology, suspended solids and BOD removal can be as high as 90%, but is typically between 50% and 80%. Nitrogen removal is limited and normally does not exceed 15% in terms of total nitrogen (TN).

Design Considerations Pre- and primary treatment is essential to remove solids and garbage that may clog the filter. The majority of settleable solids are removed in a sedimentation chamber in front of the anaerobic filter. Small-scale, stand-alone units typically have an integrated settling compartment, but primary sedimentation can also take place in a separate Settler (T.1) or another preceding technology (e.g. existing Septic Tanks). Designs without a settling compartment (as shown in T.4) are of particular interest for (Semi-) Centralised Treatment plants that combine the Anaerobic Filter with other technologies, such as the

Anaerobic Baffled Reactor (ABR, T.3). Anaerobic Filters are usually operated in upflow mode because there is less risk that the fixed biomass will be washed out. The water level should cover the filter media by at least 0.3 m to guarantee an even flow regime. The hydraulic retention time (HRT) is the most important design parameter influencing filter performance. An HRT of 12 to 36 hours is recommended.

The ideal filter should have a large surface area for bacteria to grow, with pores large enough to prevent clogging. The surface area ensures increased contact between the organic matter and the attached biomass that effectively degrades it. Ideally, the material should provide between 90 to 300 m² of surface area per m³ of occupied reactor volume. Typical filter material sizes range from 12 to 55 mm in diameter. Materials commonly used include gravel, crushed rocks or bricks, cinder, pumice, or specially formed plastic pieces, depending on local availability. The connection between the chambers can be designed either with vertical pipes or baffles. Accessibility to all chambers (through access covers) is necessary for maintenance. The tank should be vented to allow for controlled release of odorous and potentially harmful gases.

Appropriateness This technology is easily adaptable and can be applied at the household level, in small neighbourhoods or even in bigger catchment areas. It is most appropriate where a relatively constant amount of blackwater and greywater is generated. The Anaerobic Filter can be used for secondary treatment to reduce the organic loading rate for a subsequent aerobic treatment step, or for polishing.

This technology is suitable for areas where land may be limited since the tank is most commonly installed underground and requires a small area. Accessibility by vacuum truck is important for desludging.

Anaerobic Filters can be installed in every type of climate, although the efficiency is lower in colder climates where they are not efficient at removing nutrients and pathogens. Depending on the filter material, however, complete removal of worm eggs may be achieved. The effluent usually requires further treatment.

Health Aspects/Acceptance Under normal operating conditions, users do not come in contact with the influent or effluent. Effluent, scum and sludge must be handled with care as they contain high levels of pathogenic organisms. The effluent contains odorous compounds that may have to be removed in a further polishing step. Care should be taken to design and locate the facility such that odours do not bother community members.

Operation & Maintenance An Anaerobic Filter requires a start-up period of 6 to 9 months to reach full treatment capacity since the slow growing anaerobic biomass first needs to be established on the filter media. To reduce start-up time, the filter can be inoculated with anaerobic bacteria, e.g. by spraying Septic Tank sludge

onto the filter material. The flow should be gradually increased over time. Because of the delicate ecology, care should be taken not to discharge harsh chemicals into the anaerobic filter.

Scum and sludge levels need to be monitored to ensure that the tank is functioning well. Over time, solids will clog the pores of the filter. As well, the growing bacterial mass will become too thick, break off and eventually clog pores. When the efficiency decreases, the filter must be cleaned. This is done by running the system in reverse mode (backwashing) or by removing and cleaning the filter material.

Anaerobic Filter tanks should be checked from time to time to ensure that they are watertight.

Pros & Cons

- + No electrical energy is required
- + Low operating costs
- + Long service life
- + High reduction of BOD and solids
- + Low sludge production; the sludge is stabilised
- + Moderate area requirement (can be built underground)
- Requires expert design and construction
- Low reduction of pathogens and nutrients
- Effluent and sludge require further treatment and/or appropriate discharge
- Risk of clogging, depending on pre- and primary treatment
- Removing and cleaning the clogged filter media is cumbersome

References & Further Reading

can be found on page 241

Application Level:

- Household
 Neighbourhood
 City

Management Level:

- Household
 Shared
 Public

Inputs: Blackwater Greywater

Outputs: Effluent Sludge

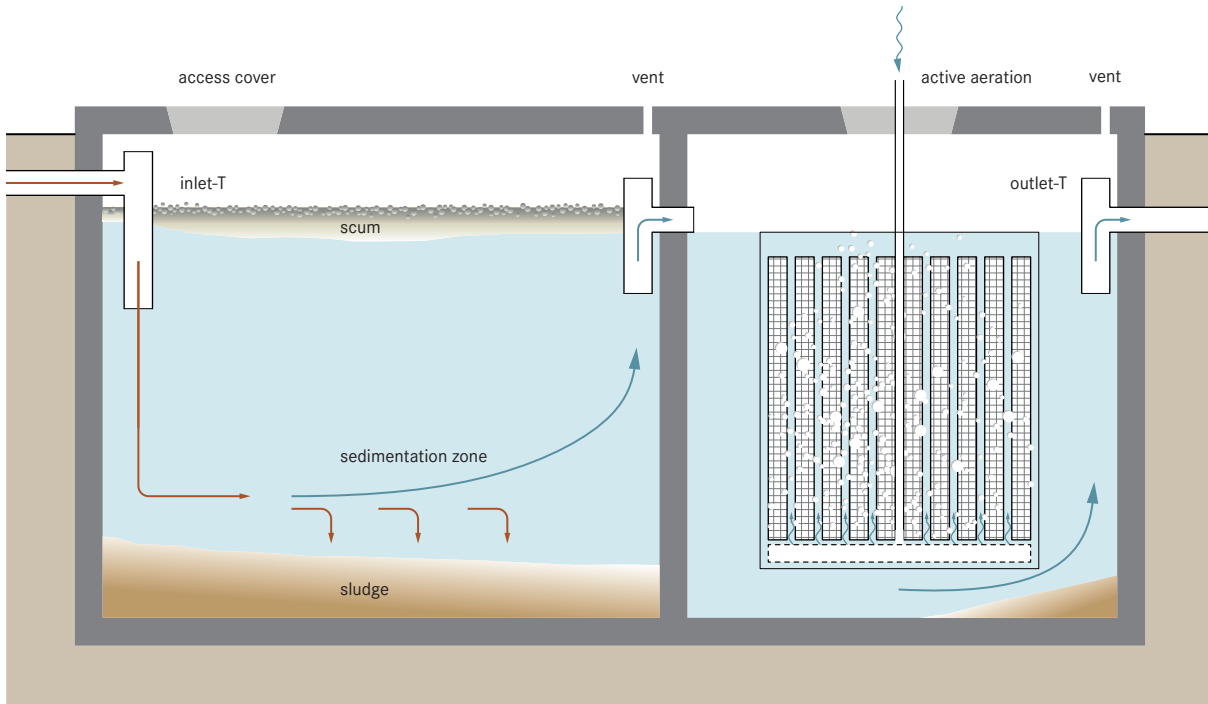

A Submerged Aerated Fixed-Film (SAFF) Reactor is a robust biological wastewater treatment process that employs an inert medium, such as rock, plastic, wood, or other natural or synthetic solid material that will support the growth of biomass on its surface. Alternatively, treatment technologies, such as Moving-Bed Biofilm Reactors (MBBR), Sequencing Batch Reactors (SBR) or Membrane Bioreactors (MBR), can offer similar performance at a comparable cost range. Thus, the SAFF presented here has been chosen to represent this range of comparable technologies.

SAFF units are installed in watertight chambers (usually underground) after primary treatment, such as a settling chamber or septic tank. This preliminary treatment is needed to retain solids and as a homogenisation step. A blower, normally installed outside the chamber, introduces air into the system. The flow of air provides oxygen to the biomass, ensures efficient mixing of the effluent and frees any excess solids from the medium, eliminating the need of a backwash system. The main function of the SAFF reactor is to reduce the concentration of organic material present in water (BOD

and COD reduction). It is common for this type of system to generate an effluent with BOD concentrations of 25 mg/l and less. Because the fixed biomass combines aerobic, anaerobic and anoxic zones, it can also reduce the concentration of ammonium NH_4 . Therefore, a SAFF reactor provides improved nitrification/denitrification performance over traditional systems, such as septic tanks.

Design Considerations The settling chamber before a SAFF unit should have a hydraulic retention time of at least 12 hours to ensure proper settlement of particles. Also, all large solids and floating scum should be removed before the inlet of the SAFF to prevent clogging of the media. The media for compact SAFF reactors is usually made of polypropylene sheets welded together to conform blocks that present a large contact area ($100 - 230 \text{ m}^2/\text{m}^3$) and free volume of over 90% for the attachment of biofilm (see illustration above).

A SAFF unit can be installed above ground level, but it is usually built underground following a septic tank or it can be retrofitted into existing tanks. When built underground, it is not noticeable from the outside.

Constant energy needs to be supplied to the blower (24/7) and the blower must be maintained regularly. SAFF reactors can be implemented modularly for groups of houses and/or public buildings (e.g. schools).

Appropriateness A SAFF can be installed in any type of climate, although the efficiency will be lower at lower temperatures. A SAFF reactor is appropriate where there is a way of infiltrating, dispersing or reusing the effluent. The high quality effluent prevents leach field (R.6) clogging and can be used for Application of Effluent/Irrigation (R.4).

Similar reflections apply to the alternative treatment technologies of this category. SBR's often are a cheaper choice, although they do not achieve the same BOD/ COD reduction or MBR's, which regularly achieve the highest treatment performance and are appropriate for especially sensitive locations. At the same time, they also have higher costs both for the initial investment and long-term operation due to the high cost of the membranes.

As mentioned in the previous section, the SAFF and its alternative technologies are well suited for retrofitting and upgrading existing septic tanks.

Health Aspects/Acceptance This technology is accepted as a simple and efficient retrofit and upgrade for Septic Tanks, as well as a stand-alone solution for new housing developments. Under normal operating conditions, users do not come in contact with the influent or effluent.

Operation & Maintenance Constant energy needs to be supplied to the blower (24/7) and periodic maintenance by a professional service provider is required. Because the septic tank or settling compartment must be regularly desludged, a vacuum truck should be able to access the location. Regarding the alternative technologies, the local availability of a professional service provider for occasional trouble shooting and periodic maintenance including spare parts may be the key factor for its sustainable functioning of the technology - certainly more important than the technology choice itself (whether SAFF, MBBR, SBR or MBR).

Pros & Cons

- + Robust technology with low maintenance requirements
- + No moving parts or mechanical components inside chamber
- + High-quality effluent
- + Small area required, usually built underground
- + 95-98% BOD reduction
- + Long service life
- Requires constant energy supply
- Regular desludging must be ensured
- Blower requires maintenance or replacement after approximately 10 years

References & Further Reading

can be found on page 242

The technologies in this section deal with the products generated at the User Interface or onsite Collection and Storage/Treatment technology by removing and/or transporting them to a subsequent offsite (Semi-) Centralised Treatment, Reuse and/or Disposal technology. They are either sewer-based technologies (C.3-C.5), or container-based human-powered or motorised emptying and transport technologies (C.1-C.2).

- C.1 Human-Powered Transport
- C.2 Motorised Emptying and Transport
- C.3 Simplified Sewer
- C.4 Solid-Free Sewer
- C.5 Conventional Sewer

In any given context, the technology choice generally depends on the following factors:

- Type and quantity of products to be transported
- Distance to cover
- Accessibility
- Topography
- Soil and groundwater characteristics
- Financial resources
- Availability of a service provider
- Management considerations



Application Level:	Management Level:	Inputs/Outputs:
<input type="checkbox"/> ** Household <input type="checkbox"/> *** Neighbourhood <input type="checkbox"/> City	<input type="checkbox"/> Household <input type="checkbox"/> * Shared <input type="checkbox"/> ** Public	<input type="checkbox"/> Urine <input type="checkbox"/> Faeces

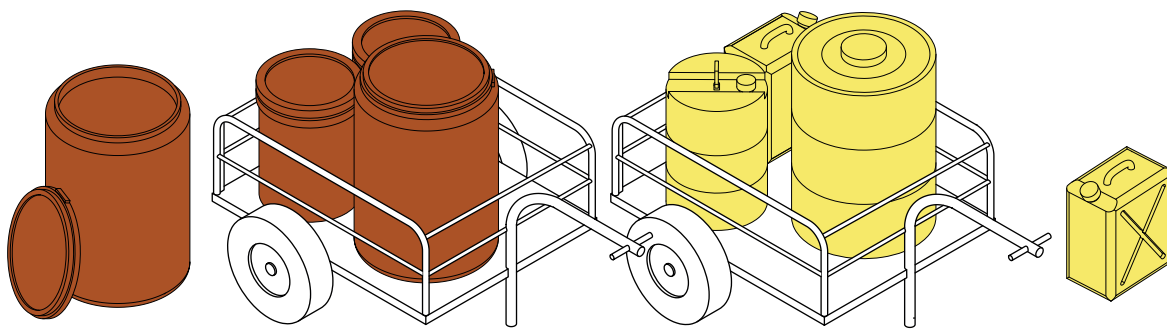

Human-Powered Transport in this Compendium refers to the different ways by which people can manually collect and transport sealed containers with urine and/or faeces as an element of Container Based Sanitation (CBS). In most cases, the sealable, removable containers are collected and transported from the customer's user interface first to a depot, from where they are picked-up and transferred to the treatment site by a motorised vehicle (C.2). However, if proximity allows, the containers may be manually transported directly to the treatment site.

CBS has been deployed in response to natural disasters and refugee crises and has demonstrated its effectiveness in these settings. CBS is particularly suitable for urban areas with a high population density, where the high costs and associated technical challenges make conventional sewered sanitation impossible and local conditions, such as a lack of space, insufficient or unreliable water supply, a high groundwater table or risk of flooding, prohibit the installation and emptying of on-site sanitation facilities. Human-powered transport forms an essential step in the CBS end-to-end service chain.

In addition to the locally available equipment, the choice of the most appropriate conveyance technology depends on the accessibility to the user sites, the distances to the depot and from there to the treatment facilities, as well as the way in which the emptied containers are returned to the depots and to the customers.

Most CBS service providers collect the containers either from within the customer's home or from their front door. In hard-to-reach areas, customers can be asked to take their containers to a drop-off point, where they will receive sanitised empty containers in return.

Specially adapted wheelbarrows and hand- or push carts are used to transport the containers directly to the treatment plant or to a depot, where the containers are stored until the required quantity is reached to load a truck for further motorised onward transport to the plant. After emptying, washing and sanitising, the containers are returned to the customer by the same route. The frequency of collection depends on the customer's available storage capacity and other factors, such as climatic conditions, if these allow for longer storage without creating unpleasant conditions at the storage site.

Most toilets used in CBS are urine diverting (U.4). The faeces are usually collected in a container (S.1) and urine is diverted into a second collection tank or into on-site soakaways/ infiltration pits (R.5). Human-powered hand or push carts are also used to transport urine containers over short distances to the field of direct application (R.1). The transport of urine containers requires special care and sealing because of the liquid content.

Design Considerations The urine containers can either be transported directly or emptied into larger transport containers. Where urine-diversion systems are common (i.e. Systems 5 and 6), a micro-enterprise may specialise in the collection and transport of jerrycans and small containers, using e.g. bicycles, donkeys or handcarts. Handcarts should be designed according to the weight to be transported and the manoeuvrability on narrow, unpaved paths. Special attention should be paid to the size and width of the tires to avoid getting stuck on unpaved paths. Single-axle carts should have a support that allows them to stand securely, even when fully loaded. However, this support should not affect the manoeuvrability. The handles must be at a comfortable height for the operator and are best protected with rubber grips.

The careful and well-thought-out provision of depots or transfer stations can ensure an adequate combination of C.1 and C.2 into an efficient and convenient conveyance solution. Optimised transport routes and distances are crucial for the viability of such a conveyance service.

Appropriateness A well-sealed jerrycan is an effective way of hand transporting urine over short distances. This type of transport is only appropriate for areas where the points of generation and use (i.e. homes and fields) or drop-off (depot) are close together. The use of wheelbarrows, handcarts and cargo bicycles facilitates the transport of containers for urine and/ or faeces. Human-Powered Transport is suitable for areas with narrow paths that are not accessible for motorised transport. The low investment cost and easy maintenance are the main advantages for transport over short distances. Compared to motorised transport, they are slower and physically more demanding.

Health Aspects/Acceptance Compared to the emptying and handling of faecal sludge from pit latrines, the collection and transport of sealed containers in CBS systems pose a substantially lower risk to public health. Nevertheless, the labour-intensive nature of CBS service provision can pose a potential health and safety risk, especially during epidemics of infectious diseases. Wearing personal protective equipment, such as boots, gloves and face masks, along with appropriate clothing is mandatory for operators. Regular health checks for all employees are recommended. Proper cleaning and disinfection of the containers are important measures to reduce the health risks to users of CBS systems.

Operation & Maintenance Containers must be carefully sealed before handling. Loading and unloading of the carts must be done carefully to avoid accidental opening of the containers. The carts, including the tire pressure, must be checked regularly. Cleaning the carts after each use is essential and should be done in a suitable place to avoid environmental pollution.

Pros & Cons

- + Potential for local job creation and income generation
- + Wheelbarrows, hand and pushcarts are locally available everywhere and can be repaired with locally available materials
- + Low capital costs; variable operating costs depending on transport distance
- + Provides services to areas/communities without sewers and road access
- Spills can happen which could pose potential health risks and generate offensive smells
- Time consuming and labour-intensive
- Depending on the context, acceptance may be hard to achieve

References & Further Reading

can be found on page 242

Application Level:

- ** Household
- ** Neighbourhood
- * City

Management Level:

- Household
- * Shared
- ** Public

Inputs/Outputs:

- Sludge
- Blackwater
- Wastewater
- Effluent
- Urine
- Stored urine
- Faeces

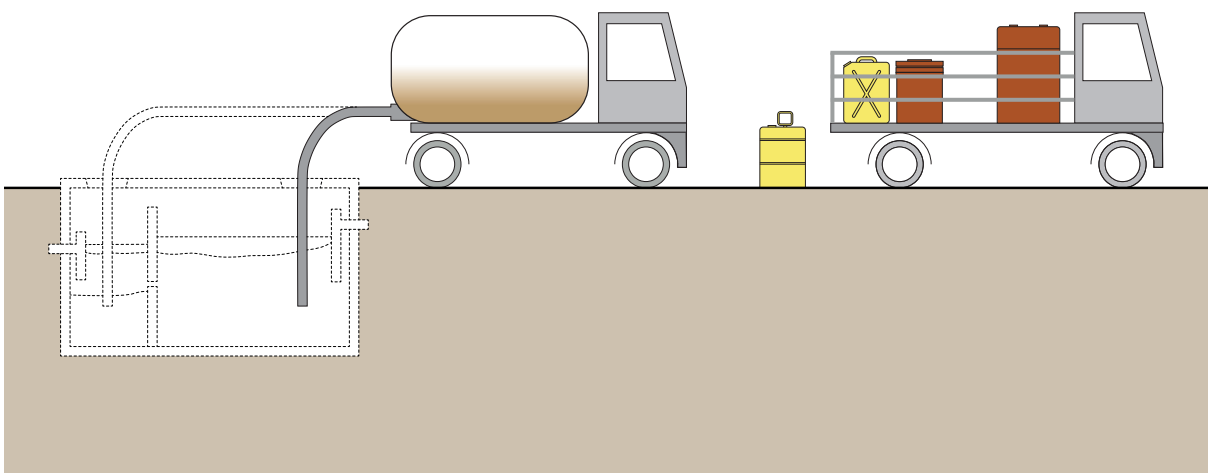

Motorised Emptying and Transport refers to motorised vehicles equipped with a motor pump and a tank for emptying and transporting faecal sludge and urine from Storage and Treatment Technologies (S.1-6). It also refers to motorised vehicles that transport containers with faeces or urine as part of Container Based Sanitation. People are required to operate the pump or to load and unload the vehicle with containers.

Trucks that are fitted with a vacuum pump are often referred to as vacuum trucks. For emptying, the pump is connected to a hose that is lowered down into the tank (e.g. Septic Tank, S.3) and the sludge is sucked into the holding tank on the vehicle. A comprehensive overview of available emptying technologies for pits and tanks is available from the Faecal Sludge Management Alliance (see references).

Design Considerations Generally, the storage capacity of a vacuum truck is between 3 and 12 m³. There are a variety of designs but most common are vehicles with a vacuum pump and a cylinder round tank, a form that better resists the vacuum force.

Local trucks are also adapted for sludge transport by equipping them with holding tanks and pumps. Modified pick-ups and tractor trailers can transport around 1.5 m³, but capacities vary.

Vacuum pumps can usually only evacuate to a depth of 2 to 3 m from the top of the tank (depending on the strength of the pump and the viscosity of the sludge) and should be located within 30 m of the tank to be emptied. For trucks with more powerful vacuum pumps, the distance can be up to 50 m. In general, the closer the vacuum pump is to the tank, the easier it is to empty.

Pick-ups or conventional trucks are used to transport containers. No special modifications are required, but the loading area must have a railing with sufficient height to secure the containers and prevent them from falling down.

Appropriateness For emptying the collection and storage tanks, vacuum trucks are the most used technology. Although large vacuum trucks cannot access areas with narrow or non-drivable roads, they remain the most common sanitation solution for municipalities and sanitation authorities, either with

publicly owned and operated vehicles or managed by private emptying services. Trucks can rarely make long-distance trips from an emptying site to a treatment plant, since the income generated may not offset the cost of fuel and time. Therefore, the treatment site must be within reach from the serviced areas.

Solid waste and sand make emptying much more difficult and can clog the pipe or pump. Depending on the size of the vacuum truck, multiple truckloads may be required for large Septic Tanks (S.3), e.g. of commercial or public buildings.

Motorised transport of containers with urine and faeces is best suited for areas with wider, year-round passable roads and is used in some CBS systems for transport from depots or pickup points to treatment plants in combination with Human-Powered Transport (C.1).

Both the sanitation authority and private entrepreneurs may operate vacuum trucks, although the price and level of service may vary significantly. Private operators may charge less than public ones, but may only afford to do so if they do not discharge the sludge at a certified facility. Private and municipal service providers should work together to cover the whole faecal sludge management chain.

Health Aspects/Acceptance The use of a motorised emptying and transport service is fundamentally necessary when the on-site Collection and Storage/Treatment technology is not connected to the sewer system and there is no option for on-site reuse or disposal. Discharge of truck loads to proper treatment facilities is mandatory. Serious health and environmental risks occur if “wild” discharge is practised on unsuitable areas or in water bodies.

Operators must wear personal protective equipment, such as boots, gloves and face masks and spillage of wastewater must be avoided when disconnecting suction pipes. Cleaning trucks and equipment on public roads must also be avoided.

The same applies to the transport of faecal containers, where personnel should wear personal protective equipment and handle the containers carefully to avoid accidentally opening them during transport.

There are ISO Standards as guidelines for the

assessment and improvement of sanitation services, including motorised emptying and transport (see Part 3 Cross-Cutting Issues).

Operation & Maintenance The vacuum trucks have to be cleaned after daily use and regularly deep cleaned and disinfected. Cleaning should be done in appropriate locations where the cleaning wastewater does not discharge into water bodies. The same applies to vehicles transporting faecal containers.

As with any engine or vehicle, regular maintenance of the truck, including the vacuum pump and technical equipment is essential. Regular safety checks are strongly recommended to avoid accidents with loaded vehicles.

In collection and storage tanks with long emptying intervals, the sludge can settle and thicken at the bottom, making it harder to extract the solids. For this reason, it is recommended that septic or holding tanks be emptied periodically, even if the sludge level is not at its maximum.

Pros & Cons

- + Fast, hygienic and generally effective sludge removal
- + Efficient transport service for effluent can be established with vacuum trucks
- + Trucks can be used for efficient container transport in CBS systems
- + Potential for local job creation and income generation
- + Provides an essential service to unsewered areas
- Garbage in tanks may block hoses and pumps
- Difficulties may occur when emptying deep tanks due to limited suction power
- Very high capital costs; variable operating costs depending on use and maintenance
- Hiring a vacuum truck may be unaffordable for poor households
- Not all parts and materials may be locally available
- May have difficulties with access

References & Further Reading

can be found on page 242

Application Level:

- Household
 Neighbourhood
 City

Management Level:

- Household
 Shared
 Public

Inputs/Outputs:

- Blackwater
 Brownwater Greywater Effluent

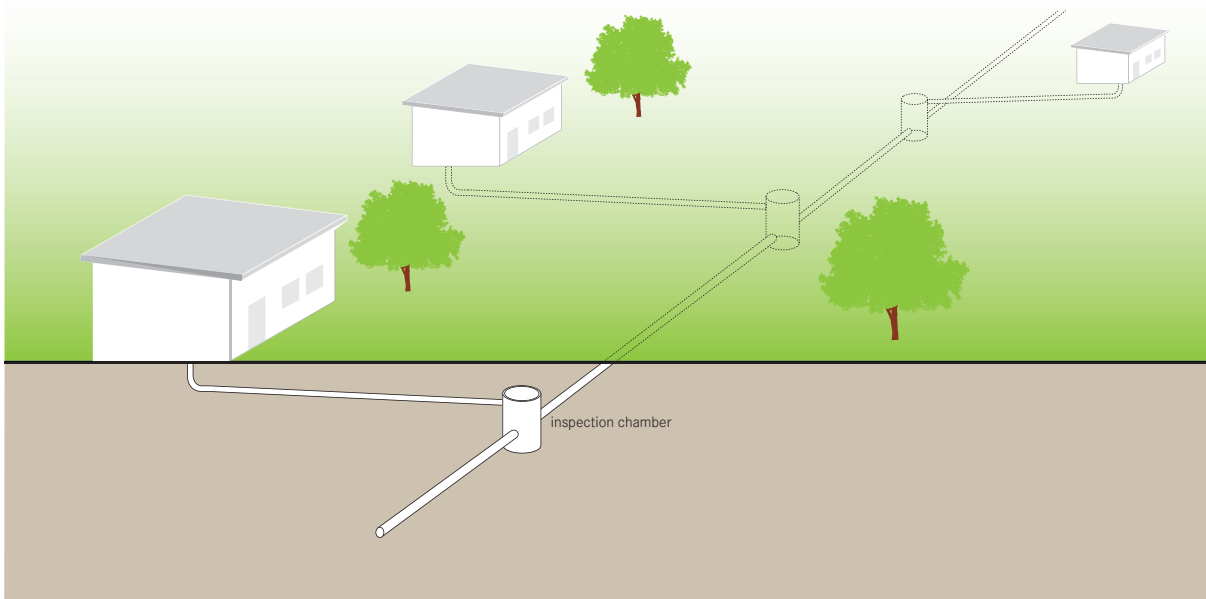

A Simplified Sewer describes a sewerage network that is constructed using smaller diameter pipes laid at a shallower depth and at a flatter gradient than Conventional Sewers (C.5). The Simplified Sewer allows for a more flexible design at lower costs.

Conceptually, Simplified Sewerage is the same as Conventional Gravity Sewerage, but without unnecessarily conservative design standards and with design features that are better adapted to the local situation. The pipes are usually laid within the property boundaries, through either the back or front yards, rather than beneath the central road, allowing for fewer and shorter pipes. Because Simplified Sewers are typically installed within the condominium, they are often referred to as condominial sewers. The pipes can also be routed in access ways, which are too narrow for heavy traffic, or underneath pavements (sidewalks). Since Simplified Sewers are installed where they are not subjected to heavy traffic loads, they can be laid at a shallow depth and little excavation is required.

Design Considerations In contrast to Conventional Sewers that are designed to ensure a minimum self-cleansing velocity, the design of Simplified Sewers is based on a minimum tractive tension of 1 N/m^2 (1 Pa) at peak flow. The minimum peak flow should be 1.5 L/s and a minimum sewer diameter of 4" is required. A gradient of 0.5% is usually sufficient. For example, a 4" sewer laid at a gradient of 1 m in 200 m will serve around 2 800 users with a wastewater flow of 60 L/person/day.

PVC pipes are recommended to use. The depth at which they should be laid depends mainly on the amount of traffic. Below sidewalks, depths of 40 to 65 cm are typical. The simplified design can also be applied to sewer mains; they can also be laid at a shallow depth, provided that they are placed away from traffic.

Expensive manholes are normally not needed. At each junction or change in direction, simple inspection chambers (or cleanouts) are sufficient. Inspection boxes are also used at each house connection. Where kitchen greywater contains an appreciable amount of oil and grease, the installation of grease traps (see PRE, p. 76) is recommended to prevent clogging. Greywater should be discharged into the sewer to ensure adequate

hydraulic loading, but stormwater connections should be discouraged. However, in practice, it is difficult to exclude all stormwater flows, especially where there is no alternative for storm drainage. The design of the sewers (and treatment plant) should, therefore, take into account the extra flow that may result from stormwater inflow.

Appropriateness Simplified Sewers can be installed in almost all types of settlements and are especially appropriate for dense urban areas where space for onsite technologies is limited. They should be considered as an option where there is a sufficient population density (about 150 people per hectare) and a reliable water supply (at least 60 L/person/day).

Where the ground is rocky or the groundwater table high, excavation may be difficult. Under these circumstances, the cost of installing sewers is significantly higher than in favourable conditions. Regardless, simplified sewerage is between 20 and 50% less expensive than Conventional Sewerage.

Health Aspects/Acceptance If well-constructed and maintained, sewers are a safe and hygienic means of transporting wastewater. Users must be well trained regarding the health risks associated with removing blockages and maintaining inspection chambers.

Operation & Maintenance Trained and responsible users are essential to ensure that the flow is undisturbed and to avoid clogging by trash and other

solids. Occasional flushing of the pipes is recommended to insure against blockages. Blockages can usually be removed by opening the cleanouts and forcing a rigid wire through the pipe. Inspection chambers must be periodically emptied to prevent grit overflowing into the system. The operation of the system depends on clearly defined responsibilities between the sewerage authority and the community. Ideally, households will be responsible for the maintenance of pre-treatment units and the condominial part of the sewer. However, in practice, this may not be feasible because users may not detect problems before they become severe and costly to repair. Alternatively, a private contractor or users committee can be hired to do the maintenance.

Pros & Cons

- + Can be laid at a shallower depth and flatter gradient than Conventional Sewers
- + Lower capital costs than Conventional Sewers; low operating costs
- + Can be extended as a community grows
- + Greywater can be managed concurrently
- + Does not require onsite primary treatment units
- Requires repairs and removals of blockages more frequently than a Conventional Gravity Sewer
- Requires expert design and construction
- Leakages pose a risk of wastewater exfiltration and groundwater infiltration and are difficult to identify

References & Further Reading

can be found on page 242

Application Level:

- Household
 Neighbourhood
 City

Management Level:

- Household
 Shared
 Public

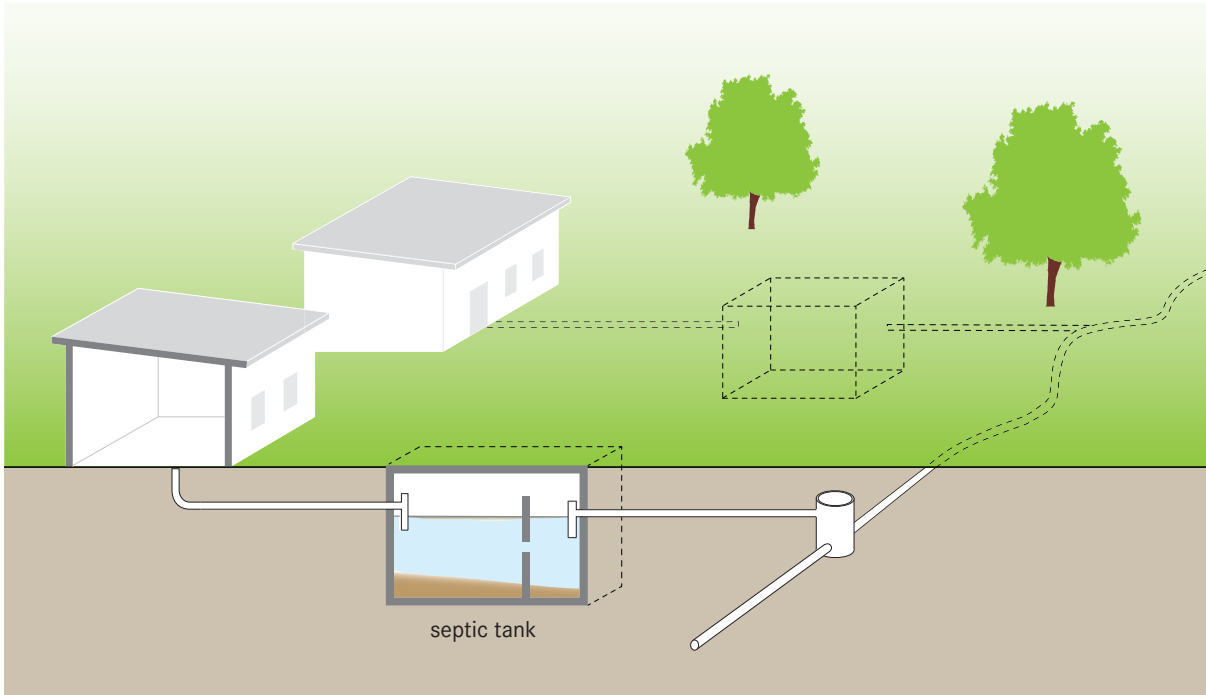
Inputs/Outputs:  Effluent

A Solids-Free Sewer is a network of small-diameter pipes that transport pre-treated and solids-free wastewater (such as Septic Tank effluent). It can be installed at a shallow depth and does not require a minimum wastewater flow or slope to function.

Solids-Free Sewers are also referred to as settled, small-bore, variable-grade gravity, or septic tank effluent gravity sewers. A precondition for Solids-Free Sewers is efficient primary treatment at the household level. An interceptor, typically a single-chamber Septic Tank (S.3), captures settleable particles that could clog small pipes. The solids interceptor also functions to attenuate peak discharges. Because there is little risk of depositions and clogging, solids-free sewers do not have to be self-cleansing, i.e. no minimum flow velocity or tractive tension is needed. They require few inspection points, can have inflective gradients (i.e. negative slopes) and follow the topography. When the sewer roughly follows the ground contours, the flow is allowed to vary between open channel and pressure (full-bore) flow.

Design Considerations If the interceptors are correctly designed and operated, this type of sewer does not require self-cleansing velocities or minimum slopes. Even inflective gradients are possible, as long as the downstream end of the sewer is lower than the upstream end. In sections where there is pressure flow, the water level in any interceptor tank must be higher than the hydraulic head within the sewer, otherwise the liquid will flow back into the tank. At high points in sections with pressure flow, the pipes must be ventilated. Solids-free sewers do not have to be installed on a uniform gradient with a straight alignment between inspection points. The alignment may curve to avoid obstacles, allowing for greater construction tolerance. A minimum diameter of 100 mm (4") is required to facilitate cleaning.

Expensive manholes are not needed because access for mechanical cleaning equipment is not necessary. Cleanouts or flushing points are sufficient and are installed at upstream ends, high points, intersections, or major changes in direction or pipe size. Compared to manholes, cleanouts can be more tightly sealed to prevent stormwater from entering. Stormwater must be excluded as it could exceed pipe capacity and lead to

blockages due to grit depositions. Ideally, there should not be any storm- and groundwater in the sewers, but, in practice, some imperfectly sealed pipe joints must be expected. Estimates of groundwater infiltration and stormwater inflow must, therefore, be made when designing the system. The use of PVC pipes can minimise the risk of leakage.

Appropriateness This type of sewer is best suited to medium-density (peri-)urban areas and less appropriate in low-density or rural settings. It is most appropriate where there is no space for a Leach Field (D.8), or where effluents cannot otherwise be disposed of onsite (e.g. due to low infiltration capacity or high groundwater). It is also suitable where there is undulating terrain or rocky soil. A Solids-Free Sewer can be connected to existing Septic Tanks where infiltration is no longer appropriate (e.g. due to increased housing density and/or water use).

As opposed to a Simplified Sewer (C.3), a Solids-Free Sewer can also be used where domestic water consumption is limited.

This technology is a flexible option that can be easily extended as the population grows. Because of shallow excavations and the use of fewer materials, it can be built at a considerably lower cost than a Conventional Sewer (C.5).

Health Aspects/Acceptance If well-constructed and maintained, sewers are a safe and hygienic means of transporting wastewater. Users must be well trained regarding the health risks associated with removing blockages and maintaining interceptor tanks.

Operation & Maintenance Trained and responsible users are essential to avoid clogging by trash and other solids. Regular desludging of the Septic Tanks is critical to ensure optimal performance of the sewer. Periodic flushing of the pipes is recommended to insure against blockages.

Special precautions should be taken to prevent illegal connections, since it is likely that interceptors would not be installed and solids would enter the system.

The sewerage authority, a private contractor or users

committee should be responsible for the management of the system, particularly, to ensure that the interceptors are regularly desludged and to prevent illegal connections.

Pros & Cons

- + Does not require a minimum gradient or flow velocity
- + Can be used where water supply is limited
- + Lower capital costs than conventional gravity sewers; low operating costs
- + Can be extended as a community grows
- + Greywater can be managed concurrently
- Space for interceptors is required
- Interceptors require regular desludging to prevent clogging
- Requires training and acceptance to be used correctly
- Requires repairs and removals of blockages more frequently than a conventional gravity sewer
- Requires expert design and construction
- Leakages pose a risk of wastewater exfiltration and groundwater infiltration and are difficult to identify

References & Further Reading

can be found on page 243

Application Level:	Management Level:	Inputs/Outputs:
<input type="checkbox"/> Household <input checked="" type="checkbox"/> * Neighbourhood <input checked="" type="checkbox"/> ** City	<input type="checkbox"/> Household <input type="checkbox"/> Shared <input checked="" type="checkbox"/> ** Public	<input checked="" type="checkbox"/> Blackwater <input checked="" type="checkbox"/> Brownwater <input type="checkbox"/> Greywater (<input checked="" type="checkbox"/> Stormwater)

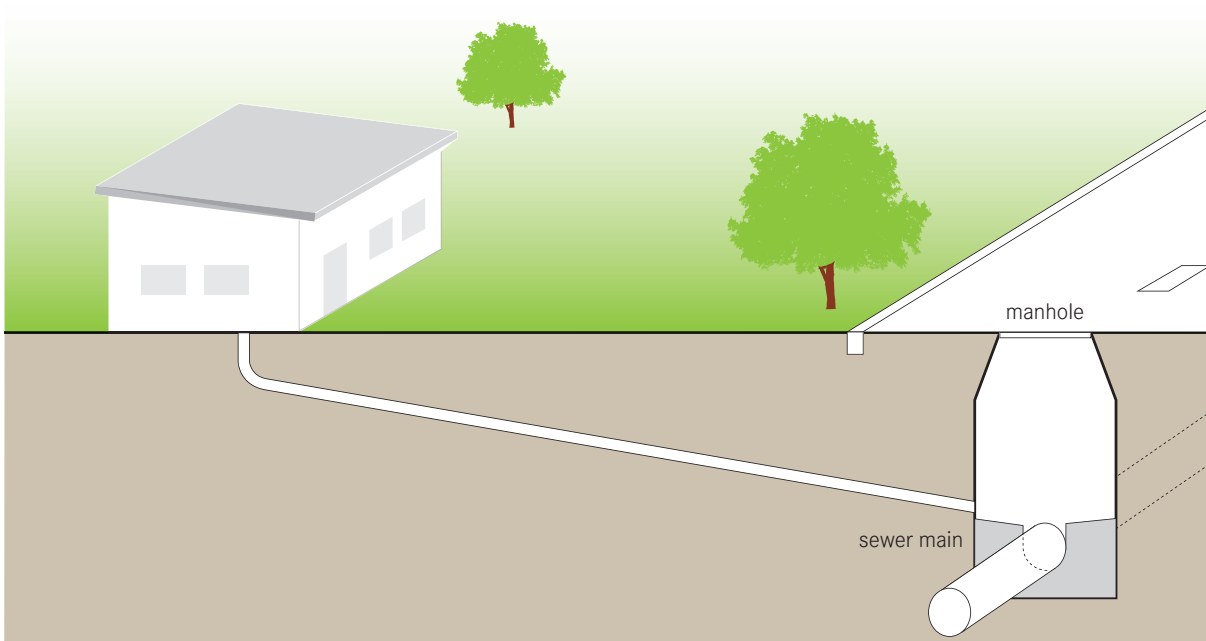

Conventional Sewers are large networks of underground pipes that convey blackwater, greywater and, in many cases, stormwater from individual households to a (Semi-) Centralised Treatment facility, using gravity (and pumps when necessary).

The Conventional Sewer system is designed with many branches. Typically, the network is subdivided into primary (main sewer lines along main roads), secondary and tertiary networks (networks at the neighbourhood and household level).

Design Considerations Conventional Sewers normally do not require onsite pre-treatment, primary treatment or storage of the household wastewater before it is discharged. The sewer must be designed, however, so that it maintains self-cleansing velocity (i.e. a gravity driven flow that will not allow particles to accumulate). For typical sewer diameters, a minimum velocity of 0.6 to 0.7 m/s during peak dry weather conditions should be adopted. A constant downhill gradient must be guaranteed along the length of the sewer to maintain self-cleansing flows, which can

require deep excavations. When a downhill grade cannot be maintained, a pumping station must be installed. Primary sewers are laid beneath roads, at depths of 1.5 to 3 m to avoid damages caused by traffic loads. The depth also depends on the groundwater table, the lowest point to be served (e.g. a basement) and the topography. The selection of the pipe diameter depends on the projected average and peak flows. Commonly used materials are concrete, PVC and ductile or cast iron pipes.

Access manholes are placed at set intervals above the sewer, at pipe intersections and at changes in pipeline direction (vertically and horizontally). Manholes should be designed such that they do not become a source of stormwater inflow or groundwater infiltration.

In the case that connected users discharge highly polluted wastewater (e.g. industry or restaurants), onsite pre- and primary treatment may be required before discharge into the sewer system to reduce the risk of clogging and the load of the wastewater treatment plant.

When the sewer also carries stormwater (known as a combined sewer), sewer overflows are required to avoid hydraulic surcharge of treatment plants during rain

events. However, combined sewers should no longer be considered state of the art. Rather, local retention and infiltration of stormwater or a separate drainage system for rainwater are recommended. The wastewater treatment system then requires smaller dimensions and is, therefore, cheaper to build and there is a higher treatment efficiency for less diluted wastewater.

Appropriateness Because they can be designed to carry large volumes, Conventional Sewers are very appropriate to transport wastewater to a (Semi-) Centralised Treatment facility.

Planning, construction, operation and maintenance require expert knowledge. Construction of Conventional Sewer systems in dense, urban areas is complicated because it disrupts urban activities and traffic. Conventional Sewers are expensive to build and, because the installation of a sewer line is disruptive and requires extensive coordination between authorities, construction companies and property owners, a professional management system must be in place.

Ground shifting may cause cracks in manhole walls or pipe joints, which may become a source of groundwater infiltration or wastewater exfiltration and compromise the performance of the sewer.

Conventional Sewers can be constructed in cold climates as they are dug deep into the ground and the large and constant water flow resists freezing.

Health Aspects/Acceptance If well-constructed and maintained, sewers are a safe and hygienic means of transporting wastewater. This technology provides a high level of hygiene and comfort for the user. However, because the waste is conveyed to an offsite location for treatment, the ultimate health and environmental impacts are determined by the treatment provided by the downstream facility.

Operation & Maintenance Manholes are used for routine inspection and sewer cleaning. Debris (e.g. grit, sticks or rags) may accumulate in the manholes and block the lines. To avoid clogging caused by grease, it is important to inform the users about proper oil and grease disposal. Common cleaning methods

for Conventional Sewers include rodding, flushing, jetting and bailing. Sewers can be dangerous because of toxic gases and should be maintained only by professionals, although, in well-organised communities, the maintenance of tertiary networks might be handed over to a well-trained group of community members. Proper protection should always be used when entering a sewer.

Pros & Cons

- + Less maintenance compared to Simplified and Solids-Free Sewers
- + Greywater and possibly stormwater can be managed concurrently
- + Can handle grit and other solids, as well as large volumes of flow
- Very high capital costs; high operation and maintenance costs
- A minimum velocity must be maintained to prevent the depositing of solids in the sewer
- Requires deep excavations
- Difficult and costly to extend as a community changes and grows
- Requires expert design and construction and maintenance
- Leakages pose a risk of wastewater exfiltration and groundwater infiltration and are difficult to identify

References & Further Reading

can be found on page 243

This section describes the treatment technologies generally appropriate for large user groups (i.e. from semi-centralised applications at the neighbourhood level to centralised, city level applications). They are designed to accommodate increased volumes of flow and provide, in most cases, improved removal of nutrients, organics and pathogens, especially when compared with small household-level treatment technologies (S). However, the operation, maintenance and energy requirements of the technologies within this functional group are generally higher than for smaller-scale technologies at the S level.

The technologies are divided into two groups: T.1-T.13 are primarily for the treatment of Blackwater, Brownwater, Greywater or Effluent, whereas T.14-T.19 are mainly for the treatment of Sludge. Technologies for pre-treatment and post-treatment are also described (technology information sheets PRE and POST), even though they are not always required. In consultation with the IWA Specialist Group, technologies referred to as “Constructed Wetlands” in previous Compendia, are now “Wetlands” (T.7-T.10).

PRE Pre-Treatment Technologies

T.1 Settler

T.2 Imhoff Tank

T.3 Anaerobic Baffled Reactor (ABR)

T.4 Anaerobic Filter

T.5 Waste Stabilisation Ponds (WSP)

T.6 Aerated Pond

T.7 Free-Water Surface Wetland (FWSW)

T.8 Horizontal Flow Wetland (HFW)

T.9 Vertical Flow Wetland (VFW)

T.10 Floating Treatment Wetland (FTW)

T.11 Trickling Filter

T.12 Upflow Anaerobic Sludge Blanket Reactor (UASB)

T.13 Activated Sludge

T.1-T.13

Technologies for the treatment of Blackwater, Brownwater, Greywater or Effluent

T.14 Sedimentation/Thickening Ponds

T.15 Unplanted Drying Beds

T.16 Planted Drying Beds

T.17 Co-Composting

T.18 Biogas Reactor

T.19 Carbonisation

T.14-T.19

Technologies for the treatment of Sludge

POST Tertiary Filtration and Disinfection

When designing a (Semi-) Centralised Treatment scheme, the engineer must create a meaningful combination of these technologies in order to achieve the desired overall treatment objective (e.g. a multiple-stage configuration for pre-treatment, primary treatment and secondary treatment). In any given context, the technology choice generally depends on the following factors (also check Part 3 for more):

- Type and quantity of products to be treated (including future developments)
- Desired output product (end-use and/or legal quality requirements)
- Financial resources
- Local availability of materials
- Availability of space
- Soil and groundwater characteristics
- Availability of a constant source of electricity
- Skills and capacity (for design and operation)
- Management considerations

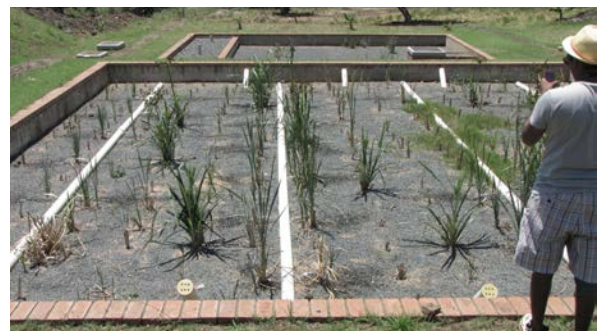

Application Level:

- * Household
- ** Neighbourhood
- ** City

Management Level:

- * Household
- * Shared
- ** Public

Inputs: Blackwater Brownwater
 Greywater Sludge

Outputs: Blackwater Brownwater
 Greywater Sludge Pre-Treatment Products

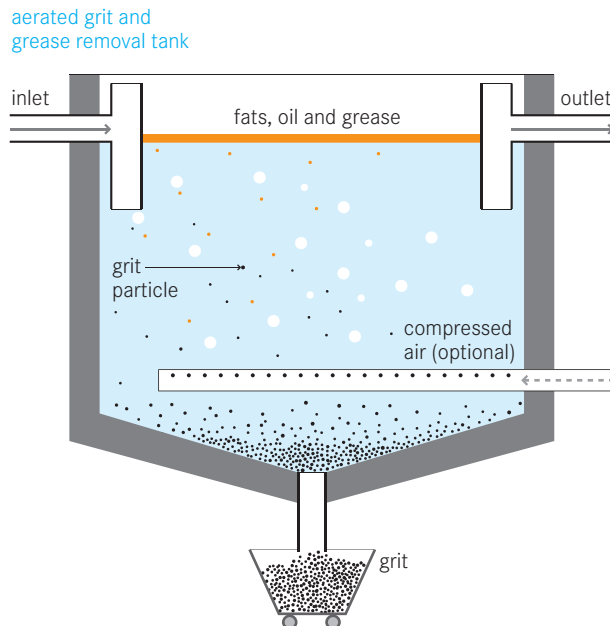
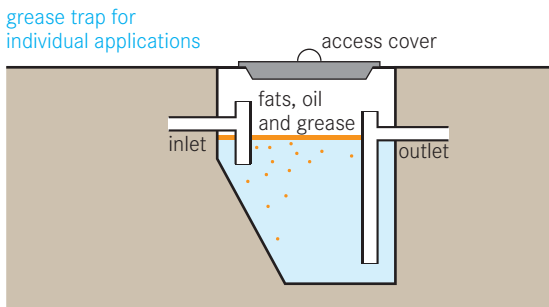
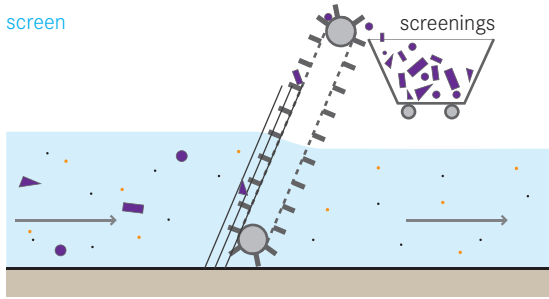

Pre-Treatment is the preliminary removal of wastewater or sludge constituents, such as oil, grease and various solids (e.g. sand, fibres and trash). Built before a Conveyance or Treatment technology, pre-treatment units can retard the accumulation of solids and minimise subsequent blockages. They can also help reduce abrasion of mechanical parts and extend the life of the sanitation infrastructure.

Oil, grease, sand and suspended solids can impair transport and/or treatment efficiency through clogging and wear. Therefore, prevention and early removal of these substances is crucial for the durability of a treatment system. Pre-Treatment Technologies use physical removal mechanisms, such as screening, flotation, settling and filtration.

Behavioural and technical source control measures at the household or building level can reduce pollution loads and keep pre-treatment requirements low. For example, solid waste and cooking oil should be collected separately and not disposed of in sanitation systems. Equipping sinks, showers and the like with appropriate screens, filters and water seals can prevent solids from entering the system. Sewer inspection chambers

should always be closed with manhole covers to prevent extraneous material from entering the sewer.

Grease Trap The goal of the grease trap is to trap oil and grease so that it can be easily collected and removed. Grease traps are chambers made out of brickwork, concrete or plastic, with an odour-tight cover. Baffles or tees at the inlet and outlet prevent turbulence at the water surface and separate floating components from the effluent. A grease trap can either be located directly under the sink, or, for larger amounts of oil and grease, a bigger grease interceptor can be installed outdoors. An under-the-sink grease trap is relatively low cost, but must be cleaned frequently (once a week to once a month), whereas a larger grease interceptor has a higher capital cost, but is designed to be pumped out every 6 to 12 months. If designed to be large enough, grease traps can also remove grit and other settleable solids through sedimentation, similar to Septic Tanks (S.3).

Screen Screening aims to prevent coarse solids, such as plastics, rags and other trash, from entering a sewage system or treatment plant. Solids get

trapped by inclined screens or bar racks. The spacing between the bars usually is 15 to 40 mm, depending on cleaning patterns. Screens can be cleaned by hand or mechanically raked. The latter allows for more frequent solids removal and, correspondingly, a smaller design.

Grit Chamber Where subsequent treatment technologies could be hindered or damaged by the presence of sand, grit chambers (or sand traps) allow for the removal of heavy inorganic fractions by settling. There are three general types of grit chambers: horizontal-flow, aerated, or vortex chambers. All of these designs allow heavy grit particles to settle out, while lighter, principally organic particles remain in suspension.

Appropriateness Grease traps should be applied where considerable amounts of oil and grease are discharged. They can be installed at single households, restaurants or industrial sites. Grease removal is especially important where there is an immediate risk of clogging (e.g. a wetland for the treatment of greywater). Screening is essential where solid waste may enter a sewer system, as well as at the entrance of treatment plants. Trash traps, e.g. mesh boxes, can also be applied at strategic locations, such as market drains.

A grit chamber helps prevent sand deposits and abrasion in wastewater treatment plants, particularly, where roads are not paved and/or stormwater may enter the sewer system.

As laundries release high amounts of fabric fibres and particles with their wastewater, they should be equipped with lint trap devices.

Health Aspects/Acceptance The removal of solids and grease from pre-treatment technologies is not pleasant and, if households or community members are responsible for doing this, it may not be done regularly. Hiring professionals to do the removal may be the best option though it is costly. The people involved in the cleaning may come in contact with pathogens or toxic substances; therefore, adequately protecting oneself with safety clothes, i.e. boots and gloves, is essential.

Operation & Maintenance All pre-treatment products must be regularly monitored and cleaned to ensure proper functioning. If the maintenance frequency is too low, strong odours can result from the degradation of the accumulated material. Insufficiently maintained pre-treatment units can eventually lead to the failure of downstream elements of a sanitation system.

The pre-treatment products should be disposed of as solid waste in an environmentally sound way. In the case of grease, it may be used for energy production (e.g. biodiesel or co-digestion), or recycled for reuse.

Pros & Cons

- + Relatively low capital and operating costs
- + Reduced risk of impairing subsequent Conveyance and/or Treatment technologies
- + Higher lifetime and durability of sanitation hardware
- Frequent maintenance required
- The removal of solids and grease is not pleasant

References & Further Reading



can be found on page 244

Application Level:

- Household
 ** Neighbourhood
 ** City

Management Level:

- Household
 * Shared
 ** Public

Inputs:  Blackwater  Brownwater
 Greywater

Outputs:  Effluent  Sludge

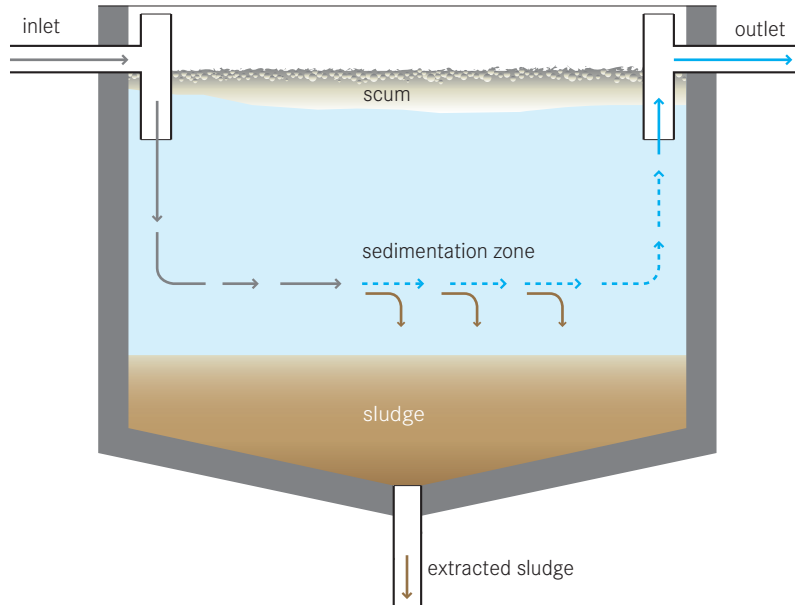

A Settler is a primary treatment technology for wastewater; it is designed to remove suspended solids by sedimentation. It may also be referred to as a sedimentation or settling basin/tank, or clarifier. The low flow velocity in a Settler allows settleable particles to sink to the bottom, while constituents lighter than water float to the surface.

Sedimentation is also used for the removal of grit (see PRE), for secondary clarification in Activated Sludge treatment (see T.13), after chemical coagulation/precipitation, or for sludge thickening. This technology information sheet discusses the use of Settlers as primary clarifiers, which are typically installed after a pre-treatment technology. Settlers can achieve a significant initial reduction in suspended solids (50-70% removal) and organic material (20-40% BOD removal) and ensure that these constituents do not impair subsequent treatment processes. Settlers may take a variety of forms, sometimes fulfilling additional functions. They can be independent tanks or integrated into combined treatment units. Several other technologies in this Compendium have a primary sedimentation function or include a compartment for

primary settling:

- the Septic Tank (S.3), where the low sludge removal frequency leads to anaerobic degradation of the sludge.
- the Anaerobic Baffled Reactor (S.4/T.3) and the Anaerobic Filter (S.5/T.4) both usually include a settler as the first compartment. However, the settler may also be built separately, e.g. in municipal treatment plants or in the case of prefabricated, modular units.
- the Biogas Reactor (T.18), which can be considered as a settler designed for anaerobic digestion and biogas production.
- the Imhoff Tank (T.2) and the Upflow Anaerobic Sludge Blanket Reactor (UASB, T.12), designed for the digestion of the settled sludge, prevent gases or sludge particles in the lower section from entering/returning to the upper section.
- the Waste Stabilisation Ponds (WSP, T.5), of which the first anaerobic pond is for settling
- the Sedimentation/Thickening Ponds (T.14), which are designed for the solid-liquid separation of faecal sludge
- the Solids-Free Sewer (C.4), which includes interceptor tanks at the building level.

Design Considerations The main purpose of a Settler is to facilitate sedimentation by reducing the velocity and turbulence of the wastewater stream. Settlers are circular or rectangular tanks that are typically designed for a hydraulic retention time of 1.5–2.5 h. Less time is needed if the BOD level should not be too low for the following biological step. The tank should be designed to ensure satisfactory performance at peak flow. In order to prevent eddy currents and short-circuiting, as well as to retain scum inside the basin, a good inlet and outlet construction with an efficient distribution and collection system (baffles, weirs or T-shaped pipes) is important.

Depending on the design, desludging can be done using a hand pump, airlift, vacuum pump, or by gravity using a bottom outlet. Large primary clarifiers are often equipped with mechanical collectors that continually scrape the settled solids towards a sludge hopper in the base of the tank, from where it is pumped to sludge treatment facilities. A sufficiently sloped tank bottom facilitates sludge removal. Scum removal can also be done either manually or by a collection mechanism.

The efficiency of the primary Settler depends on factors, such as wastewater characteristics, retention time and sludge withdrawal rate. It may be reduced by wind-induced circulation, thermal convection and density currents due to temperature differentials and, in hot climates, thermal stratification. These phenomena can lead to short-circuiting.

Several possibilities exist to enhance the performance of Settlers. Examples include the installation of inclined plates (lamellae) and tubes, which increase the settling area, or the use of chemical coagulants.

Appropriateness The choice of a technology to settle the solids is governed by the size and type of the installation, the wastewater strength, the management capacities and the desirability of an anaerobic process, with or without biogas production. Technologies that already include some type of primary sedimentation (listed above) do not need a separate Settler. Many

treatment technologies, however, require preliminary removal of solids in order to function properly. Although the installation of a primary sedimentation tank is often omitted in small activated sludge plants, it is of particular importance for technologies that use a filter material. Settlers can also be installed as stormwater retention tanks to remove a portion of the organic solids that otherwise would be directly discharged into the environment.

Health Aspects/Acceptance To prevent the release of odorous gases, frequent sludge removal is necessary. Sludge and scum must be handled with care as they contain high levels of pathogenic organisms; they require further treatment and adequate disposal. Appropriate protective clothing is necessary for workers who may come in contact with the effluent, scum or sludge.

Operation & Maintenance In Settlers that are not designed for anaerobic processes, regular sludge removal is necessary to prevent septic conditions and the build-up and release of gas which can hamper the sedimentation process by re-suspending part of the settled solids. Sludge transported to the surface by gas bubbles is difficult to remove and may pass to the next treatment stage.

Frequent scum removal and adequate treatment/disposal, either with the sludge or separately, is also important.

Pros & Cons

- + Simple and robust technology
- + Efficient removal of suspended solids
- + Relatively low capital and operating costs
- Frequent sludge removal
- Effluent, sludge and scum require further treatment
- Short-circuiting can be a problem

References & Further Reading

can be found on page 244

Application Level:

- Household
 * Neighbourhood
 ** City

Management Level:

- Household
 Shared
 ** Public

Inputs: Blackwater Brownwater
 Greywater

Outputs: Effluent Sludge

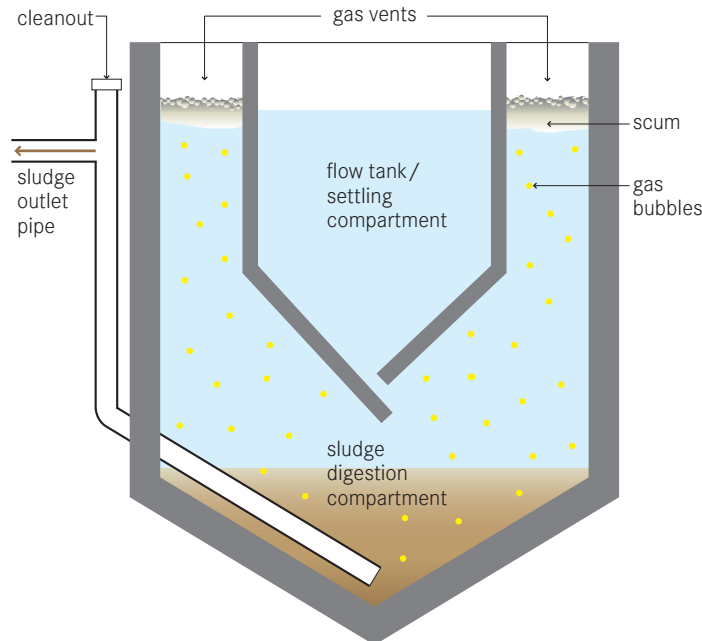

The Imhoff Tank is a primary treatment technology for raw wastewater, designed for solid-liquid separation and digestion of the settled sludge. It consists of a V-shaped settling compartment above a tapering sludge digestion chamber with gas vents.

The Imhoff tank is a robust and effective settler that causes a suspended solids reduction of 50 to 70%, COD reduction of 25 to 50% and leads to potentially good sludge stabilisation – depending on the design and conditions. The settling compartment has a circular or rectangular shape with V-shaped walls and a slot at the bottom, allowing solids to settle into the digestion compartment, while preventing foul gas from rising up and disturbing the settling process. Gas produced in the digestion chamber rises into the gas vents at the edge of the reactor. It transports sludge particles to the water surface, creating a scum layer. The sludge accumulates in the sludge digestion compartment and is compacted and partially stabilised through anaerobic digestion.

Design Considerations The Imhoff Tank is usually built underground with reinforced concrete. It can, however, also be built above ground, which makes sludge removal easier due to gravity, although it still requires pumping up of the influent. Small prefabricated Imhoff tanks are also available on the market. Hydraulic retention time is usually not more than 2 to 4 hours to preserve an aerobic effluent for further treatment or discharge. T-shaped pipes or baffles are used at the inlet and the outlet to reduce velocity and prevent scum from leaving the system. The total water depth in the tank from the bottom to the water surface may reach 7 to 9.5 m. The bottom of the settling compartment is typically sloped 1.25 to 1.75 vertical to 1 horizontal and the slot opening can be 150 to 300 mm wide. The walls of the sludge digestion compartment should have an inclination of 45° or more. This allows for the sludge to slide down to the centre where it can be removed. Dimensioning of the anaerobic digestion compartment depends mainly on sludge production per population equivalent, on the targeted degree of sludge stabilisation (linked to the desludging frequency) and the temperature. The digestion chamber is usually designed for 4 to 12 months sludge storage capacity

to allow for sufficient anaerobic digestion. In colder climates, longer sludge retention time and, therefore, a greater volume is needed. For desludging, a pipe and pump have to be installed or access provided for vacuum trucks and mobile pumps. A bar screen or grit chamber (see PRE, p. 76) is recommended before the Imhoff tank to prevent coarse material from disturbing the system.

Appropriateness Imhoff Tanks are recommended for domestic or mixed wastewater flows between 50 and 20,000 population equivalents. They are able to treat high organic loads and are resistant against organic shock loads. Space requirements are low. Imhoff Tanks can be used in warm and cold climates. As the tank is very high, it can be built underground if the groundwater table is low and the location is not flood prone.

Health Aspects/Acceptance As the effluent is almost odourless, it is a good option for primary treatment, if subsequent treatment takes place, e.g. in open ponds, constructed wetlands or trickling filters. Gases produced in low quantities may, however, generate odours locally. Pathogen removal is low and all outputs should be treated. Appropriate protective clothing is necessary for workers who may come in contact with the effluent, scum or sludge.

Operation & Maintenance Operation and maintenance are possible at low cost, if trained personnel are in charge. Flow paths have to be kept open and cleaned out weekly, while scum in the settling compartment and the gas vents has to be removed daily if necessary. Stabilised sludge from the bottom of the digestion compartment should be removed according to the design. A minimum clearance of 50 cm between the sludge blanket and the slot of the settling chamber has to be ensured at all times.

Pros & Cons

- + Solid-liquid separation and sludge stabilisation are combined in one single unit
- + Resistant against organic shock loads
- + Small land area required
- + The effluent is not septic (with low odour)
- + Low operating costs
- Very high (or deep) infrastructure; depth may be a problem in case of high groundwater table
- Requires expert design and construction
- Low reduction of pathogens
- Effluent, sludge and scum require further treatment

References & Further Reading

can be found on page 244

Application Level:

- * Household
- ** Neighbourhood
- City

Management Level:

- * Household
- ** Shared
- ** Public

Inputs: Effluent Blackwater
 Brownwater Greywater

Outputs: Effluent Sludge

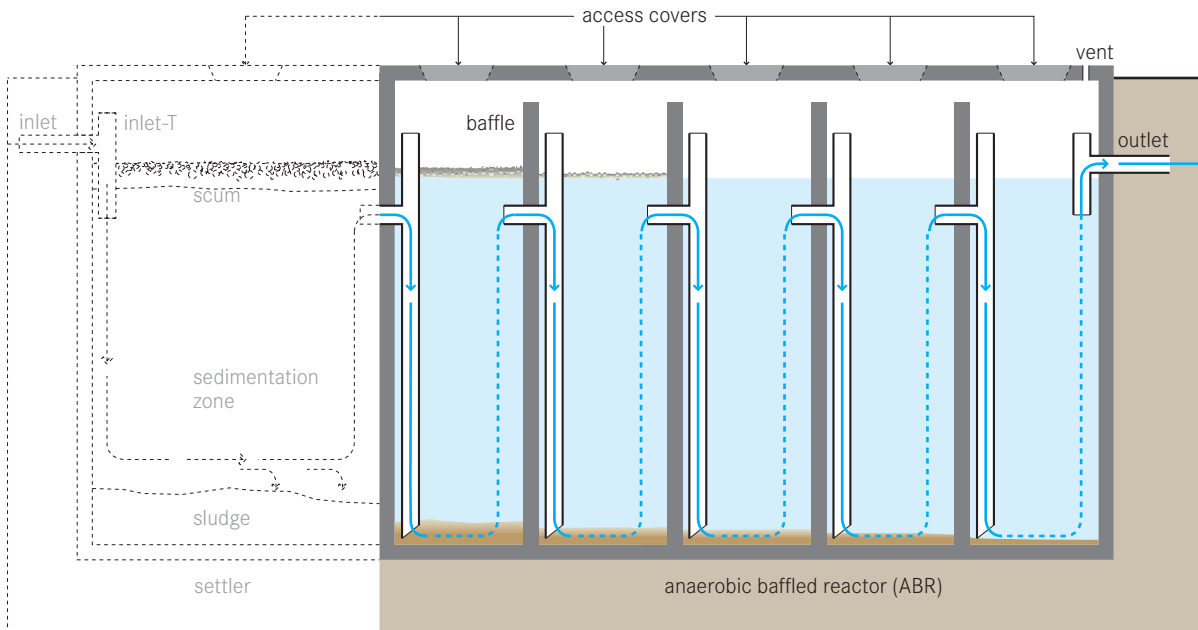

An Anaerobic Baffled Reactor (ABR) is an improved Septic Tank (S.3) with a series of baffles under which the wastewater is forced to flow. The increased contact time with the active biomass (sludge) results in improved treatment.

The upflow chambers provide enhanced removal and digestion of organic matter. BOD may be reduced by up to 90%, which is far superior to its removal in a conventional Septic Tank.

Design Considerations The majority of settleable solids are removed in a sedimentation chamber in front of the actual ABR. Small-scale, stand-alone units typically have an integrated settling compartment (as shown in S.4), but primary sedimentation can also take place in a separate Settler (T.1) or another preceding technology (e.g. existing Septic Tanks). Designs without a settling compartment are of particular interest for (Semi-) Centralised Treatment plants that combine the ABR with another technology for primary settling, or where prefabricated, modular units are used.

Typical inflows range from 2 to 200 m³ per day. Critical design parameters include a hydraulic retention time

(HRT) between 48 to 72 hours, upflow velocity of the wastewater below 0.6 m/h and the number of upflow chambers (3 to 6). The connection between the chambers can be designed either with vertical pipes or baffles. Accessibility to all chambers (through access ports) is necessary for maintenance. Usually, the biogas produced in an ABR through anaerobic digestion is not collected because of its insufficient amount. The tank should be vented to allow for controlled release of odorous and potentially harmful gases.

Appropriateness This technology is easily adaptable and can be applied at the household level, in small neighbourhoods or even in bigger catchment areas. It is most appropriate where a relatively constant amount of blackwater and greywater is generated. A (Semi-) Centralised ABR is appropriate when there is a pre-existing Conveyance technology, such as a Simplified Sewer (C.3). This technology is suitable for areas where land may be limited since the tank is most commonly installed underground and requires a small area. However, a vacuum truck should be able to access the location because the sludge must be regularly removed (particularly from the settler).

ABRs can be installed in every type of climate, although the efficiency is lower in colder climates where they are not efficient at removing nutrients and pathogens. The effluent usually requires further treatment.

Health Aspects/Acceptance Under normal operating conditions, users do not come in contact with the influent or effluent. Effluent, scum and sludge must be handled with care as they contain high levels of pathogenic organisms. The effluent contains odorous compounds that may have to be removed in a further polishing step. Care should be taken to design and locate the facility such that odours do not bother community members.

Operation & Maintenance An ABR requires a start-up period of several months to reach full treatment capacity since the slow growing anaerobic biomass first needs to be established in the reactor. To reduce start-up time, the ABR can be inoculated with anaerobic bacteria, e.g. by adding fresh cow dung or Septic Tank sludge. The added stock of active bacteria can then multiply and adapt to the incoming wastewater. Because of the delicate ecology, care should be taken not to discharge harsh chemicals into the ABR. Scum and sludge levels need to be monitored to ensure

that the tank is functioning well. Process operation in general is not required and maintenance is limited to the removal of accumulated sludge and scum every 1 to 3 years. This is best done by using a Motorised Emptying and Transport technology (C.2). The desludging frequency depends on the chosen pre-treatment steps, as well as on the design of the ABR. ABR tanks should be checked from time to time to ensure that they are watertight.

Pros & Cons

- + Resistant to organic and hydraulic shock loads
- + No electrical energy is required
- + Low operating costs
- + Long service life
- + High reduction of BOD
- + Low sludge production; the sludge is stabilised
- + Moderate area requirement (can be built underground)
- Requires expert design and construction
- Low reduction of pathogens and nutrients
- Effluent and sludge require further treatment and/or appropriate discharge

References & Further Reading

can be found on page 245

Application Level:

- * Household
- ** Neighbourhood
- City

Management Level:

- * Household
- ** Shared
- ** Public

Inputs:

- Effluent
- Blackwater
- Brownwater
- Greywater

Outputs:

- Effluent
- Sludge

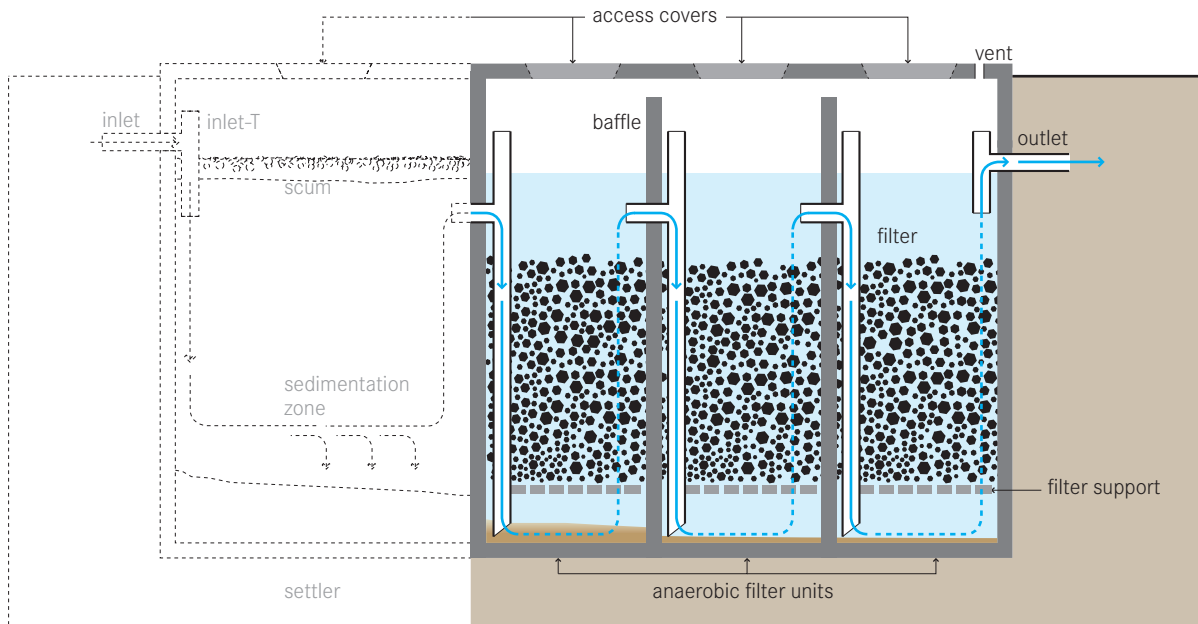

An Anaerobic Filter is a fixed-bed bioreactor with one or more filtration chambers in a series. As wastewater flows through the filter, particles are trapped and organic matter is degraded by the active biomass that is attached to the surface of the filter material.

With this technology, suspended solids and BOD removal can be as high as 90%, but is typically between 50% and 80%. Nitrogen removal is limited and normally does not exceed 15% in terms of total nitrogen (TN).

Design Considerations Pre- and primary treatment is essential to remove solids and garbage that may clog the filter. The majority of settleable solids are removed in a sedimentation chamber in front of the Anaerobic Filter. Small-scale, stand-alone units typically have an integrated settling compartment (as shown in S.5), but primary sedimentation can also take place in a separate Settler (T.1) or another preceding technology (e.g. existing Septic Tanks). Designs without a settling compartment are of particular interest for (Semi-) Centralised Treatment plants that combine the anaerobic filter with other technologies, such as the

Anaerobic Baffled Reactor (ABR, T.3). Anaerobic Filters are usually operated in upflow mode because there is less risk that the fixed biomass will be washed out. The water level should cover the filter media by at least 0.3 m to guarantee an even flow regime. The hydraulic retention time (HRT) is the most important design parameter influencing filter performance. An HRT of 12 to 36 hours is recommended. The ideal filter should have a large surface area for bacteria to grow, with pores large enough to prevent clogging. The surface area ensures increased contact between the organic matter and the attached biomass that effectively degrades it. Ideally, the material should provide between 90 to 300 m² of surface area per m³ of occupied reactor volume. Typical filter material sizes range from 12 to 55 mm in diameter. Materials commonly used include gravel, crushed rocks or bricks, cinder, pumice, or specially formed plastic pieces, depending on local availability. The connection between the chambers can be designed either with vertical pipes or baffles. Accessibility to all chambers (through access ports) is necessary for maintenance. The tank should be vented to allow for controlled release of odorous and potentially harmful gases.

Appropriateness This technology is easily adaptable and can be applied at the household level, in small neighbourhoods or even in bigger catchment areas. It is most appropriate where a relatively constant amount of blackwater and greywater is generated. The anaerobic filter can be used for secondary treatment, to reduce the organic loading rate for a subsequent aerobic treatment step, or for polishing.

This technology is suitable for areas where land may be limited since the tank is most commonly installed underground and requires a small area. Accessibility by vacuum trucks is important for desludging.

Anaerobic Filters can be installed in every type of climate, although the efficiency is lower in colder climates where they are not efficient at removing nutrients and pathogens. Depending on the filter material, however, complete removal of worm eggs may be achieved. The effluent usually requires further treatment.

Health Aspects/Acceptance Under normal operating conditions, users do not come in contact with the influent or effluent. Effluent, scum and sludge must be handled with care as they contain high levels of pathogenic organisms. The effluent contains odorous compounds that may have to be removed in a further polishing step. Care should be taken to design and locate the facility such that odours do not bother community members.

Operation & Maintenance An Anaerobic Filter requires a start-up period of 6 to 9 months to reach full treatment capacity since the slow growing anaerobic biomass first needs to be established on the filter media. To reduce start-up time, the filter can be inoculated with anaerobic bacteria, e.g. by spraying Septic Tank sludge

onto the filter material. The flow should be gradually increased over time. Because of the delicate ecology, care should be taken not to discharge harsh chemicals into the Anaerobic Filter.

Scum and sludge levels need to be monitored to ensure that the tank is functioning well. Over time, solids will clog the pores of the filter. As well, the growing bacterial mass will become too thick, break off and eventually clog pores. When the efficiency decreases, the filter must be cleaned. This is done by running the system in reverse mode (backwashing) or by removing and cleaning the filter material.

Anaerobic Filter tanks should be checked from time to time to ensure that they are watertight.

Pros & Cons

- + No electrical energy is required
- + Low operating costs
- + Long service life
- + High reduction of BOD and solids
- + Low sludge production; the sludge is stabilised
- + Moderate area requirement (can be built underground)
- Requires expert design and construction
- Low reduction of pathogens and nutrients
- Effluent and sludge require further treatment and/or appropriate discharge
- Risk of clogging, depending on pre- and primary treatment
- Removing and cleaning the clogged filter media is cumbersome

References & Further Reading





can be found on page 245

Application Level:

- Household
- Neighbourhood
- City

Management Level:

- Household
- Shared
- Public

Inputs:  Blackwater  Brownwater
 Greywater  Sludge

Outputs:  Effluent  Sludge

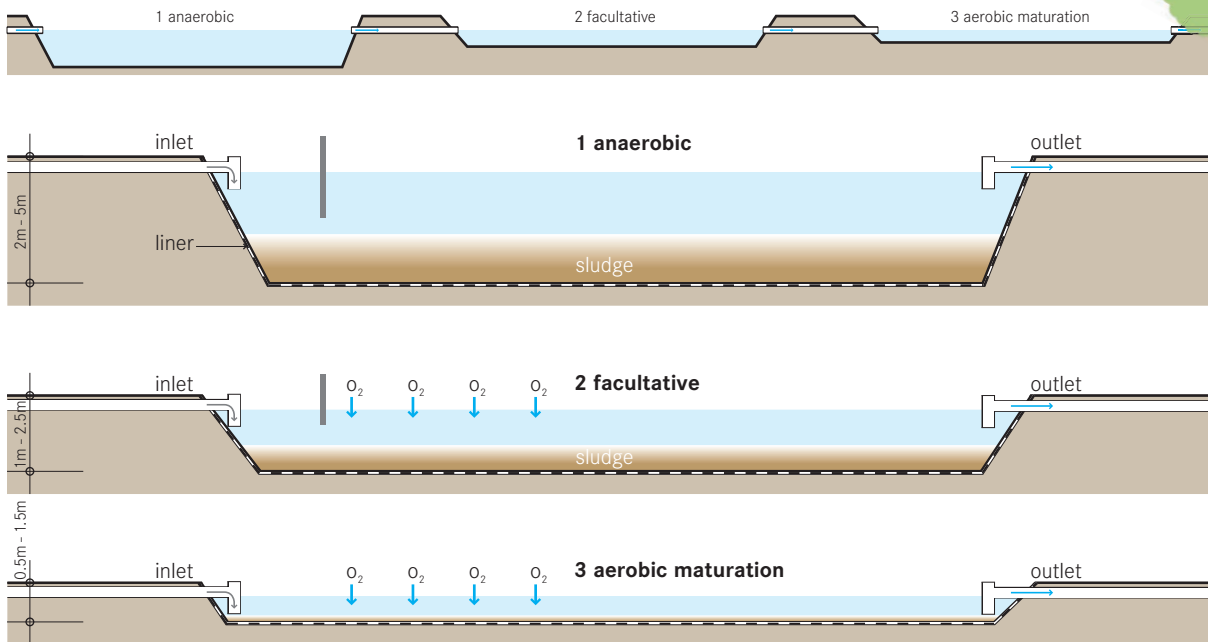

Waste Stabilisation Ponds (WSPs) are large, man-made water bodies. The ponds can be used individually, or linked in a series for improved treatment. There are three types of ponds, (1) anaerobic, (2) facultative and (3) aerobic (maturation), each with different treatment and design characteristics.

For the most effective treatment, WSPs should be linked in a series of three or more with effluent flowing from the anaerobic pond to the facultative pond and, finally, to the aerobic pond. The anaerobic pond is the primary treatment stage and reduces the organic load in the wastewater. The entire depth of this fairly deep pond is anaerobic. Solids and BOD removal occur by sedimentation and through subsequent anaerobic digestion inside the sludge. Anaerobic bacteria convert organic carbon into methane and, through this process, remove up to 60% of the BOD.

In a series of WSPs, the effluent from the anaerobic pond is transferred to the facultative pond, where further BOD is removed. The top layer of the pond receives oxygen from natural diffusion, wind mixing and algae-driven photosynthesis. The lower layer is deprived of oxygen and becomes anoxic or anaerobic. Settleable solids accumulate and are digested on the bottom of the pond. The aerobic and anaerobic organisms work together to achieve BOD reductions of up to 75%.

Anaerobic and facultative ponds are designed for BOD removal, while aerobic ponds are designed for pathogen removal. An aerobic pond is commonly referred to as a maturation, polishing, or finishing pond because it is usually the last step in a series of ponds and provides the final level of treatment. It is the shallowest of the ponds, ensuring that sunlight penetrates the full depth for photosynthesis to occur. Photosynthetic algae release oxygen into the water and at the same time consume carbon dioxide produced by the respiration of bacteria. Because photosynthesis is driven by sunlight, the dissolved oxygen levels are highest during the day and drop off at night. Dissolved oxygen is also provided by natural wind mixing.

Design Considerations Anaerobic ponds are built to a depth of 2 to 5 m and have a relatively short detention time of 1 to 7 days. Facultative ponds should be constructed to a depth of 1 to 2.5 m and have a detention time between 5 to 30 days. Aerobic ponds are usually between 0.5 to 1.5m deep. If used in combination with algae and/or fish harvesting (see R.7), this type of pond is effective at removing the majority of nitrogen and phosphorus from the effluent. Ideally, several aerobic ponds can be built in a series to provide a high level of pathogen removal.

Pre-Treatment (see PRE, p. 76) is essential to prevent scum formation and to hinder excess solids and garbage from entering the ponds. To prevent leaching into the groundwater, the ponds should have a liner. The liner can be made from clay, asphalt, compacted earth, or any other impervious material. To protect the pond from runoff and erosion, a protective berm should be constructed around the pond using the excavated material. A fence should be installed to ensure that people and animals stay out of the area and that garbage does not enter the ponds.

Appropriateness WSPs are among the most common and efficient methods of wastewater treatment around the world. They are especially appropriate for rural and periurban communities that have large, unused land where there is space to place them at a distance from homes and public spaces. They are not appropriate for very dense or urban areas.

Health Aspects/Acceptance Although effluent from aerobic ponds is generally low in pathogens, the ponds should in no way be used for recreation or as a direct source of water for consumption or domestic use

Operation & Maintenance Scum that builds up on the pond surface should be regularly removed. Aquatic plants (macrophytes) that are present in the pond should also be removed as they may provide a breeding habitat for mosquitoes and prevent light from penetrating the water column.

The anaerobic pond must be desludged approximately once every 2 to 5 years, when the accumulated solids reach one third of the pond volume. For facultative ponds, sludge removal is even rarer and maturation ponds hardly ever need desludging. Sludge can be removed by using a raft-mounted sludge pump, a mechanical scraper at the bottom of the pond or by draining and dewatering the pond and removing the sludge with a front-end loader.

Pros & Cons

- + Resistant to organic and hydraulic shock loads
- + High reduction of solids, BOD and pathogens
- + High nutrient removal if combined with aquaculture
- + Low operating costs
- + No electrical energy is required
- + No real problems with insects or odours if designed and maintained correctly
- Requires a large land area
- High capital costs depending on the price of land
- Requires expert design and construction
- Sludge requires proper removal and treatment

References & Further Reading

can be found on page 246

Application Level:

- Household
 Neighbourhood
 City

Management Level:

- Household
 Shared
 Public

Inputs: Effluent Blackwater
 Brownwater Greywater

Outputs: Effluent Sludge

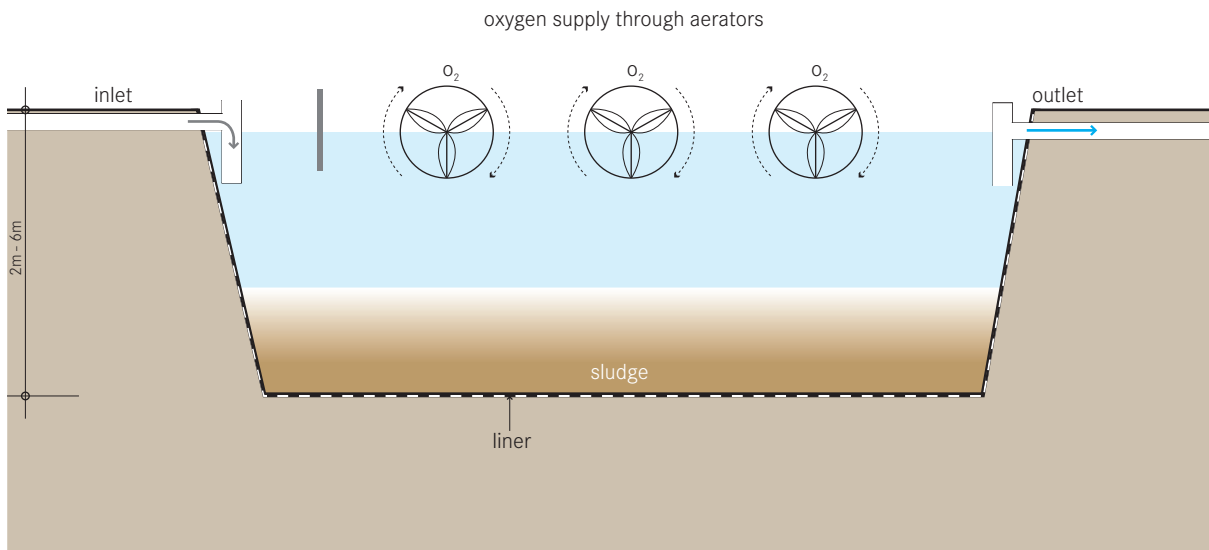

An Aerated Pond is a large, mixed, aerobic reactor. Mechanical aerators provide oxygen and keep the aerobic organisms suspended and mixed with water to achieve a high rate of organic degradation.

Increased mixing and aeration from the mechanical units mean that the ponds can be deeper and tolerate much higher organic loads than a maturation pond. The increased aeration allows for increased degradation and increased pathogen removal. Also, because oxygen is introduced by the mechanical units and not by light-driven photosynthesis, the ponds can function in more northern climates.

Design Considerations Influent should be screened and pre-treated to remove garbage and coarse particles that could interfere with the aerators. Because the aeration units mix the pond, a subsequent settling tank is required to separate the effluent from the solids. The pond should be built to a depth of 2 to 5 m and should have a detention time of 3 to 20 days, depending on the treatment target. To prevent leaching, the pond should have a liner. This can be made from clay, asphalt, compacted earth, or any other

impervious material. A protective berm should be built around the pond, using the fill that is excavated, to protect it from runoff and erosion.

Appropriateness A mechanically Aerated Pond can efficiently handle concentrated influent and significantly reduce pathogen levels. It is especially important that electricity service is uninterrupted and that replacement parts are available to prevent extended downtimes that may cause the pond to turn anaerobic. Aerated Ponds can be used in both rural and periurban environments. They are most appropriate for regions with large areas of inexpensive land located away from homes and businesses. Aerated lagoons can function in a larger range of climates than Waste Stabilisation Ponds (T.5) and the area requirement is smaller compared to a maturation pond.

Health Aspects/Acceptance The pond is a large expanse of pathogenic wastewater; care must be taken to ensure that no one comes in contact with or goes into the water. The aeration units can be dangerous to humans and animals. Fences, signage, or other measures should be taken to prevent entry into the area.

Operation & Maintenance Permanent, skilled staff is required to maintain and repair aeration machinery and the pond must be desludged every 2 to 5 years.

Care should be taken to ensure that the pond is not used as a garbage dump, especially considering the damage that could result to the aeration equipment.

Pros & Cons

- + Resistant to organic and hydraulic shock loads
- + High reduction of BOD and pathogens
- + No real problems with insects or odours if designed and maintained correctly
- Requires a large land area
- High energy consumption, a constant source of electricity is required
- High capital and operating costs depending on the price of land and of electricity
- Requires operation and maintenance by skilled personnel
- Not all parts and materials may be locally available
- Requires expert design and construction
- Sludge and possibly effluent require further treatment and/or appropriate discharge

References & Further Reading

can be found on page 246

Application Level:

★★ Neighbourhood

★★ City

Management Level:

★★ Shared

★★ Public

Inputs:  Effluent  Stormwater**Outputs:**  Effluent  Biomass

NBS

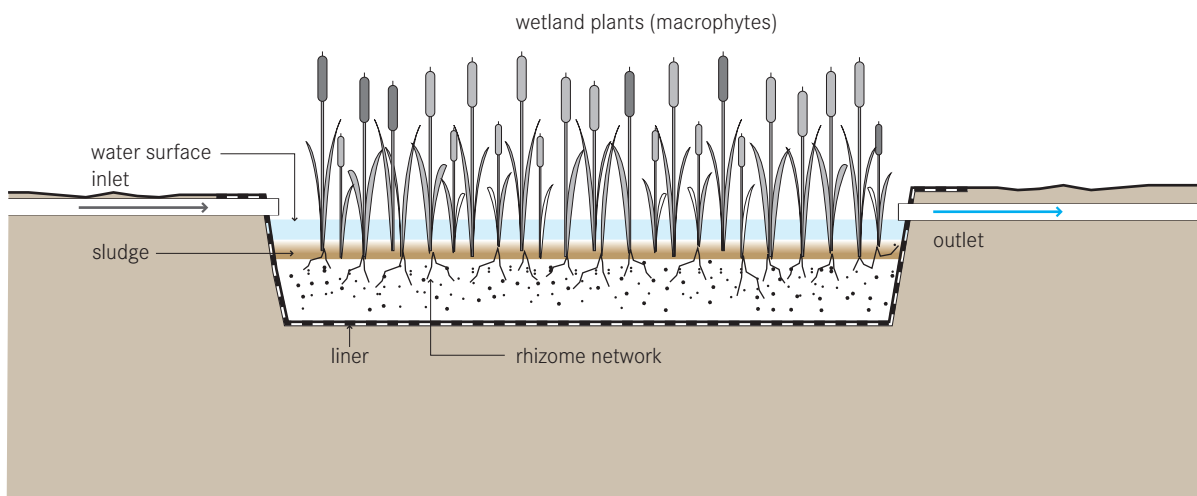

A Free-Water Surface Wetland aims to replicate the naturally occurring processes of a natural wetland, marsh or swamp. As water slowly flows through the wetland, particles settle, pathogens are destroyed and organisms and plants utilise the nutrients. This type of wetland is commonly used as an advanced treatment after secondary or tertiary treatment processes.

Unlike the Horizontal Flow Wetland (T.8), the Free-Water Surface Wetland allows for water to flow above ground exposed to the atmosphere and to direct sunlight. As the water slowly flows through the wetland, simultaneous physical, chemical and biological processes filter solids, degrade organics and remove nutrients from the wastewater.

Raw blackwater should be pre-treated to prevent the excess accumulation of solids and garbage. Once in the pond, the heavier sediment particles settle out and this also removes the nutrients attached to them. Plants and the communities of microorganisms that they support (on the stems and roots), take up nutrients, such as nitrogen and phosphorus. Chemical reactions

may cause other elements to precipitate out of the wastewater. Pathogens are removed from the water by natural decay, predation from higher organisms, sedimentation and UV irradiation.

Although the soil layer below the water is anaerobic, the plant roots exude (release) oxygen into the area immediately surrounding the root hairs, thus, creating an environment for complex biological and chemical activity.

Design Considerations The channel or basin is lined with an impermeable barrier (clay or geo-textile) covered with rocks, gravel and soil and planted with native vegetation (e.g. cattails, reeds and/or rushes). The wetland is flooded with wastewater to a depth of 10 to 45 cm above ground level. The wetland is compartmentalised into at least two independent flow paths. The number of compartments in series depends on the treatment target. The efficiency of the Free-Water Surface Wetland also depends on how well the water is distributed at the inlet. Wastewater can be fed into the wetland, using weirs or by drilling holes in a distribution pipe, to allow it to enter at evenly spaced intervals.

Appropriateness Free-water Surface Wetlands can achieve a high removal of suspended solids and moderate removal of pathogens, nutrients and other pollutants, such as heavy metals. This technology is able to tolerate variable water levels and nutrient loads. Plants limit the dissolved oxygen in the water from their shade and their buffering of the wind; therefore, this type of wetland is only appropriate for low-strength wastewater. This also makes it appropriate only when it follows some type of primary treatment to lower the BOD. Because of the potential for human exposure to pathogens, this technology is rarely used as secondary treatment. Typically, it is used for polishing effluent that has been through secondary treatment, or for stormwater retention and treatment.

The Free-Water Surface Wetland is a good option where land is cheap and available. Depending on the volume of the water and the corresponding area requirement of the wetland, it can be appropriate for small sections of urban areas, as well as for periurban and rural communities. This technology is best suited for warm climates, but can be designed to tolerate some freezing and periods of low biological activity.

Health Aspects/Acceptance The open surface can act as a potential breeding ground for mosquitoes. However, good design and maintenance can prevent this. Free-water surface wetlands are generally aesthetically pleasing, especially when they are integrated into pre-

existing natural areas. Care should be taken to prevent people from coming in contact with the effluent because of the potential for disease transmission and the risk of drowning in deep water.

Operation & Maintenance Regular maintenance should ensure that water is not short-circuiting, or backing up, because of fallen branches, garbage, or beaver dams blocking the wetland outlet. Vegetation may have to be periodically cut back or thinned out.

Pros & Cons

- + Aesthetically pleasing and provides animal habitat
- + High reduction of BOD and solids; moderate pathogen removal
- + Can be built and repaired with locally available materials
- + No electrical energy is required
- + No real problems with odours if designed and maintained correctly
- + Low operating costs
- May facilitate mosquito breeding
- Requires a large land area
- Long start-up time to work at full capacity
- Requires expert design and construction

References & Further Reading

can be found on page 246

Application Level:

- * Household
- ** Neighbourhood
- * City

Management Level:

- * Household
- ** Shared
- ** Public

Inputs: Effluent Wastewater
 Blackwater Brownwater Greywater

Outputs: Effluent Biomass

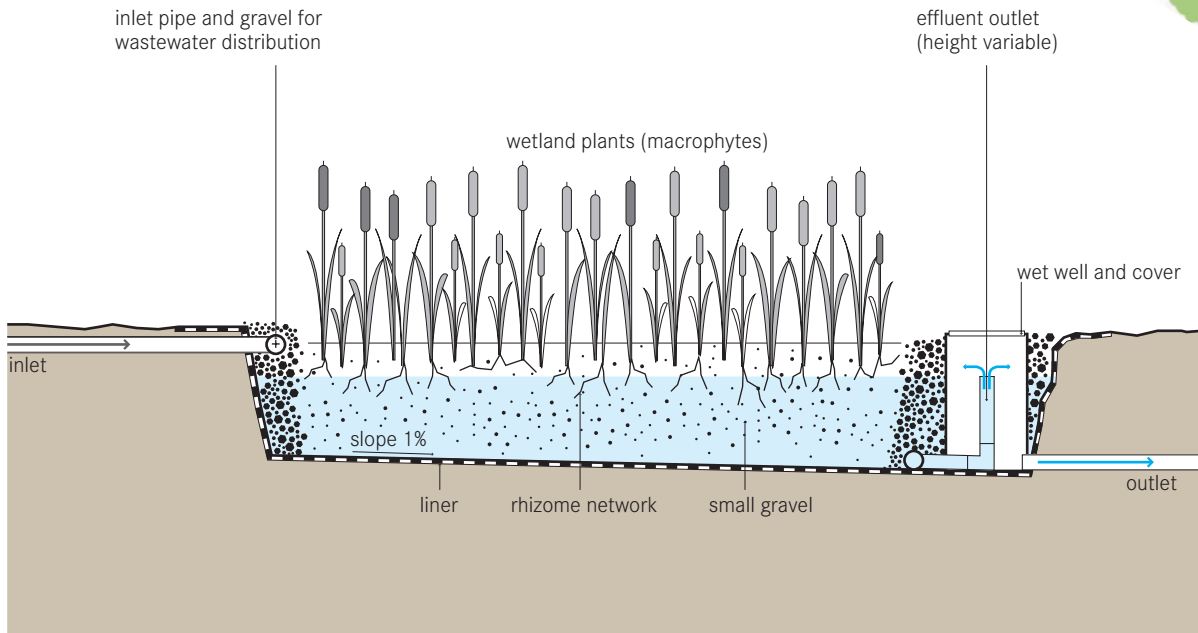

A Horizontal Flow Wetland is a large gravel and sand-filled basin that is planted with wetland vegetation. As wastewater flows horizontally through the basin, the filter material filters out particles and microorganisms degrade the organics.

The filter media acts as a filter for removing solids, a fixed surface upon which bacteria can attach and a base for the vegetation. Although facultative and anaerobic bacteria degrade most organics, the vegetation transfers a small amount of oxygen to the root zone so that aerobic bacteria can colonise the area and degrade organics as well. The plant roots play an important role in maintaining the permeability of the filter.

Design Considerations The design of a Horizontal Flow Wetland depends on the treatment target and the amount and quality of the influent. It includes decisions about the amount of parallel flow paths and compartmentation. The removal efficiency of the wetland is a function of the surface area (length multiplied by width), while the cross-sectional area (width multiplied by depth) determines the maximum possible flow. Generally, a surface area of about 5 to 10

m^2 per person equivalent is required. Pre- and primary treatment is essential to prevent clogging and ensure efficient treatment. The influent can be aerated by an inlet cascade to support oxygen-dependent processes, such as BOD reduction and nitrification.

The bed should be lined with an impermeable liner (clay or geotextile) to prevent leaching. It should be wide and shallow so that the flow path of the water in contact with vegetation roots is maximised. A wide inlet zone should be used to evenly distribute the flow. A well-designed inlet that allows for even distribution is important to prevent short-circuiting. The outlet should be variable so that the water surface can be adjusted to optimise treatment performance.

Small, round, evenly sized gravel (3 to 32 mm in diameter) is most commonly used to fill the bed to a depth of 0.5 to 1 m. To limit clogging, the gravel should be clean and free of fines. Sand is also acceptable, but is more prone to clogging than gravel. In recent years, alternative filter materials, such as PET, have been successfully used. The water level in the wetland is maintained at 5 to 15 cm below the surface to ensure subsurface flow. Any native plant with deep, wide roots that can grow in the wet, nutrient-rich environment is appropriate.

Phragmites australis (reed) is a common choice because it forms horizontal rhizomes that penetrate the entire filter depth.

Appropriateness Clogging is a common problem and, therefore, the influent has to be well settled with primary treatment before flowing into the wetland. This technology is not appropriate for untreated domestic wastewater (i.e. blackwater). It is a good treatment for communities that have primary treatment (e.g. Septic Tank, S.3), but are looking to achieve a higher quality effluent.

The Horizontal Flow Wetland is a good option where land is cheap and available. Depending on the volume of the water and the corresponding area requirement of the wetland, it can be appropriate for small sections of urban areas, as well as for periurban and rural communities. It can also be designed for single households.

This technology is best suited for warm climates, but it can be designed to tolerate some freezing and periods of low biological activity. If the effluent is to be reused, the losses due to high evapotranspiration rates could be a drawback of this technology, depending on the climate.

Health Aspects/Acceptance Significant pathogen removal is accomplished by natural decay, predation by higher organisms and filtration. As the water flows below the surface, any contact of pathogenic organisms with humans and wildlife is minimised. The risk of mosquito breeding is reduced since there is no standing water compared to the risk associated with Free-Water Surface Wetlands (T.7). The wetland is aesthetically pleasing and can be integrated into wild areas or parklands.

Operation & Maintenance During the first growing season, it is important to remove weeds that can compete with the planted wetland vegetation. With time, the gravel will become clogged from accumulated solids and bacterial film. The filter material at the inlet zone will require replacement every 10 or more years. Maintenance activities should focus on ensuring that primary treatment is effective at reducing the concentration of solids in the wastewater before it enters the wetland. Maintenance should also ensure that trees do not grow in the area as the roots can harm the liner.

Pros & Cons

- + High reduction of BOD, suspended solids and pathogens
- + Does not have the mosquito problems of the Free-Water Surface Wetland
- + No electrical energy is required
- + Low operating costs
- Requires a large land area
- Little nutrient removal
- Risk of clogging, depending on pre- and primary treatment
- Long start-up time to work at full capacity
- Requires expert design and construction

References & Further Reading

can be found on page 246

Application Level:

- * Household
- ** Neighbourhood
- ** City

Management Level:

- * Household
- * Shared
- ** Public

Inputs:

- Effluent
- Wastewater
- Blackwater
- Brownwater
- Greywater

Outputs:

- Effluent
- Biomass

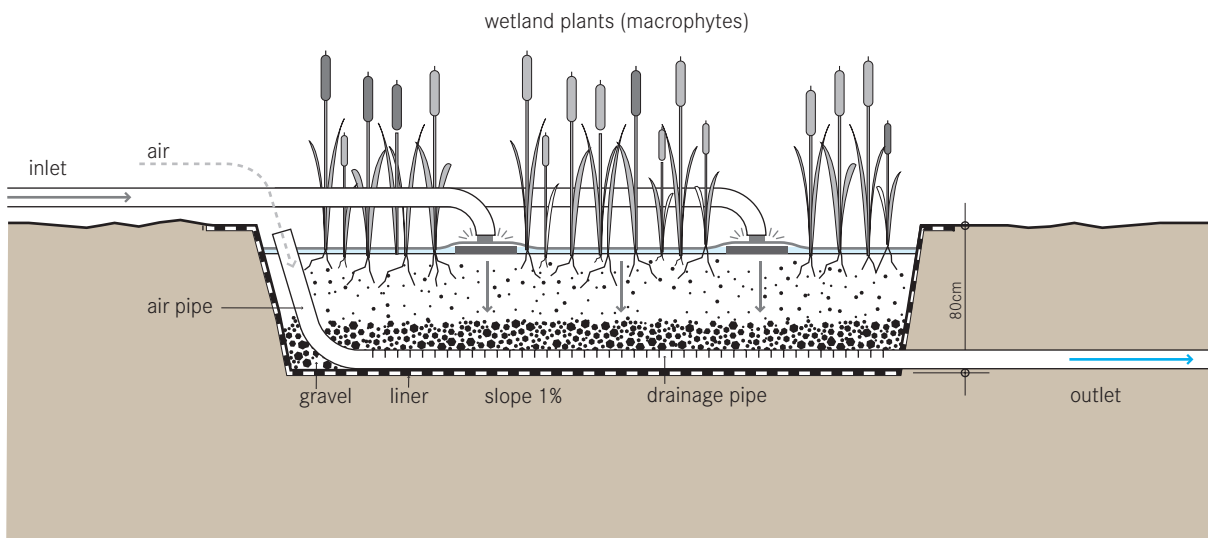

A Vertical Flow Wetland is a planted filter bed that is drained at the bottom. Wastewater is loaded intermittently onto the surface from above using a mechanical dosing system. The water flows vertically down through the filter matrix to the bottom of the basin where it is collected in a drainage pipe. The important difference between a vertical and horizontal wetland is not simply the direction of the flow path, but rather the aerobic conditions.

By intermittently dosing the wetland (4 to 10 times a day), the filter goes through stages of being saturated and unsaturated; and accordingly, different phases of aerobic and anaerobic conditions. During a flush phase, the wastewater percolates down through the unsaturated bed. As the bed drains, air is drawn into it and the oxygen has time to diffuse through the porous media.

The filter media acts as a filter for removing solids, a fixed surface upon which bacteria can attach and a base for the vegetation. The top layer is planted and the vegetation is allowed to develop deep, wide roots, which permeate the filter media. The vegetation

transfers a small amount of oxygen to the root zone so that aerobic bacteria can colonise the area and degrade organics. However, the primary role of vegetation is to maintain permeability in the filter and provide habitat for microorganisms. Nutrients and organic material are absorbed and degraded by the dense microbial populations. By forcing the organisms into a starvation phase between dosing phases, excessive biomass growth can be decreased and porosity increased.

Design Considerations The Vertical Flow Wetland can be designed as a shallow excavation or as an above ground construction. Clogging is a common problem. Therefore, the influent should be well settled in a primary treatment stage before flowing into the wetland. The design and size of the wetland is dependent on hydraulic and organic loads. Generally, a surface area of about 1 to 3 m² per person equivalent is required. Each filter should have an impermeable liner and an effluent collection system. A ventilation pipe connected to the drainage system can contribute to aerobic conditions in the filter. Structurally, there is a layer of gravel for drainage (a minimum of 20 cm), followed by layers of sand and gravel. Depending on the

climate, *Phragmites australis* (reed), *Typha* sp. (cattails) or *Echinochloa pyramidalis* are common plant options. Testing may be required to determine the suitability of locally available plants with the specific wastewater. Due to good oxygen transfer, vertical flow wetlands have the ability to nitrify, but denitrification is limited. In order to create a nitrification-denitrification treatment train, this technology can be combined with a Free-Water Surface or Horizontal Flow Wetland (T.7 and T.8).

Appropriateness The Vertical Flow Wetland is a good treatment for communities that have primary treatment (e.g. Septic Tanks, S.3), but are looking to achieve a higher quality effluent. Because of the mechanical dosing system, this technology is most appropriate where trained maintenance staff, constant power supply and spare parts are available. Since vertical flow constructed wetlands are able to nitrify, they can be an appropriate technology in the treatment process for wastewater with high ammonium concentrations. Vertical Flow Wetlands are best suited to warm climates, but can be designed to tolerate some freezing and periods of low biological activity.

Health Aspects/Acceptance Pathogen removal is accomplished by natural decay, predation by higher organisms and filtration. The risk of mosquito breeding is low since there is no standing water. The system is generally aesthetic and can be integrated into wild areas or parklands. Care should be taken to ensure that people do not come in contact with the influent because of the risk of infection.

Operation & Maintenance During the first growing season, it is important to remove weeds that can compete with the planted wetland vegetation.

Distribution pipes should be cleaned once a year to remove sludge and biofilm that might block the holes. With time, the gravel might become clogged by accumulated solids if the primary treatment is not operated well. Resting intervals may restore the hydraulic conductivity of the bed. If this does not help, the accumulated material has to be removed and clogged parts of the filter material replaced. Maintenance activities should focus on ensuring that primary treatment is effective at reducing the concentration of solids in the wastewater before it enters the wetland. Additionally, maintenance should also ensure that trees do not grow in the area as the roots can harm the liner.

Pros & Cons

- + High reduction of BOD, suspended solids and pathogens
- + Ability to nitrify due to good oxygen transfer
- + Does not have the mosquito problems of the Free-Water Surface Wetland
- + Requires less space than a Free-Water Surface or Horizontal Flow Wetland
- + Low operating costs
- Requires expert design and construction, particularly for the dosing system
- Risk of clogging, if primary treatment is not operated well
- Requires more frequent maintenance than a Horizontal Flow Wetland
- A constant source of electrical energy may be required (if elevation difference for loading with syphons is not available)
- Not all parts and materials may be locally available

References & Further Reading

can be found on page 247

Application Level:

** Neighbourhood

** City

Management Level:

** Shared

** Public

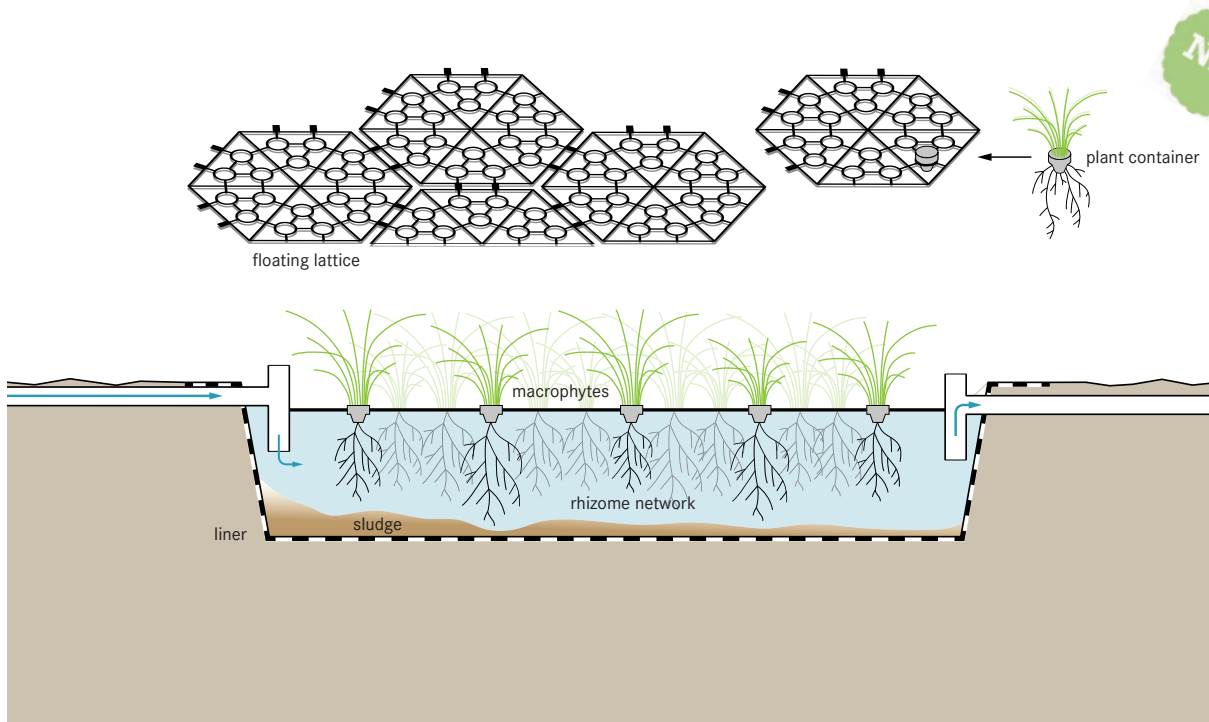
Inputs:  Effluent  Stormwater**Outputs:**  Effluent  Biomass  Sludge

In Floating Treatment Wetlands, also known as Floating Green Filters, the plants float on the surface of the pond or channel. The technology combines elements of phytoremediation and hydroponics. Macrophytes are used, which normally grow on the ground and develop their root system in the soil. Therefore, special floating devices are required, enabling the plants to remain on the water surface. These floating devices or lattices are made of lightweight polymers, such as polypropylene or other floating materials.

The rhizosphere of the plants (roots with their root hair system) is suspended in the water and serves as a microbially active site for sessile aerobic biofilm bacteria. The use of aerenchyma plants with spongy tissue enables the transport of oxygen from the atmosphere down to the roots, where they passively aerate the water and create favourable conditions for the growth of aerobic bacteria. Therefore, aerobic conditions prevail in the pond or channel down to the ends of the root system.

The flow of water through the dense root system with the biofilm causes an intense purification process,

which leads to a reduction of essential pollution parameters, such as BOD. Heavier sediment particles settle out, removing some of the nutrients attached to them. Further nutrient removal occurs through bacterial growth on the root system and uptake by plants, resulting in intensive plant growth.

Design Considerations As with other wetlands or ponds, the channel or pond must be lined with an impermeable barrier (geotextile is most commonly used) to prevent leaching into the groundwater. The depth of the channels or ponds varies from less than 1 m to up to more than 2 m. Water flow and flow rate are affected by settling of the sludge and sediments on the bottom. If the planned depth far exceeds the depth of the plant roots, a certain waterflow will bypass the root-zone, reducing the efficiency of the treatment. It is, therefore, necessary to calculate the appropriate depth accurately.

Depending on the size of the pond, good water distribution at the inlet can increase the efficiency. The feeding and distribution of the water can be done via weirs or via perforated pipes. A meandering channel can be an alternative to ponds to control water flow and

increase treatment efficiency. Aerenchyma plants, such as *Typha latifolia*, are often used for planting, which can be done in situ or onshore outside the water. It is also possible to create plant cover by successive planting as the floating devices are placed in the water. Proper attachment of the devices at the edges is required.

Appropriateness The dense root system has a high capacity to filter and retain suspended solids and a moderate to high capacity to remove nutrients and other pollutants, such as heavy metals. Depending on the retention time, the technology absorbs hydraulic peak loads and is tolerant of changes in flow rates. However, adequate protection against stormwater infiltration is necessary.

Macrophytes artificially floating on the surface of wetlands are a proper alternative to other nature-based treatment systems where the availability of land is the limiting factor. Depending on the volume of water to be treated and the area requirements, this kind of wetland can be appropriate for individual treatment systems, small urban and periurban clusters and rural communities.

Health Aspects/Acceptance With a well-integrated and pleasant design, the technology will upgrade its built environment. However, for safety reasons, it is less suitable as a recreational area. A dense and attentively maintained plant cover should also be developed because uncovered water surfaces are preferred breeding sites for mosquitoes.

Operation & Maintenance Regular cleaning of dead and fallen plant parts and periodic harvesting of biomass are essential maintenance tasks. Wetlands as channels simplify these tasks compared to ponds. Removal of sedimented sludge is necessary, with intervals depending on factors, such as the pre-treatment (e.g. sedimentation) and the depth of the channel or pond.

Pros & Cons

- + Aesthetically pleasing and a habitat for nature
- + High removal of BOD, suspended solids and nutrients
- + Removal of heavy metals
- + No electrical energy needed
- + Low operating cost
- + No odour problems with proper maintenance
- + Less space required compared to other Wetland systems
- Necessary time for root growth when establishing the plant cover
- Can encourage mosquito breeding if not properly maintained
- Requires a specialist for design and installation
- Requires special floating devices that can be difficult to obtain
- Lifetime not yet approved

References & Further Reading

can be found on page 247

Application Level:

- Household
 * Neighbourhood
 ** City

Management Level:

- Household
 Shared
 ** Public

Inputs: Effluent Blackwater
 Brownwater Greywater

Outputs: Effluent Sludge

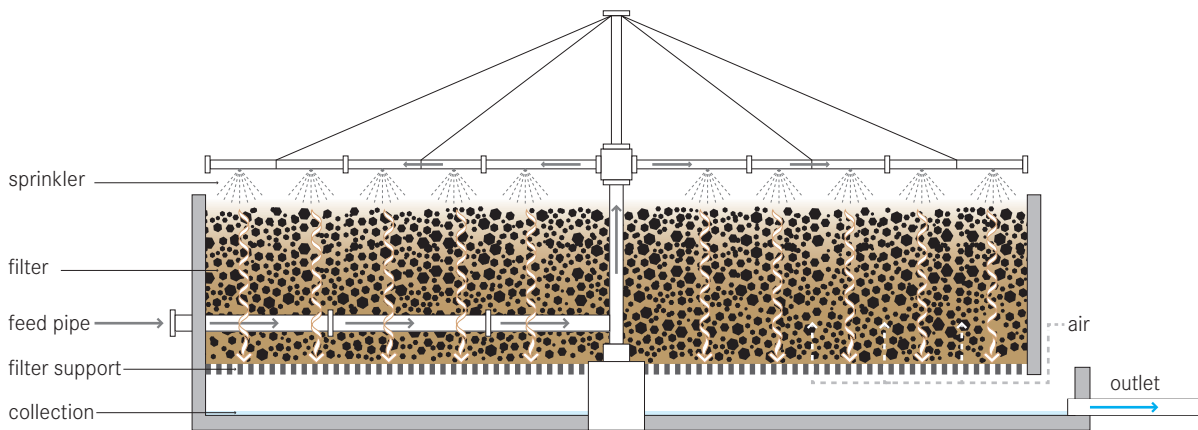

A Trickling Filter is a fixed-bed bio reactor that operates under (mostly) aerobic conditions. Pre-settled wastewater is continuously ‘trickled’ or sprayed over the filter. As the water migrates through the pores of the filter, organics are degraded by the biofilm covering the filter material.

The Trickling Filter is filled with a high specific surface area material, such as rocks, gravel, shredded PVC bottles, or special pre-formed plastic filter media. A high specific surface provides a large area for biofilm formation. Organisms that grow in the thin biofilm over the surface of the media oxidise the organic load in the wastewater to carbon dioxide and water, while generating new biomass.

The incoming pre-treated wastewater is ‘trickled’ over the filter, e.g. with the use of a rotating sprinkler. In this way, the filter media goes through cycles of being dosed and exposed to air. However, oxygen is depleted within the biomass and the inner layers may be anoxic or anaerobic.

Design Considerations The filter is usually 1 to 2.5 m deep, but filters packed with lighter plastic filling can be up to 12 m deep. The ideal filter material is low-cost and durable, has a high surface to volume ratio, is light and allows air to circulate. Whenever it is available, crushed rock or gravel is the cheapest option. The particles should be uniform and 95% of them should have a diameter between 7 and 10 cm. A material with a specific surface area between 45 and 60 m²/m³ for rocks and 90 to 150 m²/m³ for plastic packing is normally used. Larger pores (as in plastic packing) are less prone to clogging and provide for good air circulation. Primary treatment is also essential to prevent clogging and to ensure efficient treatment. Adequate air flow is important to ensure sufficient treatment performance and prevent odours. The underdrains should provide a passageway for air at the maximum filling rate. A perforated slab supports the bottom of the filter, allowing the effluent and excess sludge to be collected. The Trickling Filter is usually designed with a recirculation pattern for the effluent to improve wetting and flushing of the filter material. With time, the biomass will grow thick and the attached layer will be deprived of oxygen; it will enter an

endogenous state, will lose its ability to stay attached and will slough off. High-rate loading conditions will also cause sloughing. The collected effluent should be clarified in a settling tank to remove any biomass that may have dislodged from the filter. The hydraulic and nutrient loading rate (i.e. how much wastewater can be applied to the filter) is determined based on the characteristics of the wastewater, the type of filter media, the ambient temperature and the discharge requirements.

Appropriateness This technology can only be used following primary clarification since high solids loading will cause the filter to clog. A low-energy (gravity) trickling system can be designed, but in general, a continuous supply of power and wastewater is required. Compared to other technologies (e.g. Waste Stabilisation Ponds, T.5), Trickling Filters are compact, although they are still best suited for periurban or large, rural settlements.

Trickling Filters can be built in almost all environments, but special adaptations for cold climates are required.

Health Aspects/Acceptance Odour and fly problems require that the filter be built away from homes and businesses. Appropriate measures must be taken for pre- and primary treatment, effluent discharge and solids treatment, all of which can still pose health risks.

Operation & Maintenance A skilled operator is required to monitor the filter and repair the pump in case of problems. The sludge that accumulates on the filter

must be periodically washed away to prevent clogging and keep the biofilm thin and aerobic. High hydraulic loading rates (flushing doses) can be used to flush the filter. Optimum dosing rates and flushing frequency should be determined from the field operation.

The packing must be kept moist. This may be problematic at night when the water flow is reduced or when there are power failures.







Snails grazing on the biofilm and filter flies are well known problems associated with trickling filters and must be handled by backwashing and periodic flooding.

Pros & Cons

- + Can be operated at a range of organic and hydraulic loading rates
- + Efficient nitrification (ammonium oxidation)
- + Small land area required compared to constructed wetlands
- High capital costs
- Requires expert design and construction, particularly, the dosing system
- Requires operation and maintenance by skilled personnel
- Requires a constant source of electricity and constant wastewater flow
- Flies and odours are often problematic
- Risk of clogging, depending on pre- and primary treatment
- Not all parts and materials may be locally available

References & Further Reading

can be found on page 248

Application Level:	Management Level:	Inputs:  Blackwater  Brownwater
		(+  Greywater)
<input type="checkbox"/> Household	<input type="checkbox"/> Household	Outputs:  Effluent  Sludge  Biogas
<input checked="" type="checkbox"/> Neighbourhood	<input type="checkbox"/> Shared	
<input checked="" type="checkbox"/> City	<input checked="" type="checkbox"/> Public	

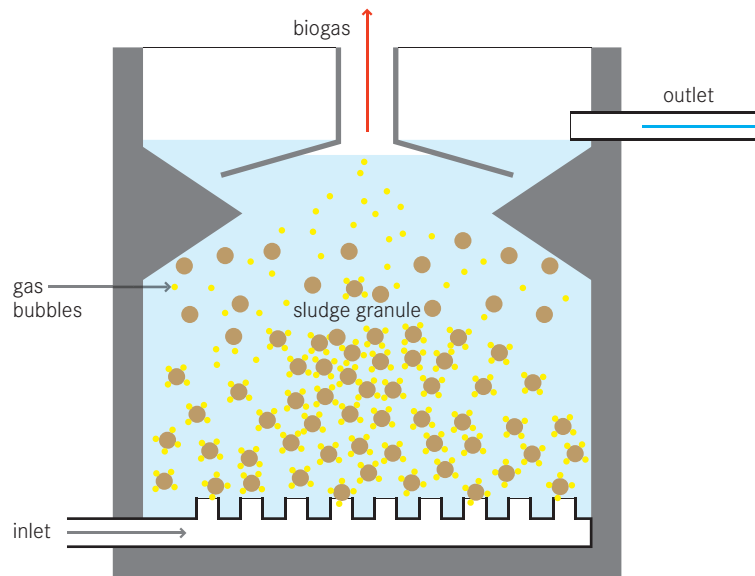

The Upflow Anaerobic Sludge Blanket Reactor (UASB) is a single tank process. Wastewater enters the reactor from the bottom and flows upward. A suspended sludge blanket filters and treats the wastewater as the wastewater flows through it.

The sludge blanket is comprised of microbial granules (1 to 3 mm in diameter), i.e. small agglomerations of microorganisms that, because of their weight, resist being washed out in the upflow. The microorganisms in the sludge layer degrade organic compounds. As a result, gases (methane and carbon dioxide) are released. The rising bubbles mix the sludge without the assistance of any mechanical parts. Sloped walls deflect material that reaches the top of the tank downwards. The clarified effluent is extracted from the top of the tank in an area above the sloped walls. After several weeks of use, larger granules of sludge form which, in turn, act as filters for smaller particles as the effluent rises through the cushion of sludge. Because of the upflow regime, granule-forming organisms are preferentially accumulated as the others are washed out.

Design Considerations Critical elements for the design of UASB reactors are the influent distribution system, the gas-solids separator and the effluent withdrawal design. The gas that rises to the top is collected in a gas collection dome and can be used as energy (biogas). An upflow velocity of 0.7 to 1 m/h must be maintained to keep the sludge blanket in suspension. Primary settling is usually not required before the UASB.

Appropriateness A UASB is not appropriate for small or rural communities without a constant water supply or electricity. The technology is relatively simple to design and build, but developing the granulated sludge may take several months. The UASB reactor has the potential to produce higher quality effluent than Septic Tanks (S.3) and can do so in a smaller reactor volume. Although it is a well-established process for large-scale industrial wastewater treatment and high organic loading rates up to 10 kg BOD/m³/d, its application to domestic sewage is still relatively new. It is often used for brewery, distillery, food processing and pulp and paper waste since the process typically removes 80 to 90% of COD.

Where the influent is low-strength or where it contains too many solids, proteins or fats, the reactor may not work properly. Temperature is also a key factor affecting the performance.

Health Aspects/Acceptance The operators should take proper health and safety measures while working in the plant, such as adequate protective clothing. Effluent and sludge still pose a health risk and should not be directly handled.

Operation & Maintenance The UASB is a Centralised Treatment technology that must be operated and maintained by professionals. A skilled operator is required to monitor the reactor and repair parts, e.g. pumps, in case of problems. Desludging is infrequent and only excess sludge is removed every 2 to 3 years.

Pros & Cons

- + High reduction of BOD
- + Can withstand high organic and hydraulic loading rates
- + Low sludge production (and, thus, infrequent desludging required)
- + Biogas can be used for energy (but usually first requires scrubbing)
- Treatment may be unstable with variable hydraulic and organic loads
- Requires operation and maintenance by skilled personnel; difficult to maintain proper hydraulic conditions (upflow and settling rates must be balanced)
- Long start-up time
- A constant source of electricity is required
- Not all parts and materials may be locally available
- Requires expert design and construction
- Effluent and sludge require further treatment and/or appropriate discharge

References & Further Reading

can be found on page 248

Application Level:

- Household
 Neighbourhood
 City

Management Level:

- Household
 Shared
 Public

Inputs: Effluent Blackwater
 Brownwater Greywater

Outputs: Effluent Sludge

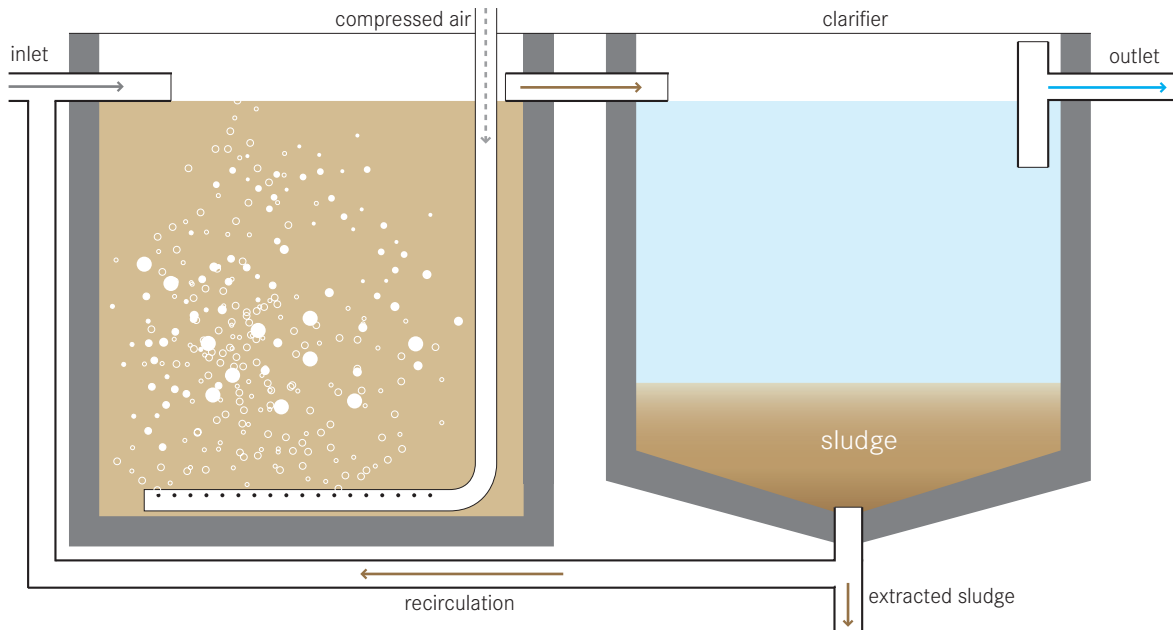

An Activated Sludge process refers to a multi-chamber reactor unit that makes use of highly concentrated microorganisms to degrade organics and remove nutrients from wastewater to produce a high-quality effluent. To maintain aerobic conditions and to keep the Activated Sludge suspended, a continuous and well-timed air supply (to provide oxygen) is required.

Different configurations of the activated sludge process can be employed to ensure that the wastewater is mixed and aerated in an aeration tank. Aeration and mixing can be provided by pumping air into the tank or by using surface aerators. The microorganisms oxidise the organic carbon in the wastewater to produce new cells, carbon dioxide and water. Although aerobic bacteria are the most common organisms, facultative bacteria along with higher organisms can be present. The exact composition depends on the reactor design, environment and wastewater characteristics.

The flocs (agglomerations of sludge particles), which form in the aerated tank, can be removed in the secondary clarifier by gravity settling. Some of this sludge is recycled from the clarifier back to the reactor.

The effluent can be discharged or treated in a tertiary treatment facility if necessary for further use.

Design Considerations Activated Sludge processes are one part of a complex treatment system. They are usually used after primary treatment (that removes settleable solids) and are sometimes followed by a final polishing step (see POST, p. 116). The biological processes that occur are effective at removing soluble, colloidal and particulate materials. The reactor can be designed for biological nitrification and denitrification, as well as for biological phosphorus removal.

The design must be based on an accurate estimation of the wastewater composition and volume. Treatment efficiency can be severely compromised if the plant is under- or over-dimensioned. Depending on the temperature, the solids retention time (SRT) in the reactor ranges from 3 to 5 days for BOD removal, to 3 to 18 days for nitrification.

The excess sludge requires treatment to reduce its water and organic content and to obtain a stabilised product suitable for end-use or final disposal. It is important to consider this step in the planning phase of the treatment plant.

To achieve specific effluent goals for BOD, nitrogen and phosphorus, different adaptations and modifications have been made to the basic activated sludge design. Well known modifications include sequencing batch reactors (SBR), oxidation ditches, extended aeration, moving beds, fixed films and membrane bioreactors.

If existing treatment plants using Activated Sludge technology need to be upgraded (higher load due to growing urbanisation or stricter discharge standards) and space is a constraint, retrofitting existing tanks with SAFF modules (or MBBR as presented in S.6) may be considered. These processes - while still part of the activated sludge technology - allow for a higher active biomass per volume, due to their high surface area for attached growth of microorganisms. This leads to higher treatment performance compared to conventional activated sludge processes based on suspended growth of microorganisms in the aerated water. As explained in S.6, MBR's may equally be suited to upgrade the performance of existing wastewater treatment plants due to the functionality of their membrane.

Appropriateness An Activated Sludge process is only appropriate for a Centralised Treatment facility with a well-trained staff, constant electricity and a highly developed management system that ensures that the facility is correctly operated and maintained.

Because of economies of scale and less fluctuating influent characteristics, this technology is more effective for the treatment of large volumes of flows.

An Activated Sludge process is appropriate in almost every climate. However, treatment capacity is reduced in colder environments.

Health Aspects/Acceptance Because of space requirements and odours, Centralised Treatment facilities are generally located in the periphery of densely

populated areas. Although the effluent produced is of high quality, it still poses a health risk and should not be directly handled. In the excess sludge, pathogens are substantially reduced, but not eliminated.



Operation & Maintenance Highly trained staff are required for maintenance and trouble-shooting. The mechanical equipment (mixers, aerators and pumps) must be constantly maintained. Also, the influent and effluent must be constantly monitored and the control parameters adjusted, if necessary, to avoid abnormalities that could kill the active biomass and the development of detrimental organisms that could impair the process (e.g. filamentous bacteria).

Pros & Cons

- + Resistant to organic and hydraulic shock loads
- + Can be operated at a range of organic and hydraulic loading rates
- + High reduction of BOD and pathogens (up to 99%)
- + High nutrient removal possible
- + Can be modified to meet specific discharge limits
- High energy consumption, a constant source of electricity is required
- High capital and operating costs
- Requires operation and maintenance by skilled personnel
- Prone to complicated chemical and microbiological problems
- Not all parts and materials may be locally available
- Requires expert design and construction
- Sludge and possibly effluent require further treatment and/or appropriate discharge

References & Further Reading

can be found on page 248

Application Level:	Management Level:	Inputs:  Sludge
<input type="checkbox"/> Household	<input type="checkbox"/> Household	Outputs:  Sludge  Effluent
<input checked="" type="checkbox"/> Neighbourhood	<input type="checkbox"/> Shared	
<input checked="" type="checkbox"/> City	<input checked="" type="checkbox"/> Public	

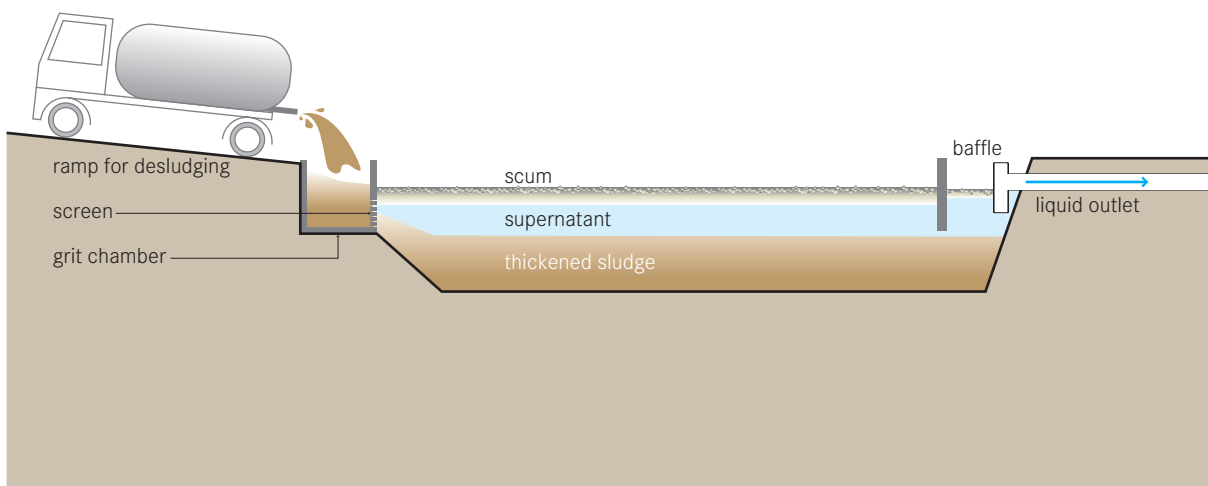

Sedimentation or Thickening Ponds are settling ponds that allow sludge to thicken and dewater. The effluent is removed and treated, while the thickened sludge can be further treated in a subsequent technology.

Faecal sludge is not a uniform product and, therefore, its treatment must be specific to the characteristics of the sludge. Sludge, which is still rich in organics and has not undergone significant degradation, is difficult to dewater. Conversely, sludge that has undergone significant anaerobic degradation, is more easily dewatered.

In order to be properly dried, fresh sludge rich in organic matter (e.g. latrine or public toilet sludge) must first be stabilised. Allowing the sludge to degrade anaerobically in Sedimentation/Thickening Ponds can do this. The same type of pond can be used to thicken sludge which is already partially stabilised (e.g. originating from Septic Tanks, S.3), although it undergoes less degradation and requires more time to settle. The degradation process may actually hinder the settling of sludge because the gases produced bubble up and re-suspend the solids.

As the sludge settles and digests, the supernatant must be decanted and treated separately. The thickened sludge can then be dried or further composted.

Design Considerations Two tanks operating in parallel are required; one can be operated, while the other is emptied. To achieve maximum efficiency, loading and resting periods should not exceed 4 to 5 weeks, although much longer cycles are common. When a 4-week loading and 4-week resting cycle is used, total solids (TS) can be increased to 14% (depending on the initial concentration).

Appropriateness Sedimentation/Thickening Ponds are appropriate where there is inexpensive, available space located far from homes and businesses; they should be established at the border of the community. The thickened sludge is still infectious, although it is easier to handle and less prone to splashing and spraying. Trained staff for operation and maintenance is required to ensure proper functioning.

This is a low-cost option that can be installed in most hot and temperate climates. Excessive rain may prevent the sludge from properly settling and thickening.

Health Aspects/Acceptance Both the incoming and thickened sludge are pathogenic; therefore, workers should be equipped with proper protection (boots, gloves and clothing). The thickened sludge is not sanitised and requires further treatment (at least in a drying process) before Reuse or Disposal.

The ponds may cause a nuisance for nearby residents due to bad odours and the presence of flies. Thus, they should be located sufficiently away from residential areas.

Operation & Maintenance Maintenance is an important aspect of well-functioning ponds, but it is not intensive. The discharging area must be maintained and kept clean to reduce the potential of disease transmission and nuisance (flies and odours). Solid waste that is discharged along with the sludge must be removed from the screen at the inlet of the ponds.



The thickened sludge must be mechanically removed (with a front end loader or other specialised equipment) after it has sufficiently thickened.

Pros & Cons

- + Thickened sludge is easier to handle and less prone to splashing and spraying
- + Can be built and repaired with locally available materials
- + Relatively low capital costs; low operating costs
- + No electrical energy is required
- Requires a large land area
- Odours and flies are normally noticeable
- Long storage times
- Requires front-end loader for desludging
- Requires expert design and construction
- Effluent and sludge require further treatment

References & Further Reading

can be found on page 248

Application Level:	Management Level:	Inputs:  Sludge
<input type="checkbox"/> Household	<input type="checkbox"/> Household	Outputs:  Sludge  Effluent
<input checked="" type="checkbox"/> Neighbourhood	<input type="checkbox"/> Shared	
<input checked="" type="checkbox"/> City	<input checked="" type="checkbox"/> Public	

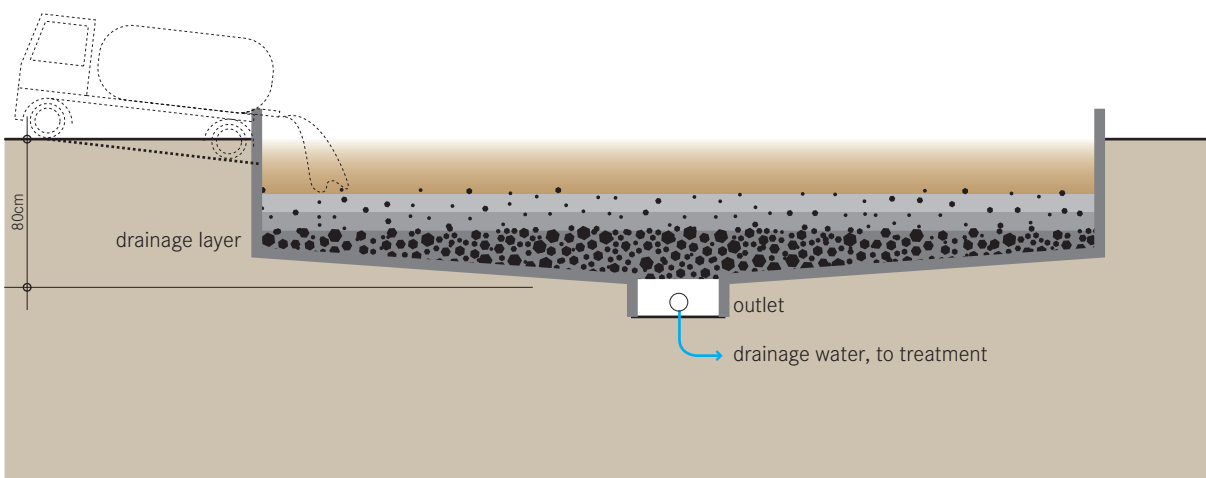

An Unplanted Drying Bed is a simple, permeable bed that, when loaded with sludge, collects percolated leachate and allows the sludge to dry by evaporation. Approximately 50% to 80% of the sludge volume drains off as liquid or evaporates. The sludge, however, is not effectively stabilised or sanitised.

The bottom of the Unplanted Drying Bed is lined with perforated pipe to drain the leachate away that percolates through the bed. On top of the pipes are layers of gravel and sand that support the sludge and allow for the liquid to infiltrate and collect in the pipe. It should not be applied in layers that are too thick (maximum 20 cm), or the sludge will not dry effectively. The final moisture content after 10 to 15 days of drying should be approximately 60%. When the sludge is dried, it must be separated from the sand layer and transported for further treatment, end-use or final disposal. The leachate that is collected in the drainage pipes must also be treated properly, depending on where it is discharged.

Design Considerations The drainage pipes are covered by 3-5 graded layers of gravel and sand. The bottom layer should be coarse gravel and the top fine sand (0.1 to 0.5 mm effective grain size). The top sand layer should be 250 to 300 mm thick because some sand will be lost each time the sludge is removed.

To improve drying and percolation, sludge application can alternate between two or more beds. The inlet should be equipped with a splash plate to prevent erosion of the sand layer and to allow for even distribution of the sludge.

Designing Unplanted Drying Beds has to consider future maintenance because ensuring access to people and trucks for pumping in the sludge and removing the dried sludge is essential.

If installed in wet climates, the facility should be covered by a roof and special caution should be given to prevent the inflow of surface runoff.

Appropriateness Sludge drying is an effective way to decrease the volume of sludge, which is especially important when it has to be transported elsewhere for further treatment, end-use or disposal. The technology is not effective at stabilising the organic fraction or

decreasing the pathogenic content. Further storage or treatment (e.g. Co-Composting, T.17) of the dried sludge might be required.

Unplanted Drying Beds are appropriate for small to medium communities with populations up to 100 000 people, but larger ones also exist for huge urban agglomerations. They are best suited for rural and periurban areas where there is inexpensive, available space situated far from homes and businesses. If designed to service urban areas, Unplanted Drying Beds should be at the border of the community, but within economic reach of Motorised Emptying operators.

This is a low-cost option that can be installed in most hot and temperate climates. Excessive rain may prevent the sludge from properly drying.

Health Aspects/Acceptance Both the incoming and dried sludge are pathogenic; therefore, workers should be equipped with proper protection (boots, gloves and clothing). The dried sludge and effluent are not sanitised and may require further treatment or storage, depending on the desired end-use.

The drying bed may cause a nuisance for nearby residents due to bad odours and the presence of flies. Thus, it should be located sufficiently away from residential areas.

Operation & Maintenance Trained staff for operation and maintenance is required to ensure proper functioning.

Dried sludge can be removed after 10 to 15 days, but this depends on the climate conditions. Because some sand is lost with every removal of sludge, the top layer must be replaced when it gets thin. The discharge area must be kept clean and the effluent drains should be regularly flushed.

Pros & Cons

- + Good dewatering efficiency, especially in dry and hot climates
- + Can be built and repaired with locally available materials
- + Relatively low capital costs; low operating costs
- + Simple operation, only infrequent attention required
- + No electrical energy is required
- Requires a large land area
- Odours and flies are normally noticeable
- Labour intensive removal
- Limited stabilisation and pathogen reduction
- Requires expert design and construction
- Leachate requires further treatment

References & Further Reading

can be found on page 249

Application Level:

- Household
 * Neighbourhood
 ** City

Management Level:

- Household
 Shared
 ** Public

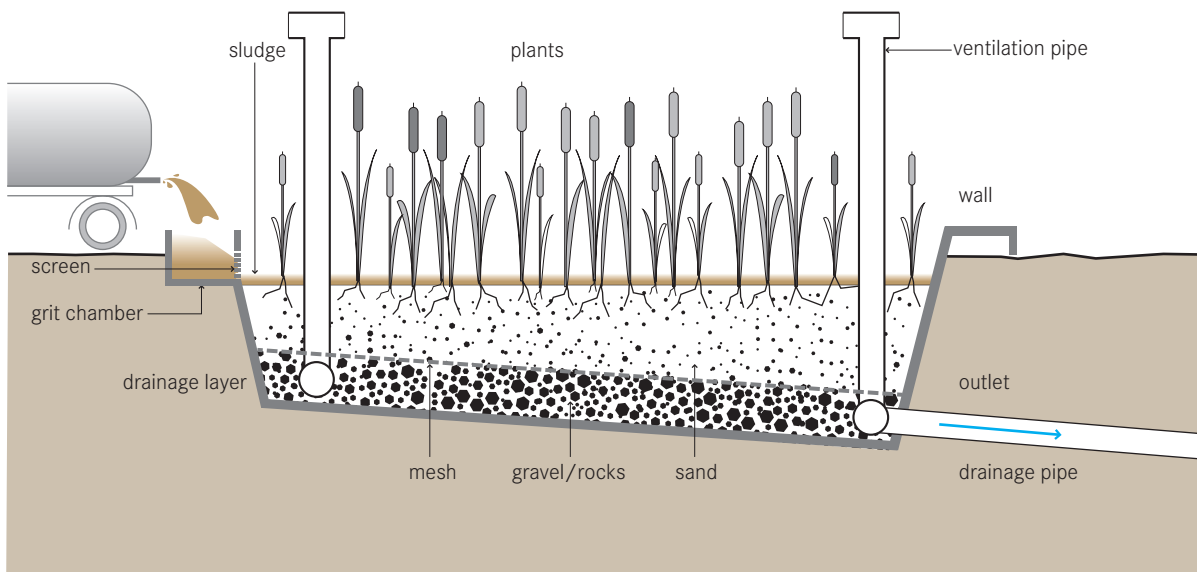
Inputs:  Sludge**Outputs:**  Sludge  Effluent  Biomass

A **Planted Drying Bed** is similar to an **Unplanted Drying Bed (T.15)**, but has the added benefit of **transpiration and enhanced sludge treatment due to the plants**. The key improvement of the planted bed over the unplanted bed is that the filters do not need to be desludged after each feeding/drying cycle. Fresh sludge can be directly applied onto the previous layer; the plants and their root systems maintain the porosity of the filter.

This technology has the benefit of dewatering and stabilising the sludge. Also, the roots of the plants create pathways through the thickening sludge that allow water to easily escape.

The appearance of the bed is similar to a Vertical Flow Wetland (T.9). The beds are filled with sand and gravel to support the vegetation. Instead of effluent, sludge is applied to the surface and the filtrate flows down through the subsurface where it is collected in drains.

Design Considerations Ventilation pipes connected to the drainage system contribute to aerobic conditions in the filter. A general design for layering the bed is: (1) 250 mm of coarse gravel (grain diameter of

20 mm); (2) 250 mm of fine gravel (grain diameter of 5 mm); and (3) 100 to 150 mm of sand. Free space (1 m) should be left above the top of the sand layer to account for about 3 to 5 years of accumulation.

Reeds (*Phragmites* sp.), cattails (*Typha* sp.) antelope grass (*Echinochloa* sp.) and papyrus (*Cyperus papyrus*) are suitable plants, depending on the climate. Local, non-invasive species can be used if they grow in humid environments, are resistant to salty water and readily reproduce after cutting.

Sludge should be applied in layers between 75 to 100 mm thick and reapplied every 3 to 7 days, depending on the sludge characteristics, the environment and operating constraints. Sludge application rates of 100 to 250 kg/m²/year have been reported in warm tropical climates. In colder climates, such as northern Europe, rates up to 80 kg/m²/year are typical. Two or more parallel beds can be alternately used to allow for sufficient degradation and pathogen reduction of the top layer of sludge before it is removed.

The leachate that is collected in the drainage pipes must be treated properly, depending on where it is discharged.

Appropriateness This technology is effective at decreasing the sludge volume (down to 50%) through decomposition and drying, which is especially important when the sludge needs to be transported elsewhere for end-use or disposal.

Because of their area requirements, Planted Drying Beds are most appropriate for small to medium communities with populations up to 100 000 people, but they can also be used in bigger cities. If designed to service urban areas, Planted Drying Beds should be at the border of the community, but within economic reach of Motorised Emptying operators.

Health Aspects/Acceptance Because of the pleasing aesthetics, there should be few problems with acceptance, especially if located sufficiently away from dense housing. Undisturbed plantations can attract wildlife, including poisonous snakes.

Faecal sludge is hazardous and anyone working with it should wear protective clothing, boots and gloves. The degree of pathogen reduction in the sludge will vary with the climate. Depending on the desired end-use, further storage and drying might be required.

Operation & Maintenance Trained staff for operation and maintenance is required to ensure proper functioning. The drains must be maintained and the effluent properly collected and disposed of. The plants should have grown sufficiently before applying the sludge. The acclimation phase is crucial and requires much care. The plants should be periodically thinned and/or harvested. After 3 to 5 years, the sludge can be removed.

Pros & Cons

- + Can handle high loading
- + Better sludge treatment than in Unplanted Drying Beds
- + Can be built and repaired with locally available materials
- + Relatively low capital costs; low operating costs
- + Fruit or forage growing in the beds can generate income
- + No electrical energy required
- Requires a large land area
- Odours and flies may be noticeable
- Long storage times
- Labour intensive removal
- Requires expert design and construction
- Leachate requires further treatment

References & Further Reading



can be found on page 249

Application Level:

- Household
 Neighbourhood
 City

Management Level:

- Household
 Shared
 Public

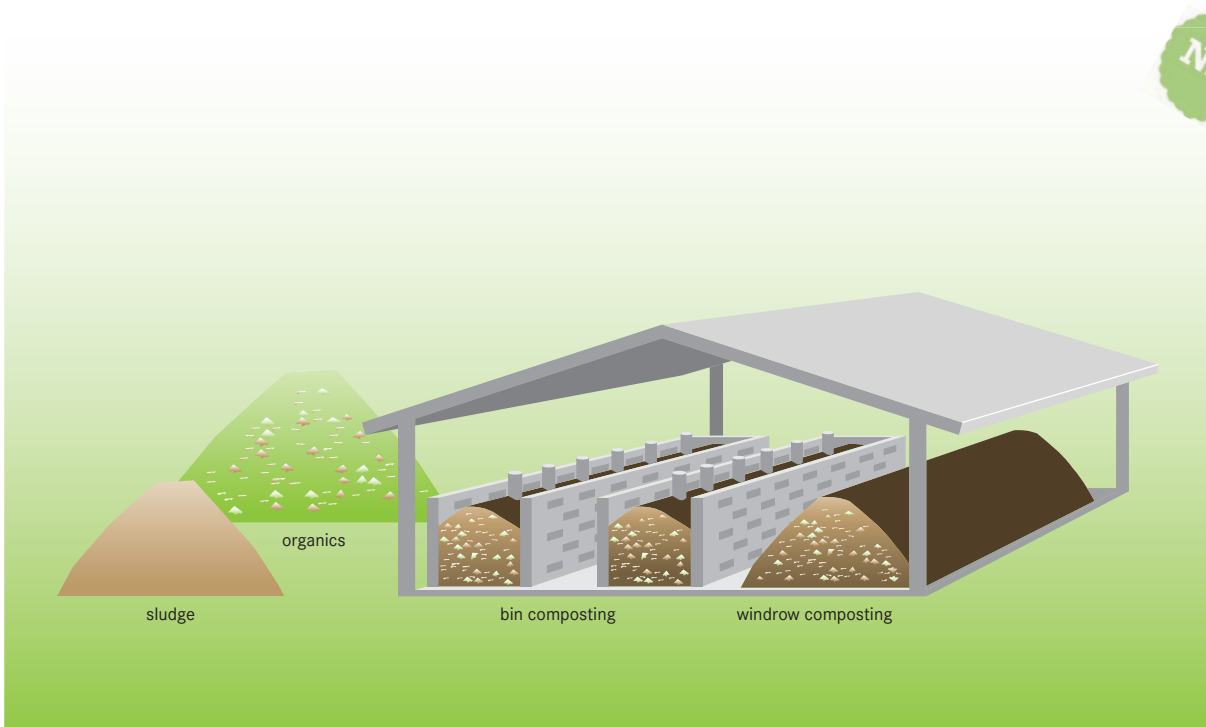
Inputs:  Sludge  Organics**Outputs:**  Compost

Co-Composting is the controlled aerobic degradation of organics, using more than one feedstock (faecal sludge and organic solid waste). Faecal sludge has a high moisture and nitrogen content, while biodegradable solid waste is high in organic carbon and has good bulking properties (i.e. it allows air to flow and circulate). By combining the two, the benefits of each contribute to optimise the process and the end-product.

In the composting process, microorganisms degrade the organic material in an aerobic ambient into compost, a humus rich material. Beside the need of oxygen or aeration, other factors control the microbiological activity, namely the substrate moisture, temperature, pH and the C:N ratio of the composting material. In the first weeks of the aerobic decomposition process (thermophilic phase), the compost can heat up to 65°C, while the temperature decreases over several weeks in the maturation phase, resulting after about 6 to 12 months in “compost”, a valuable and commercially viable end product. A balanced moisture content that prevents drying (< 45% moisture content) or supersaturation (> 60%) is conducive to the decomposition and a C:N ratio of 25-35:1 is optimal for the composting process.

Design Considerations There are different types of composting designs: the most commonly used for co-composting are open composting and bin composting. In open composting, the mixed material (sludge and solid waste) is piled into long heaps called windrows and left to decompose. Windrow piles are periodically turned to provide oxygen and to ensure that all parts of the pile are exposed to the heating of the material, facilitating pathogen die-off. Bin composting, e.g. in compost boxes, made of bricks or blocks, requires a controlled supply of moisture and air. In-vessel composting is a more sophisticated method for co-composting solid waste with faecal sludge and describes a technique where the composting materials are confined within a building, container, or vessel. It allows for better control, shortens the composting process and separates the decomposition process from the immediate environment. Due to the complex infrastructure required and the higher capital and operating costs, it is not generally appropriate for decentralised facilities. Although the composting process appears to be a simple, passive technology, a well-functioning facility requires careful planning and design, as well as accurate process monitoring. Depending on the climate and available space, the facility may be roofed to

prevent excess evaporation and/or provide shelter from rain and wind. Since moisture plays an important role in the composting process, roofed facilities are especially recommended where there is heavy rainfall. The facility should be located close to the sources of organic waste and faecal sludge to minimise transport costs, but still far enough away from homes and businesses to minimise nuisances.

Appropriateness A Co-Composting facility is only appropriate if a source of well-sorted biodegradable solid waste is available. Solid waste containing plastics and garbage must first be sorted. If done carefully, Co-Composting can produce a clean, pleasant, beneficial soil conditioner.

Apart from technical considerations, composting only makes sense if there is a demand for the product for field application or as a commercially viable commodity (from paying customers). To find customers, a consistent and high-quality compost must be produced; this depends on good pre-sorting and processing of the organic waste and a well-controlled thermophilic process.

Health Aspects/Acceptance Maintaining the temperature in the pile between 55 and 65°C can reduce the pathogen load of the sludge to the point where it is safe for handling and processing. After the thermophilic phase, re-infection of the compost by mixing it with fresh compost or even using contaminated tools should be avoided. Although the finished compost can be handled safely, care should be taken when handling the sludge, regardless of the previous treatment. The regular monitoring of pathogen levels using microbial test are necessary. More stringent controls for pathogens are required when compost is bagged and intended for sale.

If the material is found to be dusty, workers should wear protective clothing and use appropriate respiratory equipment. Proper ventilation and dust control during handling are important.

Operation & Maintenance Depending on the size of the organic waste, chipping or shredding might be necessary to increase the surface area on which microorganisms can feed and produce a more homogeneous compost mixture. However, the smaller structure of the material will reduce the airflow inside the piles. For dewatered sludge, a 1:2 to 1:3 ratio of sludge to solid waste should be used. Liquid sludge should be used at a sludge to solid waste ratio of 1:5 to 1:10. The

windrow piles should be 1 to 1,5 m high and insulated with compost, sisal bags or other removable (inorganic) materials that allow air flow, but promote even distribution of heat inside the pile. To ensure aerobic conditions and that all parts are sufficiently heated, the pile should be turned periodically. The temperature of the pile should rise to about 65°C in the first week and then fall to 40°C over the next few weeks.

Bin Co-Composting facilities are aerated through holes in the walls and/or perforated pipes and the decomposing material generally does not need to be turned. The bins or boxes need to be covered and operate in a batch process. The decomposition process is slower but can be accelerated by forced aeration.

Maintenance staff must carefully monitor the quality of the input material and keep track of the inflows, outflows, turning schedules and maturing times to ensure a high-quality product. Forced aeration systems must be carefully controlled and monitored.

Turning must be periodically done with either a front-end loader or by hand. Robust grinders for shredding large pieces of solid waste (i.e. small branches and coconut shells) and pile turners help to optimise the process, reduce manual labour and ensure a more homogenous end product.

Pros & Cons

- + Closes food production cycles
- + Produces a commercially viable product for use as soil conditioner in food production
- + Relatively straightforward to set up and maintain with appropriate training
- + A high removal of helminth eggs is possible (< 1 viable egg/g TS)
- + Can be built and repaired with locally available materials
- + Depending on the chosen technique, can have low capital and operating costs
- + For most techniques, no electrical energy required
- Most techniques require a large land area (that is well located)
- Requires expert design and operation by skilled personnel
- Labour intensive
- Compost is too bulky to be economically transported over long distances

References & Further Reading

can be found on page 249

Application Level:

- Household
- Neighbourhood
- City

Management Level:

- Household
- Shared
- Public

Inputs: Sludge Blackwater
 Brownwater Organics

Outputs: Sludge Biogas

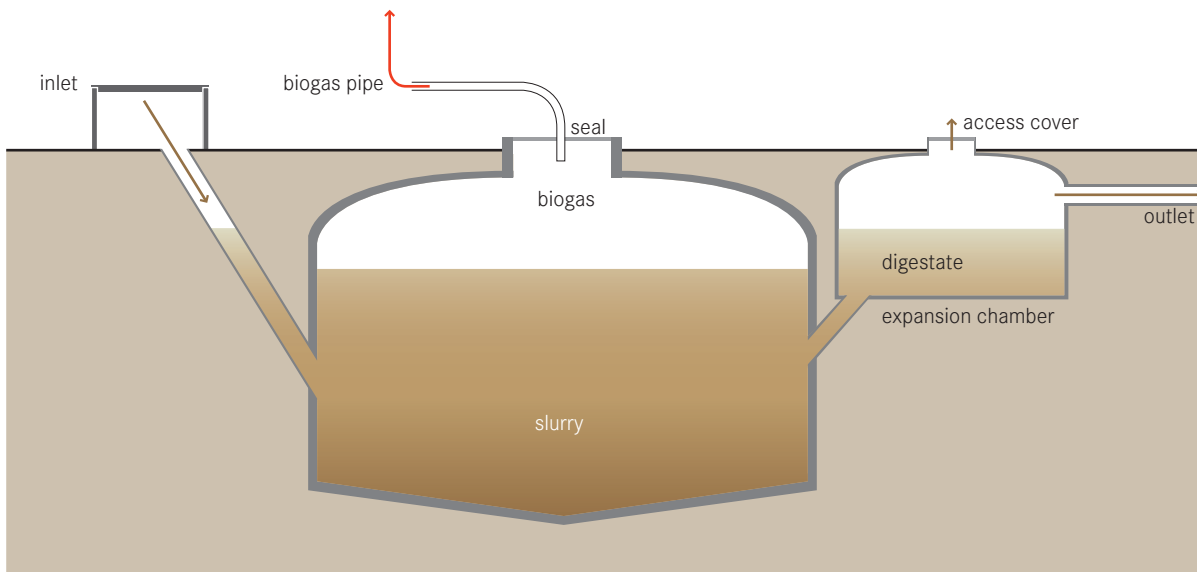

A **Biogas Reactor** or **anaerobic digester** is an **anaerobic treatment technology that produces (a) a digested slurry (digestate) that can be used as a fertiliser and (b) biogas that can be used for energy. Biogas is a mix of methane, carbon dioxide and other trace gases which can be converted to heat, electricity or light.**

A Biogas Reactor is an airtight chamber that facilitates the anaerobic degradation of blackwater, sludge and/or biodegradable waste. It also facilitates the collection of the biogas produced in the fermentation processes in the reactor. The gas forms in the slurry and collects at the top of the chamber, mixing the slurry as it rises. The digestate is rich in organics and nutrients, almost odourless and pathogens are partly inactivated.

Design Considerations Biogas Reactors can be brick-constructed domes or prefabricated tanks, installed above or below ground, depending on space, soil characteristics, available resources and the volume of waste generated. They can be built as fixed dome or floating dome digesters. In the fixed dome, the volume of the reactor is constant. As gas is generated,

it exerts a pressure and displaces the slurry upward into an expansion chamber. When the gas is removed, the slurry flows back into the reactor. The gas pressure always fluctuates depending on the difference between the liquid levels in the reactor and the expansion chamber. The pressure can be used to transport the biogas through pipes. In a floating dome reactor, the dome rises and falls with the production and withdrawal of gas, resulting in a constant gas pressure (depending on the weight of the floating dome, often a steel drum). Alternatively, the reactor can be covered with a single or a double membrane structure to store the gas. To minimise distribution losses, the reactors should be installed close to where the gas can be used. The hydraulic retention time (HRT) in the reactor should be at least 15 days in hot climates and 25 days in temperate climates. For highly pathogenic inputs, an HRT of 60 days should be considered. Normally, Biogas Reactors are operated in the mesophilic temperature range of 30 to 38°C. A thermophilic temperature of 50 to 57°C would ensure the destruction of the pathogens, but can only be achieved by heating the reactor (although in practice, this is only found in industrialised countries). Often, Biogas Reactors are

directly connected to private or public toilets with an additional access point for organic materials. At the household level, reactors can be made out of plastic containers or bricks. Sizes can vary from 1 000 L for a single family up to 100 000 L for institutional or public toilet applications. Because the digestate production is continuous, provisions must be made for its storage, use and/or transport away from the site.

Appropriateness This technology can be applied to the sedimentation and stabilisation of sludge at (Semi-) Centralised Treatment Plants. It is best used where regular feeding is possible. The highest levels of biogas production are obtained with concentrated substrates, while biogas production from wastewater/Effluent with low dry matter content is poor. Biogas Reactors are less appropriate for colder climates as the rate of organic matter conversion into biogas is very low below 15°C. Consequently, the HRT needs to be longer and the design volume substantially increased.

Health Aspects/Acceptance The digestate is partially sanitised, but still carries a risk of infection. Depending on its end-use, further treatment might be required. There are also dangers associated with the flammable gases that, if mismanaged, could be harmful to human health.

Operation & Maintenance If the reactor is properly designed and built, repairs should be minimal. To start the reactor, it should be inoculated with anaerobic bacteria, e.g. by adding cow dung or Septic Tank sludge. Organic waste used as substrate should be shredded and mixed with water or digestate prior to feeding.

Gas equipment should be carefully and regularly cleaned so that corrosion and leaks are prevented. Grit and sand that have settled to the bottom should be removed. Depending on the design and the inputs, the reactor should be emptied once every 5 to 10 years.

Pros & Cons

- + Generation of renewable energy
- + Small land area required
(most of the structure can be built underground)
- + No electrical energy required
- + Conservation of nutrients
- + Long service life
- + Low operating costs
- Requires expert design and skilled construction
- Incomplete pathogen removal, the digestate might require further treatment
- Limited gas production below 15°C

References & Further Reading

can be found on page 250

Application Level:

- * Household
 * Neighbourhood
 ** City

Management Level:

- * Household
 * Shared
 ** Public

Inputs: Excreta Faeces Sludge
 Organics Dry Cleansing Materials

Outputs: Biochar
 Bio-Oil, Syngas, Heat, (Hydrochar)

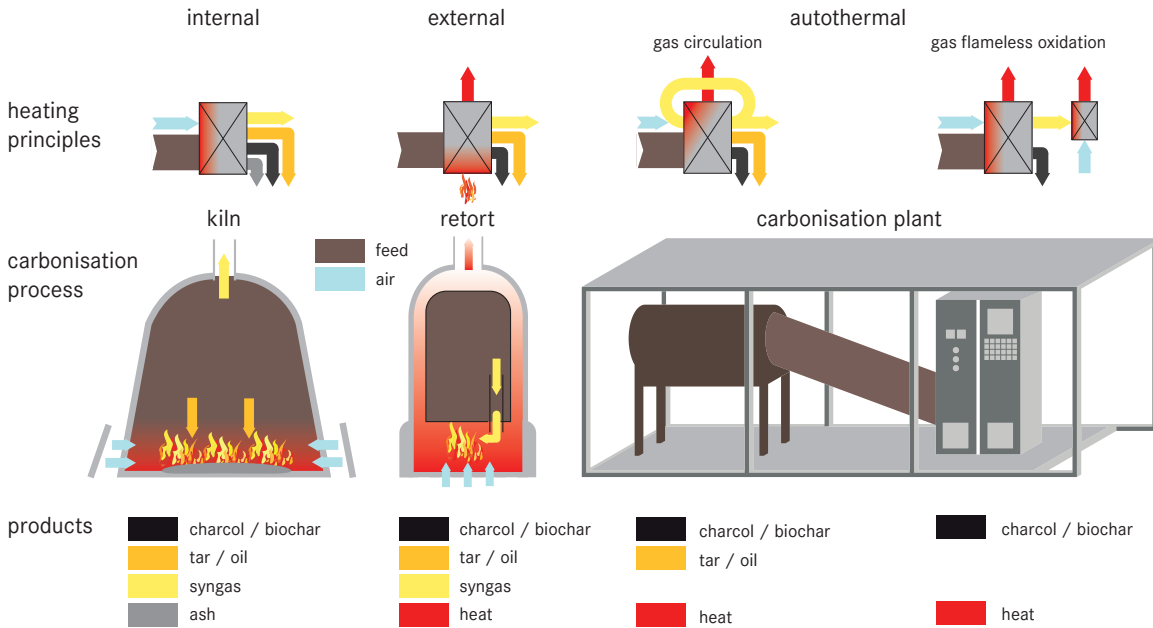

Carbonisation is the thermochemical conversion of biomass and other materials with carbon components at high temperatures in a limited oxygen environment. Carbonisation is often used as a synonym for pyrolysis, but pyrolysis is defined as a process in absence of oxygen. During Carbonisation, a limited controlled airflow is necessary for the process. Therefore, all thermochemical conversion processes described here refer to carbonisation.

The organic feedstocks are converted into a solid carbon material resembling charcoal, commonly referred to as biochar and other products, such as (bio-) oil/tar and syngas. There are several types of carbonisation processes that differ in reaction time, from slow to fast to ultra-fast carbonisation. Each process uses different temperatures, heating durations and/or reactor pressures to produce different quantities and qualities of the end products. However, the type of feedstock is also a deciding factor. Several advanced carbonisation processes allow for the reintroduction of syngas as an energy source to heat the process. Other processes with external process cycles for syngas using flameless oxidation can completely avoid the formation of oils/tars.

Design Considerations Feedstocks for carbonisation include organic materials, such as municipal solid waste, sewage sludge, wood and crop residues from agricultural land. Depending on the carbonisation process, the biomass must have a certain dry matter content to enable an efficient conversion process. An efficient carbonisation process also requires precise control of temperature, time and available oxygen.

There is a wet thermal carbonisation process known as HTC (Hydro Thermal Carbonisation) using pressure and temperatures lower than 300°C. The outcome of this process is called hydrochar and has different properties compared to biochar, in particular the persistence in soil organic environments is far lower than biochar.

Depending on the heating principle, a distinction can be made between different carbonisation processes. Kilns use internal heating energy to start the process and keep it going, while in retorts the required heat energy is supplied from outside the process reactor. The development of carbonisation plants with syngas circulation or external process cycles for syngas enables autothermal carbonisation processes where external energy is only required for process start-up.

Carbonisation can be performed using batch or continuous feed processes. While kilns (more suitable for household scale) and retorts (household and shared scale) operate mostly on the batch principle even with dual or multiple processing chambers, carbonisation plants allow a continuous operation (community and public scale). Even though the development of improved kilns, such as the Kontiki Kiln, allows for a reduction of harmful emissions during the carbonisation process, a significant environmental impact is still expected. The same applies to retorts, where better use of the released heat is possible and filters can be used to reduce harmful gas emissions. Modern carbonisation plants allow for virtually emission-free operation with various options for recovering the released heat energy.

Appropriateness Carbonisation of sludge can be usually done at a centralised level, where sludge can be dried prior to the thermal conversion treatment. Coprocessing of sludge with other biomass, such as wood, sawdust or coffee husks, can increase the biochar output and can help to reduce moisture content in the feedstock.

Health Aspects/Acceptance Depending on the carbonisation technique, the operator of the equipment may be exposed to harmful emissions. The use of filters is recommended and the use of personal protective equipment is required as well to protect against other possible accidents in carbonisation plants. The carbonisation products syngas and oils/tars pose potential health hazards. However, in the case of biochar, the contents of organic chemicals or pathogens are significantly reduced or completely eliminated during carbonisation due to the high-temperature conversion process. When biochar is used as soil conditioner, the remaining heavy metals in the resulting biochar are generally not available for uptake in growing plants. Biochar applied to the soil can work as a carbon sink due to its very slow decomposition. Simple carbonisation techniques are well known worldwide and mostly used to produce charcoal as an energy source. The development of carbonisation technologies advanced significantly in the last years in industrialised countries, but sophisticated emission free carbonisation plants are still little known in low- and middle-income countries, partially due to their considerably higher investment costs.



Operation & Maintenance Feedstock is loaded manually for batch processes, whereas in continuous feed plants, it is done mechanically using conveyor belts. Simple carbonisation facilities for household or shared use do not require highly skilled labour, while advanced carbonisation systems require well-trained operators. During operation, a controlled low oxygen environment must be ensured in the reactor. Accidental uncontrolled air supply to the carbonisation reactor, for example, through leaks, may create unstable combustion and result in explosion or fire hazards. The safe operation of a carbonisation facility requires, among other things, safety devices, such as pressure relief doors, automatic temperature shutdown and power failure devices. Kilns and retorts in batch process have relatively low investment costs. However, operating costs can be high due to the manual labour cost of charging the batch reactor(s) and the energy cost for heating to the required reaction temperature, using an external fuel source. Continuous reactors, especially zero-emission carbonisation plants, typically have high capital costs. Operating costs include electricity costs for process control and monitoring equipment and the labour cost for highly skilled personnel. The use of the released heat can reduce the operation costs.

Pros & Cons

- + Fast treatment time - generally only minutes to hours
- + Carbonisation allows for significant energy recovery
- + High temperatures of the carbonisation process destroy pathogens and organic contaminants
- + Significant volume reduction of solid residues
- + A source of revenue when biochar or other products such as energy and oils are sold
- + Biochar use as soil amendment allows for carbon sequestration
- Simpler carbonisation processes can release harmful emissions into the air and control, recovery and management of noxious process gases are expensive
- Carbonisation plants require high investment costs and well-trained operators
- Dry carbonisation processes require drying of biomass before it can be used as feedstock
- Self-ignition hazard of biochar due to oxygen chemisorption during storage or transportation

References & Further Reading

can be found on page 250

Application Level: <input type="checkbox"/> Household <input checked="" type="checkbox"/> Neighbourhood <input checked="" type="checkbox"/> City	Management Level: <input type="checkbox"/> Household <input checked="" type="checkbox"/> Shared <input checked="" type="checkbox"/> Public	Inputs:  Effluent
		Outputs:  Effluent

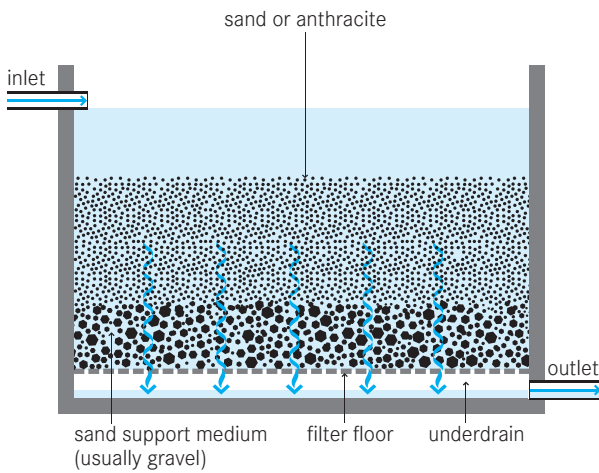

tertiary filtration (e.g., depth filtration)

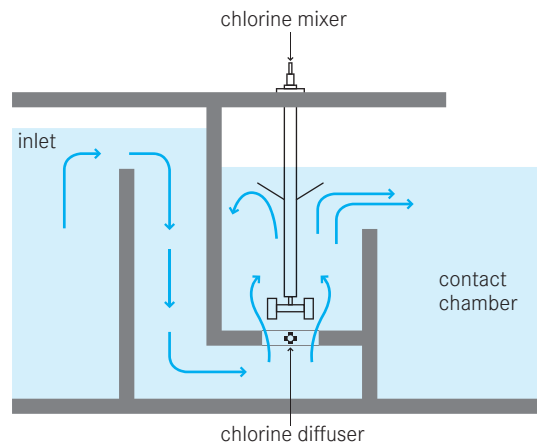

disinfection (e.g., chlorination)

Depending on the end-use of the effluent or national standards for discharge in water bodies, a post-treatment step may be required to remove pathogens, residual suspended solids and/or dissolved constituents. Tertiary Filtration and Disinfection processes are most commonly used to achieve this.

Post-treatment is not always necessary and a pragmatic approach is recommended. The effluent quality should match the intended end-use practice or the quality of the receiving water body. The WHO Guidelines for the Safe Use of Wastewater, Excreta and Greywater provide useful information on the assessment and management of the risks associated with microbial hazards and toxic chemicals.

Among a wide range of tertiary and advanced treatment technologies for effluent, the most widespread include Tertiary Filtration and Disinfection processes.

Tertiary Filtration Tertiary filtration processes can be classified as either depth (or packed-bed) filtration or surface filtration processes. Depth filtration involves the removal of residual suspended solids by passing

the liquid through a filter bed comprised of a granular filter medium (e.g. sand). If activated carbon is used as a filter medium, the dominating process is adsorption. Activated carbon adsorbers not only remove a variety of organic and inorganic compounds, they also eliminate taste and odour. Surface filtration involves the removal of particulate material by mechanical sieving as the liquid passes through a thin septum (i.e. filter layer). Membranes are also surface filters. Low pressure membrane filtration processes (including gravity-driven membrane filters) are being developed. Depth filtration is successfully used to remove protozoan cysts and oocysts, while ultrafiltration membranes can also reliably eliminate bacteria and viruses.

Disinfection The disinfection, destruction, inactivation, or removal of pathogenic microorganisms can be achieved by chemical, physical, or biological means. Due to its low cost, high availability and easy operation, chlorine has historically been the disinfectant of choice for treating wastewater. Chlorine oxidises organic matter, including microorganisms and pathogens. Concerns about harmful disinfection by-products and chemical safety, however, have increasingly led to

chlorination being replaced by alternative disinfection systems, such as ultraviolet (UV) radiation and ozonation (O₃). UV radiation is found in sunlight and kills viruses and bacteria. Thus, disinfection naturally takes place in shallow ponds (T.5). UV radiation can also be generated through special lamps, which can be installed in a channel or pipe. Ozone is a powerful oxidant and is generated from oxygen in an energy-intensive process. It degrades both organic and inorganic pollutants, including odour-producing agents. Similar to chlorine, the formation of unwanted by-products is one of the problems associated with the use of ozone as a disinfectant.

Appropriateness The decision to install a post-treatment technology depends mainly on the quality requirement for the desired end-use of the effluent and/or national standards. Other factors are the effluent characteristics, budget, availability of materials and O&M capacity.

Pathogens tend to be masked by suspended solids in unfiltered secondary effluent. Therefore, a filtration step prior to disinfection brings about much better results with fewer chemicals.

Membrane filters are costly and require expert know-how for O&M, especially, to avoid damaging the membrane. In activated carbon adsorption, the filter material is contaminated after usage and needs proper treatment/disposal. Chlorine should not be used if the water contains significant amounts of organic matter, as disinfection by-products can form. Ozonation costs are generally higher compared to other disinfection methods.

Health Aspects/Acceptance With both chlorine and ozone disinfection, by-products may form and threaten environmental and human health. There are also safety concerns related to the handling and storage

of liquid chlorine. Activated carbon adsorption and ozonation can remove unpleasant colours and odours, increasing the acceptance of reusing reclaimed water.

Operation & Maintenance All post-treatment methods require continuous monitoring (influent and effluent quality, head loss of filters, dosage of disinfectants, etc.) to ensure a high performance.

Due to the accumulation of solids and microbial growth, the effectiveness of sand, membrane and activated carbon filters decreases over time. Frequent cleaning (backwashing) or replacement of the filter material is, therefore, required. For chlorination, trained personnel are required to determine the right dosage of chlorine and ensure proper mixing. Ozone must be generated onsite because it is chemically unstable and rapidly decomposes to oxygen. In UV disinfection, the UV lamp needs regular cleaning and annual replacement.

Pros & Cons

- + Additional removal of pathogens and/or chemical contaminants
- + Allows for direct reuse of the treated wastewater
- Skills, technology, spare parts and materials may not be locally available
- Capital and operating costs can be very high
- Some technologies require a constant source of electricity and/or chemicals
- Requires continuous monitoring of influent and effluent
- Filter materials need regular backwashing or replacement
- Chlorination and ozonation can form toxic disinfection by-products

References & Further Reading

can be found on page 251

In contrast to the 2nd Edition of the Eawag Compendium, which refers to the end of the service chain as functional group D *Use and/or Disposal*, we refer to this step as R *Reuse and/or Disposal*. This is to emphasise the importance of reuse. This form of designation has already been used by the “Guide to Sanitation Resource Recovery Products & Technologies, 1st Edition (2020, SLU)” and is adopted here. This particular compendium covers numerous aspects and technologies related to reuse in detail and is highly recommended as a further resource on this subject area.









This section presents the different technologies and methods with which products are ultimately returned to the environment, either as useful resources or reduced-risk materials. If there is an end-use for the output products, they can be applied or used. Otherwise, they should be disposed of in ways that are least harmful to the public and the environment. Where relevant, the WHO Guidelines for the Safe Use of Wastewater, Excreta and Greywater are referenced in the technology information sheets.

- R.1 Application of Urine
- R.2 Application of Compost
- R.3 Application of Sludge
- R.4 Application of Effluent/ Irrigation
- R.5 Soak Pit
- R.6 Leach Field
- R.7 Fish Pond
- R.8 Floating Plant Pond
- R.9 Water Disposal/Groundwater Recharge
- R.10 Surface Disposal and Storage
- R.11 Biogas Combustion
- R.12 Application of Biochar

In any given context, the technology choice generally depends on the following factors:

- Type and quality of products
- Socio-cultural acceptance
- Local demands
- Legal aspects
- Availability of materials and equipment
- Availability of space
- Soil and groundwater characteristics



Application Level:	Management Level:	Inputs:  Stored urine
 Household	 Household	Outputs:  Biomass
 Neighbourhood	 Shared	
 City	 Public	

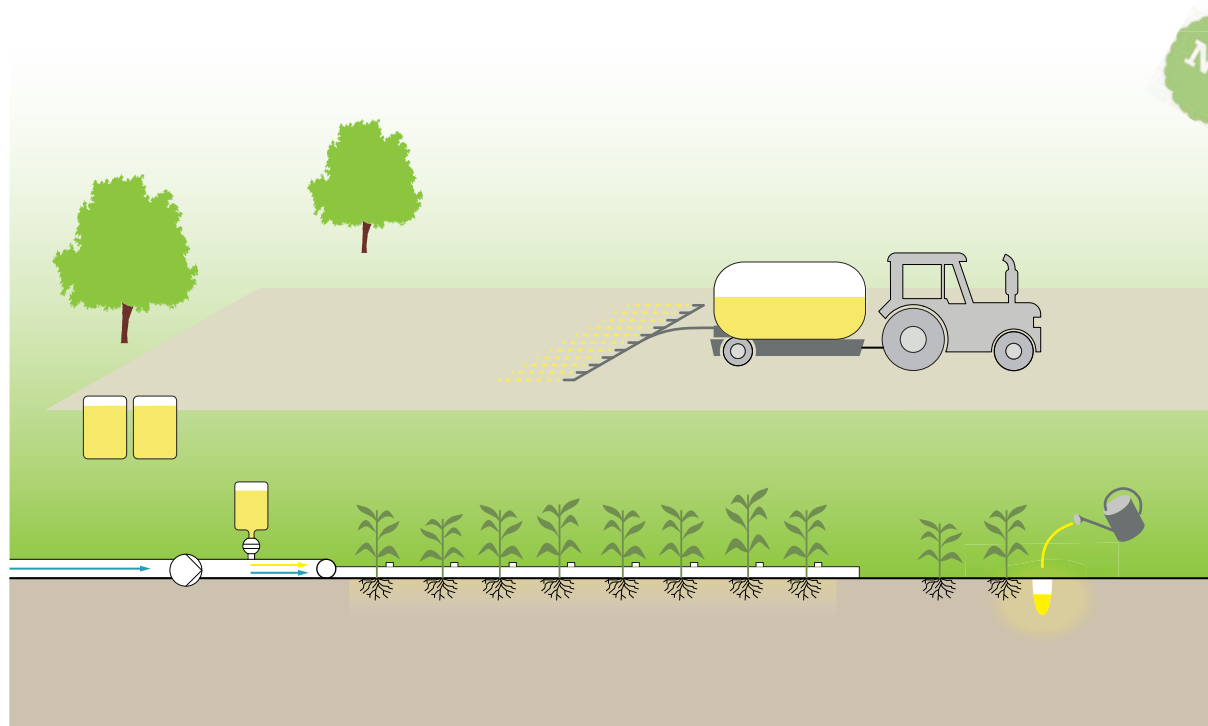

Stored urine is a concentrated source of nutrients that can be applied as a liquid fertiliser in agriculture. Urine can be as effective as commercially-available synthetic fertiliser. Proper storage and application methods should minimise nitrogen (N) losses through ammonia volatilisation. Other methods of processing and use of urine in agriculture are described in detail in the “Guide to Sanitation Resource Recovery”, p. 76ff: Nitrification and Distillation, Struvite Precipitation and Alkaline Dehydration.

Urine contains most of the nutrients excreted by the body. Its composition varies depending on diet, gender, climate, water intake, etc., but about 80-85% of the nitrogen, up to 66% of the phosphorus and 74% of the potassium excreted by the body are in the urine (Rich Earth Institute). Urine also contains a wide range of micronutrients important for plant growth that are not present in most commercially available fertilisers.

Urine should be stored before reuse in containers that are sealed to avoid nitrogen losses (S.1 Storage Tank/ Container). Storage guidelines for urine depend on the storage temperature and the intended crop for which it

is to be used as fertiliser, but all urine should be stored for at least one month (for application to some crops six month) before use (WHO, 2006, specific guidelines for storage and use of urine).

Design Considerations Application method and environmental conditions during application are important factors to consider to avoid or reduce nutrient losses, especially nitrogen losses. The Rich Earth Institute recommends applying urine to moist soil and under high humidity conditions. To minimise ammonia losses during application, spraying should be avoided. Instead, urine should be applied near the ground or better in the soil. Urine can be applied by hand and poured into furrows which should be covered immediately. When using not stored urine, it should be diluted up to 1:10 with water. During the rainy season, urine can also be applied directly into small holes near plants; then, it will be diluted naturally. Simple, tractor-driven application equipment with a tank and drag hoses can be used to apply urine to grassland and hayfields. More complex liquid fertiliser applicators, which open the soil surface with discs, can be used for urine application before planting or better

for side fertilisation of plant rows in the first stages of growth. This allows for more effective application to the fields as nitrogen losses are minimised. Fertiliser injectors are used to “inject” a predetermined amount of liquid fertiliser from a holding tank into the irrigation system. This technique is also known as fertigation (R.4) and is a good way to provide a constant and uniform flow of nutrients to plants.

Appropriateness Urine application is especially suitable for rural and periurban areas where agricultural lands are close to the point of urine collection. Crops with high nitrogen demand grow well with urine fertilising, e.g. maize, rice, millet, sorghum, wheat, carrots, cabbage, bananas, papaya and oranges.

Households can use their own urine on their own plot of land. Alternatively, if facilities and infrastructure exist, urine can be collected at a Semi-Centralised location for distribution and transport to agricultural land. Regardless, the most important aspect is that there is a demand for nutrients from fertiliser for agriculture which can be supplied by the stored urine. When there is no such need, the urine can become a source of pollution and a nuisance. Another beneficial use of urine is as an additive to enrich compost. Urine added to carbon-rich materials, such as straw, dead leaves and plant stems or paper, can balance the C:N ratio and enhance the composting process.

Health Aspects/Acceptance From healthy people, urine is virtually free of pathogens. Therefore, urine poses a minimal risk of infection, especially when it has been stored for an extended period of time. Yet, urine should be carefully handled and personal protective equipment (gloves) and handwashing are recommended when applying urine. It should not be applied to crops less than one month before they are harvested. This waiting period is especially important for crops that are consumed raw (refer to WHO guidelines for specific guidance).

Due to a lack of social acceptance, people may find it difficult to handle urine or consume products fertilised with it. Stored urine has a strong odour and handling it may be perceived as unpleasant or offensive. When urine is diluted and/or immediately tilled into the soil, the odour nuisance is reduced. The use of urine may be less acceptable in urban areas, even if there are gardens near the houses where urine can be directly applied. There may be a greater acceptance in rural areas where there is a greater distance between houses and cropland.

Operation & Maintenance When applying stored urine, its high pH must be considered. Since urine contains more nitrogen than any other nutrient, the application rate should be calculated based on the nitrogen recommendations for each crop. If this amount of urine does not provide enough potassium or phosphorus, it is advisable to add compost, mineral or other fertilisers. In addition to the nitrogen demand, the optimum application rate depends on the nitrogen concentration of the liquid, the soil conditions, as well as the efficiency of the application method, considering the rate of ammonia loss during application. Under particular soil and climatic conditions, high urine application can contribute to soil salinisation. As a rule of thumb, it can be assumed that 1 m² of arable land can receive 1.5L of urine per growing season (this amount corresponds to the average daily urine production of one person and is equivalent to an application rate of 40-110 kg N/ha). The urine of one person during one year is, therefore, sufficient to fertilise 300 to 40 m² of cropland. Since the nutrients contained in urine are readily available to plants, it is recommended to apply urine in more than one application during the growing season, e.g. after germination and before seed or fruit development. This also reduces the risk of nitrogen leaching into the subsoil and groundwater. Equipment used to apply urine must be cleaned after use to avoid malfunction or clogging due to precipitation of minerals (especially calcium and magnesium phosphates).

Pros & Cons

- + Replaces costly chemical fertilisers
- + Low risk of pathogen transmission
- + Low costs for home garden application
- + Closing to a wide extent the food nutrient loop
- Urine is heavy and difficult to transport
- Smell may be offensive
- Special equipment required for larger scale field applications
- Labour intensive
- Risk of soil salinisation if the soil is prone to the accumulation of salts
- Social acceptance may be low in some areas
- Possible loss of ammonia to air and associated environmental risks
- Risk of clogging of piping and equipment
- Social acceptance may be low

References & Further Reading

can be found on page 251

Application Level:	Management Level:	Inputs: <input checked="" type="checkbox"/> Compost
<input checked="" type="checkbox"/> Household	<input checked="" type="checkbox"/> Household	Outputs: <input checked="" type="checkbox"/> Biomass
<input checked="" type="checkbox"/> Neighbourhood	<input checked="" type="checkbox"/> Shared	
<input checked="" type="checkbox"/> City	<input checked="" type="checkbox"/> Public	

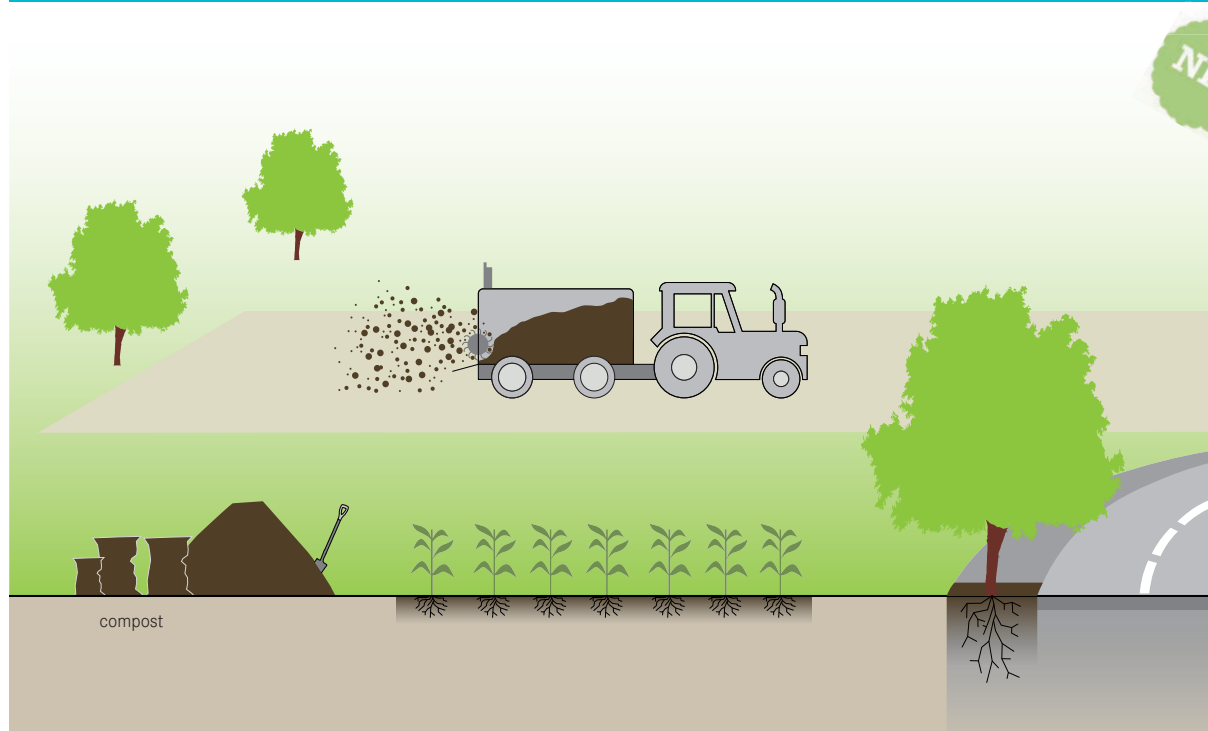

Compost is a humus-rich material produced by the controlled aerobic decomposition of organics as described in T.17 Co-Composting. During this decomposition process, the organic materials heat up to 65°C, which kills most pathogens and the compost produced can be used in agriculture.

Compost is an effective soil conditioner that increases the humus content of the soil. This improves:

- the soil structure and, thus, aeration and living conditions of soil bacteria,
- the nutrient and water-holding capacity,
- tends to form stable organic-mineral complexes (depending on soil structure and properties).

Even though the content of macronutrients (N, P, K) is relatively low, the application of compost to the soil can sustainably improve the nutrient supply of plants by binding nutrients in plant-available form.

Design Considerations Compost is a product of Co-Composting of processed primary or secondary sludge and organic material. Therefore, it must be ensured that it does not contain pathogens that could pose a hazard during handling. A sufficiently matured

compost (T.17) is black or dark brown in colour, has ambient temperature and a pleasant smell similar to humus (smell of forest soil). If the compost is produced near the places of use or fields, it can be transported in bulk. As a commercially usable product, it must be packed in bags.

Appropriateness As soil conditioner, compost has a wide range of possible applications in home gardening, horticultural production, agriculture and urban greening. Especially in soils with low organic matter content, the application of compost can significantly increase productivity.

Health Aspects/Acceptance If it has a black colour and a pleasant smell, it is easily accepted. However, the fact that it is produced from processed human excreta could cause resistance to its use. Therefore, appropriate labelling and information, e.g. on the bags, should inform the user about its processing and explain its proper use.

If the compost is free from harmful pathogens, no special care is necessary for its use and application. The main health hazard comes from pathogens that remain after

an incomplete or improperly performed composting process (e.g. too low temperatures). Therefore, only quality-controlled compost should be used. Some countries have norms and standards classifying bagged compost into categories with more or less restrictions on handling and use. The quality of the compost also depends strongly on the original organic components added to the composting pile or bin. Inorganic or organic contaminants, e.g. pesticides, that do not decompose completely or at all can contaminate the compost and, thus, the soil. Personal protective equipment, such as gloves and face masks should be worn when handling compost, especially if the quality of the compost is not fully controlled. This, along with proper ventilation, is even more necessary, when working inside, e.g. when bagging the compost. As with other wastewater treatment products, the guidelines for safe use should be consulted and followed (WHO, 2006).

Operation & Maintenance Compost can be applied by hand in small quantities in home gardens, in larger quantities on horticulture crops or in planting holes when planting trees (e.g. urban greening). Field application should be done mechanically with a manure spreader. The correct dosage depends on a variety of factors, such as the type of soil, the crop chosen, the stage of development of the plants and most importantly, the availability of compost and the costs. When applied in home gardens, a good rule of thumb is to cover the soil with 2-5 cm of compost and work it in superficially. In horticulture, the use of compost ranges from application as soil conditioner to use purely as planting substrate. Recommendations for field application rates of compost vary widely, but 9-20 t/ha per year is a margin suitable for a wide range



of soil conditions and crops (US Compost Council and Roman, P. et al., 2001). Compost intended for sale is bagged and labelled as compost or organic soil conditioner. To obtain a high quality of commercially viable compost, the composting process must be carefully monitored and controlled, with the specific aim of reducing pathogens. The finished compost must be screened and stored under suitable conditions to prevent reinfection with pathogens or fungi.

Pros & Cons

- + Improves soil fertility for a sustainable agricultural or horticultural production
- + Closes the food cycle (from farm to fork - and back to farm)
- + Improves the soil structure and, thus, the circulation of air
- + Improves water-holding capacity of the soil
- + Improves the capacity of the soil to hold plant available nutrients and, therefore, fertiliser efficiency
- + Low risk of pathogen transmission when properly controlled
- + Relative low costs
- Needs a control of pathogens through treatment monitoring
- Needs protection measures (e.g. personal protective equipment) for handling
- Social acceptance of compost from human waste may be limited
- Compost is bulky and the volume makes the transport over large distances difficult and expensive

References & Further Reading

can be found on page 251

Application Level:	Management Level:	Inputs:  Sludge
<input type="checkbox"/> Household	<input checked="" type="checkbox"/> Household	Outputs:  Biomass
<input checked="" type="checkbox"/> Neighbourhood	<input checked="" type="checkbox"/> Shared	
<input checked="" type="checkbox"/> City	<input checked="" type="checkbox"/> Public	

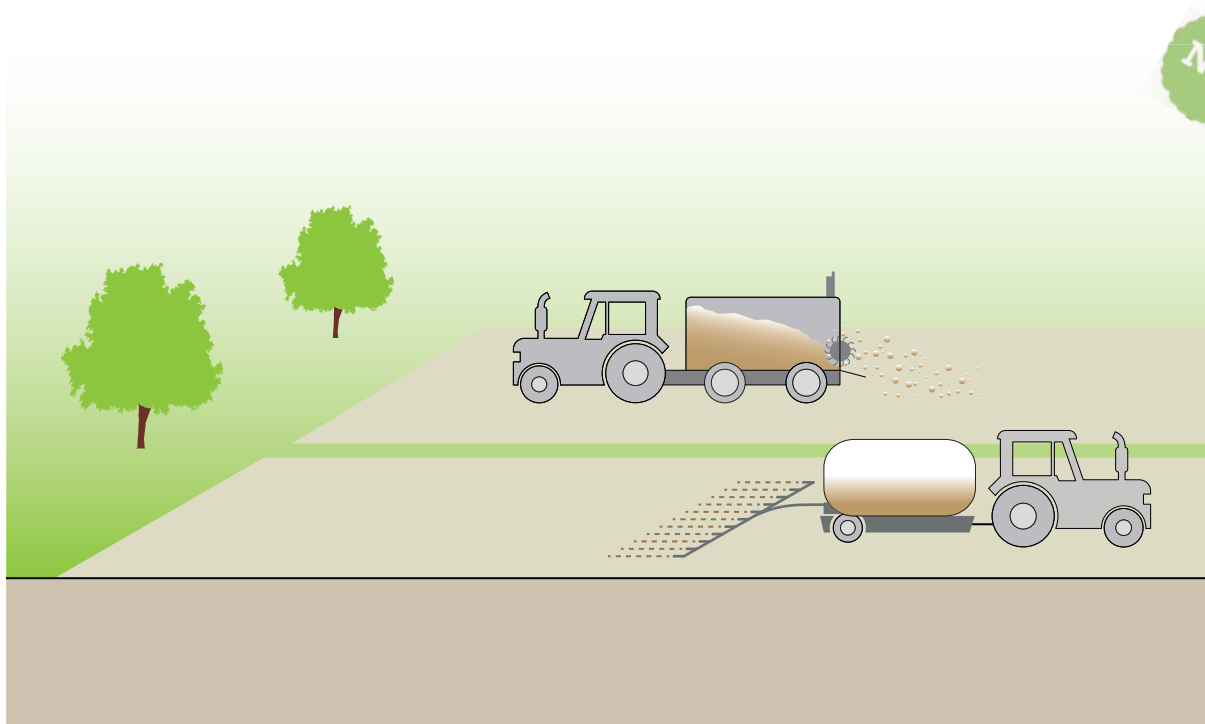

Depending on the treatment type and quality, digested or stabilised sludge can be applied to public or private lands for landscaping or use as fertiliser and soil amendment in agriculture.

Sludge that has been treated (e.g. in Planted Drying Beds) has a wide range of reuse options and can be used in agriculture, home gardening, forestry, sod and turf growing, landscaping, parks, golf courses, mine reclamation, as a dump cover, or for erosion control. Sludge can improve the soil organic matter content and serve as a fertiliser. Although the nutrient content of sludge is low compared to commercial fertilisers (especially regarding such macronutrients as nitrogen, phosphorus and potassium), it can cover a part of the nutrient demand of plants. In addition, treated (i.e. digested or stabilised) sludge applied to the soil has the ability to increase soil aeration, as well as nutrient and water holding capacity. In the soil, it slowly and steadily releases nutrients to plants.

Design Considerations Solid sludge can be applied by spreading it on the ground surface. Depending on the dry matter content, conventional

manure spreaders, tank trucks or specially designed vehicles can be used. Liquid sludge (e.g. from anaerobic reactors) can be sprayed onto or injected into the ground.

The calculation of application rates for sludge should take into account the soil type, the crop requirements, the application time and the nutrient content of sludge. Other factors that need to be considered are the potential presence of pathogens and contaminants. After sludge application at the beginning of the growing season, the soil should be tilled superficially to avoid that it is drying at the surface. This would result in nutrient losses and can limit the air and water infiltration capacity of the soil. High rates of sludge in one application can lead to over fertilisation and possible nutrient leaching into the groundwater. The rate of sludge and the application time should be carefully monitored to prevent organic pollution. Heavy rainfall, for instance, directly after sludge application without soil cover (tillage) can result in surface runoff.

Appropriateness Depending on the source, sludge can serve as a valuable soil conditioner and as a source of nutrients. Sludge from domestic wastewater

treatment pose low risks as a source of contamination of heavy metals. Sludge that originates from large-scale wastewater treatment plants is more likely to be contaminated since it can receive industrial and domestic chemicals, as well as surface water run-off, which may contain hydrocarbons and heavy metals. If the quality of the sludge makes reuse possible, the application of sludge on land is usually a more cost-effective and sustainable option than surface disposal.

Health Aspects/Acceptance Acceptance of the use of sludge can be low and a major barrier to its use. However, even if its use in agriculture is not accepted, the wide range of other usage options offers alternatives at the local level and in the surrounding area (e.g. in landscaping) or in local industry (e.g. as an energy source). Depending on the source of the sludge and the treatment technology, sludge should be treated to a level where low pathogen content allows for safe handling and it does not generate odour nuisance. Following guidelines for safe handling and application is required, including safety measures for harvesting and the safe consumption of the agriculture products. WHO guidelines on excreta use in agriculture should be consulted for detailed information (WHO, 2006).

Operation & Maintenance The cleaning of the spreader and other equipment after each use is an important operation task. Motorised equipment

must be properly maintained to ensure serviceability. The amount and rate of sludge application should be carefully monitored to prevent organic pollution. Workers should use personal protective equipment, including gloves and face masks and wear appropriate protective clothing, such as rubber boots.

Pros & Cons

- + Provides organic matter and to some extent nutrients that replace chemical fertiliser
- + Improves the aeration and water-holding capacity of soil
- + Can be used to prepare soils for reforestation
- + Can reduce soil erosion
- + Depending on the necessary transport, it can be a low cost soil conditioner
- + Has a wide range of possible reuse options
- Requires control of potential pathogens content
- Requires protection measures (e.g. personal protective equipment) for handling
- Acceptance for reuse can be low
- Risk of groundwater contamination, if applied in high dosages
- Risk of heavy metal accumulation in the soil when sludge is contaminated
- May pose public health risks in an epidemic event

References & Further Reading

can be found on page 252

Application Level:	Management Level:	Inputs:
(**) Household (**) Neighbourhood (**) City	(**) Household (**) Shared (**) Public	Effluent Stormwater (+ Stored urine)
		Outputs: Biomass

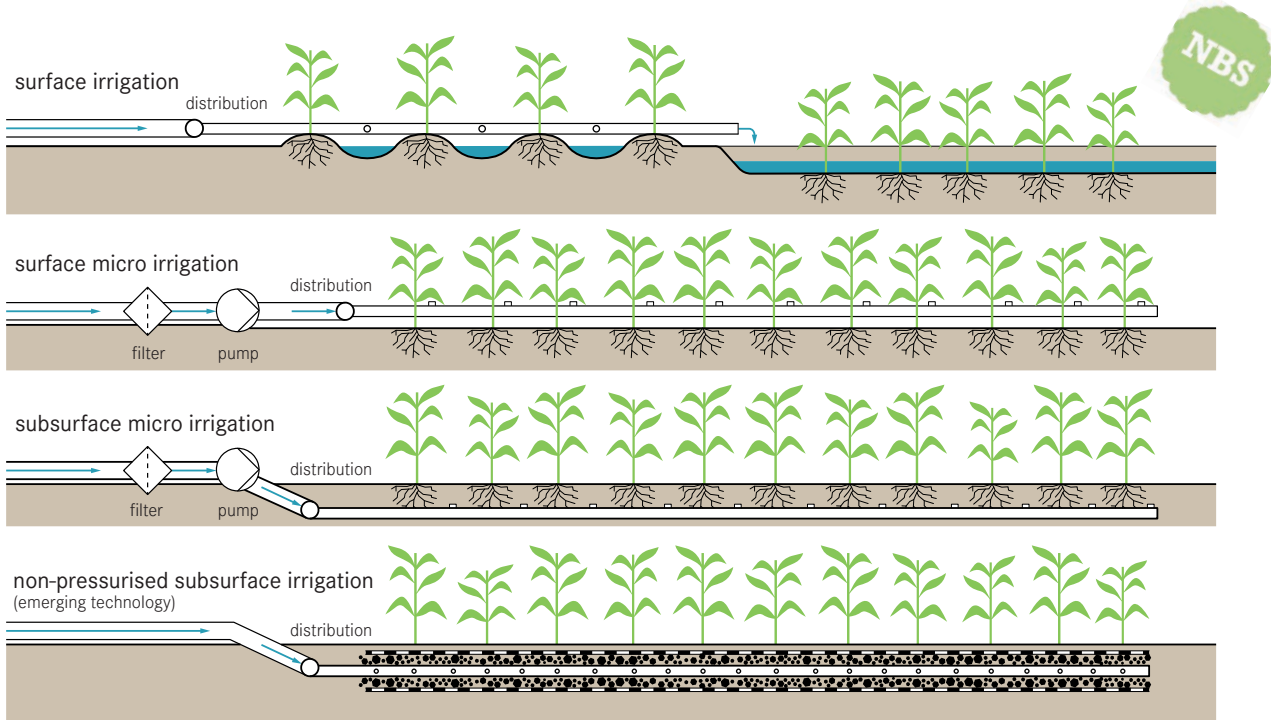

Effluent is the liquid that leaves a technology, typically after blackwater, wastewater or sludge has undergone solids separation or further treatment. Depending on the type of treatment, the effluent may comply with reuse standards or may require further treatment. For the application in agriculture, horticulture or urban greening, the effluent should have undergone secondary treatment (i.e. physical and biological treatment, see Glossary) to avoid environmental hazards, crop contamination and limit health risks to the operators. Further post-treatment can be necessary. Exceptions to the reuse of effluent from on-site treatment technologies (e.g. application of septic tank effluent in household gardens) require special safety measures (WHO, 2006).

The use of effluent for irrigation can be substitute for fresh water, allowing for crop irrigation even when other water sources are not available. Recycling of nutrients is another important reason for the application of effluent to crops. Instead of separating nutrients in (often costly) processes to comply with increasingly stringent standards for discharge into water bodies,

they can be directly used for plant growth, thus, closing nutrient cycles. Effluent from (Semi-) Centralised wastewater treatment plants can be applied to crops as the only source or as a supplement to irrigation water from other sources.

The form and technique of irrigation pose different requirements to the quality and characteristics of the treated effluent and, thus, to the treatment process and its results. Therefore, it is essential to plan the sanitation system from the end and to involve the agricultural or horticultural user of the treated effluent in the planning process from the beginning. This can include the selection of an appropriate site for the treatment plant, as shown in Case Study 6, where farmers offered a site close to their fields.

Design Considerations There are different irrigation techniques, which can be divided into surface and subsurface irrigation systems. Within these systems, a distinction can be made between techniques that distribute the water by open flow without pressure, e.g. through furrows, pipes or flooding of the fields. Other irrigation techniques, such as sprinklers or drip irrigation, require the water to be fed into pipes under

pressure using pumps or gravity pressure in order to distribute it to the fields. Similar distinction apply to subsurface irrigation systems.

Each technique involves more or less direct contact of the effluent with workers in the fields, crops and products being harvested. Therefore, each technique entails specific quality requirements in terms of pathogen removal, as well as the intensity of treatment before irrigation. In general, subsurface irrigation techniques minimise these contacts (except for root crops), but they are more complex and more difficult to manage.

Flood and furrow irrigation are simple techniques requiring a slope to distribute the water in the field. The installation is often low-cost, but maintenance and operation of these techniques are labour-intensive. They involve an intense contact between the distributed effluent and the worker, as well as the crops. Distribution is uneven and not very efficient, resulting in more water infiltrating and seeping into deeper soil layers.

Sprinkler irrigation is not recommended for the distribution of effluent to avoid high evaporation and the contamination of air and plant surfaces with pathogens that potentially remain after treatment.

Micro-irrigation techniques, such as micro-sprinklers/bubblers and drip irrigation, are very efficient for a uniform distribution and limit the contact with workers and crops, but are prone to clogging. Therefore, the effluent must be filtered before use to reduce suspended solids. Micro-irrigation requires a pressure pipe system. The installation and maintenance of the system is costly, but its operation is less labour-intensive.

Subsurface micro-irrigation techniques further reduce the contact with workers and crops, but implies higher investment costs and the maintenance is more difficult because the piping system is underground. They allow for a very efficient distribution and avoid evaporation. As with other micro-irrigation techniques, the effluent must be pre-filtered.

Non-pressurised subsurface irrigation

techniques are being developed to enable irrigation with effluent to reduce operational and maintenance requirements and to avoid surface distribution, e.g. in urban and periurban areas for urban greening. 4" pipes are placed levelled in trenches in a gravel bed rolled up by geotextiles and vented above. As an emerging technology, it is still under development and most documentation is grey literature only.

Irrigation techniques with less precise distribution and higher infiltration into the ground also partly function as groundwater recharge. This must be taken into account when designing the system (R.9).

Other application techniques

are used for the distribution of effluent (see illustration above). Tractor-driven applications use equipment with a tank and drag hoses (e.g. on grassland) or more complex liquid fertiliser applicators (e.g. for field crops). Due to the high operation cost, these techniques are only suitable if other forms of irrigation cannot be used or if the application of effluent can be combined with the application of a liquid fertiliser.

The use of tank trucks to irrigate urban green spaces is a common practice. To avoid public health hazards from pathogens, the effluent must be post-treated to meet required standards. Manual application of effluent is only an option if the treatment facility is located close to the application site, e.g. the residential garden with an on-site treatment facility. When applying effluent that may have higher concentrations of pathogens, it is necessary to select the plant species (e.g. ornamental plants) and the application time accordingly, use personal protective equipment, cover the application site with soil and follow other safety measures (WHO, 2006).

Industrial reuse of effluent includes concrete production, road construction and other water-consuming industrial processes, e.g. cooling. Again, the pathogen concentration in the effluent must be controlled and appropriate safety measures must be followed during application, e.g. when spraying effluent during road construction, workers must keep their distance from the spreader and use personal protective equipment.

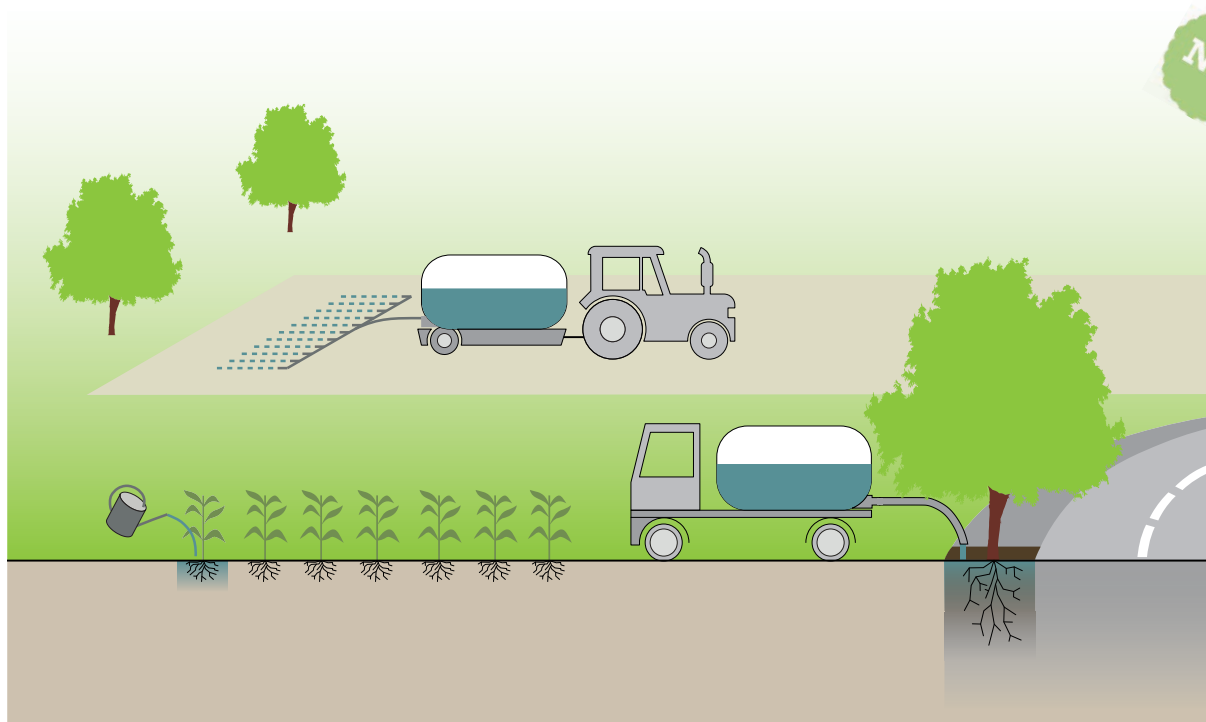

Appropriateness For the planning of an irrigation scheme for agricultural effluent reuse, various factors have to be considered:

- Crop selection/ requirements
- Climatic conditions with rainfall, temperature and sunshine duration
- Soil conditions: soil texture, infiltration rate and water holding capacity
- Topographic conditions
- Groundwater level
- Available labour and capital
- Legal requirements

The appropriate irrigation technique should be selected considering these factors, as well as the farmers' experience. Other decisive factors are the available quantity and quality of effluent.

While the seasonal water demand of the selected crops varies, according to the aforementioned factors, the daily available quantity of effluent remains relatively stable. There can be months, e.g. in the rainy season, when irrigation is not practical. Therefore, reuse for irrigation must be combined with other uses, e.g. surface water discharge or groundwater recharge.

Continuous irrigation with effluent can lead to the

accumulation of salts in the soil, especially where evaporation rates are high. The use of urine (R. 1) together with treated wastewater for irrigation (fertigation) can increase the fertilising effect, but implies an even higher risk of soil salinisation.

Health Aspects/Acceptance Where water is scarce, acceptance of the use of effluent for irrigation is often high. Appropriate secondary treatment is a prerequisite for use in crop irrigation and adequate pathogen reduction and control should precede any irrigation program to limit health risks to those who come into contact with the treated wastewater and the crop products. Every irrigation technique results in a specific way and intensity of contact with the field workers, therefore, the requirements for their protection are different. While personal protective equipment like boots and gloves and even face masks are necessary for workers who distribute effluent in flood and furrow irrigation schemes, this is only required for maintenance tasks in micro-irrigation schemes.

Plants that are not consumed directly, such as fibres (e.g. cotton) or ornamental plants, are unlikely to

pose a health risk. Forage crops, such as alfalfa, forage maize (corn) or grassland, as well as crops that undergo a fermentation process before consumption (e.g. tobacco, tea), should be subject to higher pathogen reduction requirements and restrictions than the first group, e.g. discontinuation of irrigation with effluent a certain time before harvest. Irrigation of plants for human consumption should preferably be selected where the product grows at a certain distance from the soil, as in the case of fruit trees (e.g. banana, mango, orange or papaya trees).

Specific vegetables can be irrigated with effluent, especially with micro-irrigation techniques that avoid direct contact between the effluent and the product (e.g. tomatoes, peppers and eggplants). In this case, special precautions are required, including limiting the application time, post-harvest treatment (e.g. washing) and heating (cooking) before consumption. Horticultural crops with direct contact with the soil, especially if they are eaten raw (e.g. lettuce), must not be irrigated with effluent, even if these products are washed before consumption, unless it can be ensured that the effluent is completely pathogen-free.

For safe use of the effluent in horticulture or agriculture and the safe consumption of the food products, additional protective measures are required depending on the type of crop, the form, type and time of harvest, post-harvest treatment and consumption habits. The WHO guidelines on the use of wastewater in agriculture should be consulted for detailed information and specific guidance (WHO, 2006).

Operation & Maintenance Each application/irrigation technique has its specific requirements for operation and maintenance. Furrow irrigation systems require regular cleaning of distribution channels and restoration of furrows. Micro-irrigation schemes require regular cleaning and maintenance of the filter. The system must be constantly monitored to detect water leaks in the piping system and flushed frequently with clear water to prevent biofilm growth and clogging of drippers or micro-sprinklers/bubblers. Non-pressurised subsurface irrigation schemes should have control chambers at least every 30 m so that the flow can

be monitored and the pipes be cleaned with a wire-mounted brush when necessary. Motorised application techniques require cleaning of application equipment after use and regular maintenance of the trucks. According to the technique of application, workers should wear appropriate protective clothing.

Pros & Cons

- + Closes the water and the nutrient cycle
- + Replaces the use of surface and groundwater and , thus, contributes to the reduction of the depletion of groundwater and improves the availability of drinking water
- + Reduces or stops the purchase of fertiliser and, thus, brings cost reductions and reduces CO₂ emissions
- + Potentially higher yields
- + Brings organic material into the soil
- + Potential for local job creation and income generation
- + Low capital cost for flood and furrow irrigation
- + High distribution efficiency of micro-irrigation techniques and low to moderate operation and maintenance requirements
- Low distribution efficiency and high operation and maintenance requirements for flood and furrow irrigation
- High capital costs for micro-irrigation techniques, requires expert design and installation, not all parts and materials may be locally available
- Micro-irrigation systems are very susceptible to clogging, so the water must be as free as possible from suspended solids
- Risk of transmission of pathogens in case of improper treatment and application of wastewater
- Acceptance might be low where social barriers exist against the use of treated wastewater from human excreta
- Potential salinisation of soil if soil and environmental conditions are prone to accumulation of salts and irrigation is not planned and scheduled appropriately
- Potential eutrophic pollution of surface water where treated wastewater is applied in excessive quantities

References & Further Reading

can be found on page 252

Application Level:	Management Level:	Inputs:
<input type="checkbox"/> ** Household <input type="checkbox"/> * Neighbourhood <input type="checkbox"/> City	<input type="checkbox"/> ** Household <input type="checkbox"/> ** Shared <input type="checkbox"/> Public	<input type="checkbox"/> Effluent <input type="checkbox"/> Greywater <input type="checkbox"/> Urine <input type="checkbox"/> Stored urine <input type="checkbox"/> Anal cleansing water

NBS

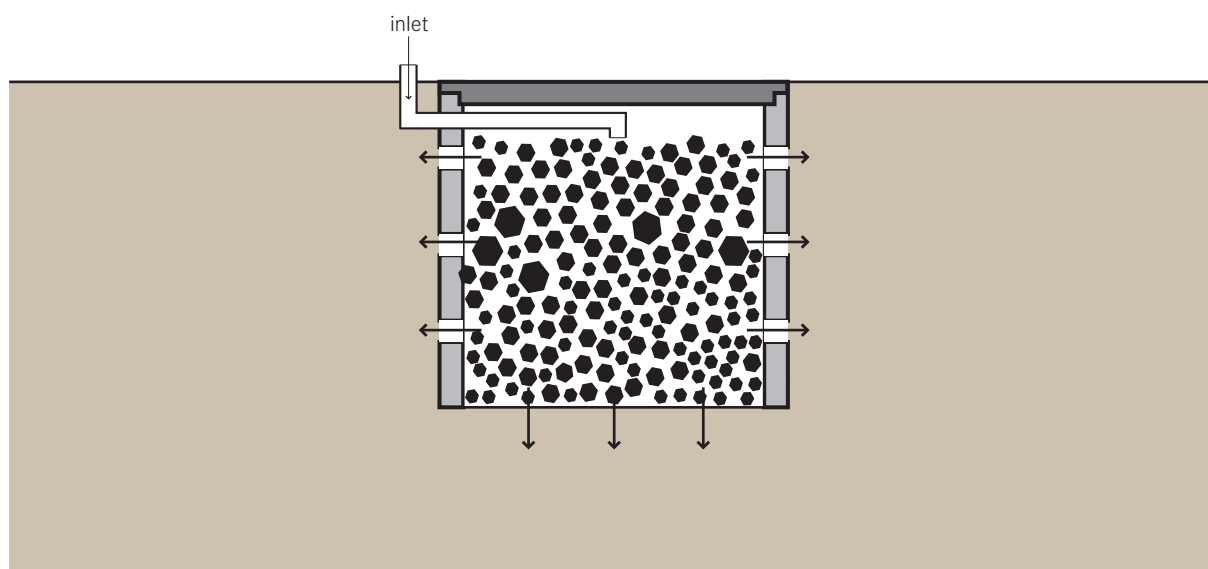

A Soak Pit, also known as a soakaway or leach pit, is a covered, porous-walled chamber that allows for water to slowly soak into the ground. Pre-settled effluent from a Collection and Storage/Treatment or (Semi-) Centralised Treatment technology is discharged to the underground chamber from which it infiltrates into the surrounding soil.

As wastewater (greywater or effluent from primary treatment of blackwater) percolates through the soil from the soak pit, small particles are filtered out by the soil matrix and organics are digested by microorganisms. Thus, Soak Pits are best suited for soil with good absorptive properties; clay, hard packed or rocky soil are not appropriate.

Design Considerations The Soak Pit should be between 1.5 and 4 m deep, but as a rule of thumb, never less than 2 m above the groundwater table. It should be located at a safe distance from a drinking water source (ideally more than 30 m). The Soak Pit should be kept away from high-traffic areas so that the soil above and around it is not compacted. It can be left empty and lined with a porous material to provide support and prevent collapse, or left unlined and filled with coarse rocks and gravel. The rocks and gravel will prevent the walls from collapsing, but will still provide adequate space for the wastewater. In both cases, a layer of sand and fine gravel should be spread across the bottom to help disperse the flow. To allow for future access, a removable (preferably concrete) lid should be used to seal the pit until it needs to be maintained.

Appropriateness A Soak Pit does not provide adequate treatment for raw wastewater and the pit will quickly clog. It should be used for discharging effluent from pre-treated blackwater or greywater. Soak Pits are appropriate for rural and periurban settlements. They depend on soil with a sufficient

absorptive capacity. They are not appropriate for areas prone to flooding or that have high groundwater tables. Moreover, if the density of Soak Pits becomes high the risk of groundwater pollution also increases.

Health Aspects/Acceptance As long as the Soak Pit is not used for raw sewage and as long as the previous Collection and Storage/Treatment technology is functioning well, health concerns are minimal. The technology is located underground and, thus, humans and animals should have no contact with the effluent. Since the soak pit is odourless and not visible, even the most sensitive communities should accept it.

Operation & Maintenance A well-sized Soak Pit should last between 3 and 5 years without maintenance. To extend the life of a Soak Pit, care should be taken to ensure that the effluent has been settled and/or filtered to prevent the excessive build-up of solids. Particles and biomass will eventually clog the pit and it will need to be cleaned or moved. When the performance of the Soak Pit deteriorates, the material inside the soak pit can be excavated, cleaned and refilled or replaced. Personal protective equipment is

required for this maintenance and the desludged solids need to be disposed of safely.

Pros & Cons

- + Can be built and repaired with locally available materials
- + Technique simple to apply for all users
- + Small land area required
- + Low capital and operating costs
- Primary treatment is required to prevent clogging
- May negatively affect soil and groundwater properties

References & Further Reading

can be found on page 252

Application Level:

- Household
 Neighbourhood
 City

Management Level:

- Household
 Shared
 Public

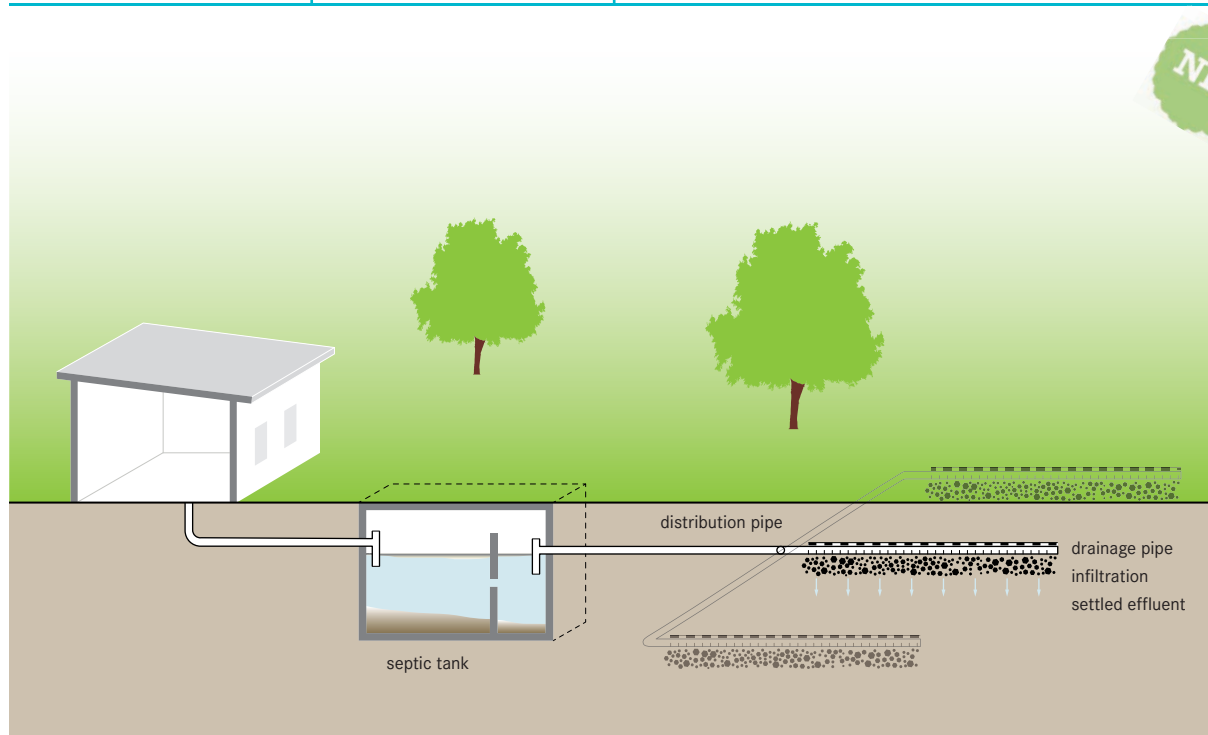
Inputs: Effluent

A Leach Field, or drainage field, is a network of perforated pipes that are laid in underground gravel-filled trenches to dissipate the effluent from a water-based Collection and Storage/Treatment or (Semi-) Centralised Treatment technology.

Pre-settled effluent is fed into a piping system (distribution box and several parallel channels) that distributes the flow into the subsurface soil for absorption and subsequent treatment. A dosing or pressurised distribution system may be installed to ensure that the whole length of the Leach Field is utilised and that aerobic conditions are allowed to recover between dosings. Such a dosing system releases the pressurised effluent into the Leach Field with a timer (usually 3 to 4 times a day).

Design Considerations Each trench is 0.3 to 1.5 m deep and 0.3 to 1 m wide. The bottom of each trench is filled with about 15 cm of clean rock and a perforated distribution pipe is laid on top. More rock is placed to cover the pipe. A layer of geotextile fabric is placed on the rock layer to prevent small particles from plugging the pipe. A final layer of sand and/or topsoil covers the

fabric and fills the trench to the ground level. The pipe should be placed at least 15 cm beneath the surface to prevent effluent from surfacing. The trenches should be dug no longer than 20 m in length and at least 1 to 2 m apart. To prevent contamination, a leach field should be located at least 30 m away from any drinking water source. A Leach Field should be laid out such that it will not interfere with a future sewer connection. The collection technology which precedes the Leach Field (e.g. Septic Tank, S.3) should be equipped with a sewer connection so that if, or when, the leach field needs to be replaced, the changeover can be done with minimal disruption.

Appropriateness Leach Fields require a large area and unsaturated soil with good absorptive capacity to effectively dissipate the effluent. Due to potential oversaturation of the soil, Leach Fields are not appropriate for dense urban areas. They can be used in almost every temperature, although there may be problems with pooling effluent in areas where the ground freezes.

Homeowners who have a Leach Field must be aware of how it works and of their maintenance responsibilities. Trees and deep-rooted plants should be kept away from the Leach Field as they can crack and disturb the tile bed.

Health Aspects/Acceptance Since the technology is underground and requires little attention, users will rarely come in contact with the effluent and, therefore, it has no health risks. The Leach Field must be kept as far away as possible (at least 30 m) from any potential potable water source to avoid contamination.

Operation & Maintenance A Leach Field will become clogged over time, although this may take 20 or more years, if a well-maintained and well-functioning primary treatment technology is in place. Effectively, a Leach Field should require minimal maintenance; however, if the system stops working efficiently, the pipes should be cleaned and/or removed and replaced. To maintain the Leach Field, there should be no plants or trees on it. There should also be no heavy traffic above it because this could crush the pipes or compact the soil.

Pros & Cons

- + Can be used for the combined treatment and disposal of effluent
- + Has a long lifespan (depending on conditions)
- + Low maintenance requirements if operating without mechanical equipment
- + Relatively low capital costs; low operating costs
- Requires expert design and construction
- Not all parts and materials may be locally available
- Requires a large area
- Primary treatment is required to prevent clogging
- May negatively affect soil and groundwater properties

References & Further Reading

can be found on page 253

Application Level:

- Household
 Neighbourhood
 City

Management Level:

- Household
 Shared
 Public

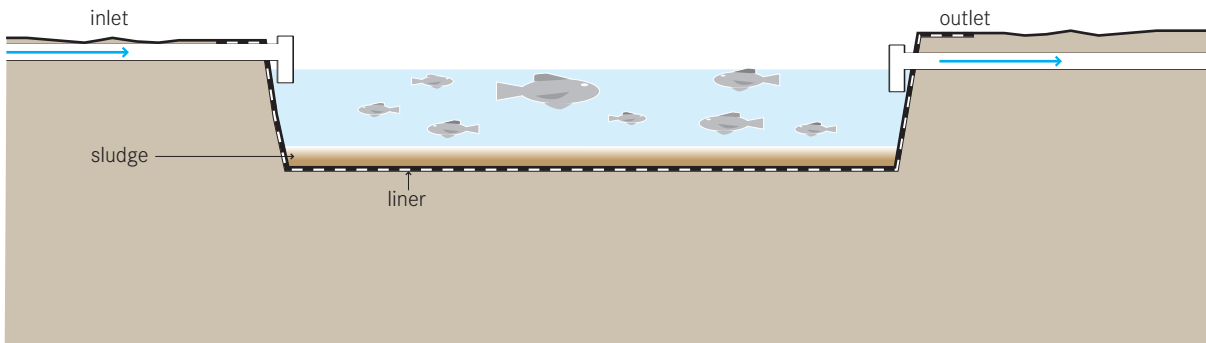
Inputs: Effluent**Outputs:** Biomass

Fish can be grown in ponds that receive effluent or sludge where they can feed on algae and other organisms that grow in the nutrient-rich water. The fish, thereby, remove the nutrients from the wastewater and are eventually harvested for consumption.

Three kinds of aquaculture designs for raising fish exist:

- 1) fertilisation of Fish Ponds with effluent;
- 2) fertilisation of Fish Ponds with excreta/sludge; and
- 3) fish grown directly in aerobic ponds (T.5 or T.6).

Fish introduced into aerobic ponds can effectively reduce algae and help control the mosquito population. It is also possible to combine fish and floating plants (R.8) in one single pond. The fish themselves do not dramatically improve the water quality, but because of their economic value they can offset the costs of operating a treatment facility. Under ideal operating conditions, up to 10,000 kg/ha of fish can be harvested. If the fish are not acceptable for human consumption, they can be a valuable source of protein for other high-value carnivores (like shrimp) or converted into fishmeal for pigs and chickens.

Design Considerations The design should be based on the quantity of nutrients to be removed, the nutrients required by the fish and the water requirements needed to ensure healthy living conditions (e.g. low ammonium levels, required water temperature, etc.). When introducing nutrients in the form of effluent or sludge, it is important to limit the additions so that aerobic conditions are maintained. BOD should not exceed 1 g/m²/d and oxygen should be at least 4 mg/L.

Only fish tolerant of low dissolved oxygen levels should be chosen. They should not be carnivores and they should be tolerant to diseases and adverse environmental conditions. Different varieties of carp, milkfish and tilapia have been successfully used, but the specific choice will depend on local preference and suitability.

Appropriateness A Fish Pond is only appropriate where there is a sufficient amount of land (or pre-existing pond), a source of freshwater and a suitable climate. The water used to dilute the waste should not be too warm and the ammonium levels should be kept low or negligible because of its toxicity to fish.

This technology is appropriate for warm or tropical climates with no freezing temperatures and preferably with high rainfall and minimal evaporation.

Health Aspects/Acceptance Where there is no other source of readily available protein, this technology may be embraced. The quality and condition of the fish will also influence local acceptance. There may be concern about contamination of the fish, especially when they are harvested, cleaned and prepared. If they are cooked well, they should be safe, but it is advisable to move the fish to a clear-water pond for several weeks before they are harvested for consumption. WHO guidelines on wastewater and excreta use in aquaculture should be consulted for detailed information and specific guidance.

Operation & Maintenance The fish need to be harvested when they reach an appropriate age/size. Sometimes after harvesting, the pond should be drained so that (a) it can be desludged and (b) it can be left to dry in the sun for 1 to 2 weeks to destroy any pathogens living on the bottom or sides of the pond. Workers should wear appropriate protective clothing.

Pros & Cons

- + Can provide a cheap, locally available protein source
- + Potential for local job creation and income generation
- + Relatively low capital costs; operating costs should be offset by production revenue
- + Can be built and maintained with locally available materials
- Requires abundance of fresh water
- Requires a large land (pond) area
- May require expert design and installation
- Fish may pose a health risk if improperly prepared or cooked
- Social acceptance may be low in some areas

References & Further Reading

can be found on page 253

Application Level:	Management Level:	Inputs: <input checked="" type="checkbox"/> Effluent
<input type="checkbox"/> Household	<input type="checkbox"/> Household	Outputs: <input checked="" type="checkbox"/> Biomass
<input checked="" type="checkbox"/> Neighbourhood	<input checked="" type="checkbox"/> Shared	
<input checked="" type="checkbox"/> City	<input checked="" type="checkbox"/> Public	

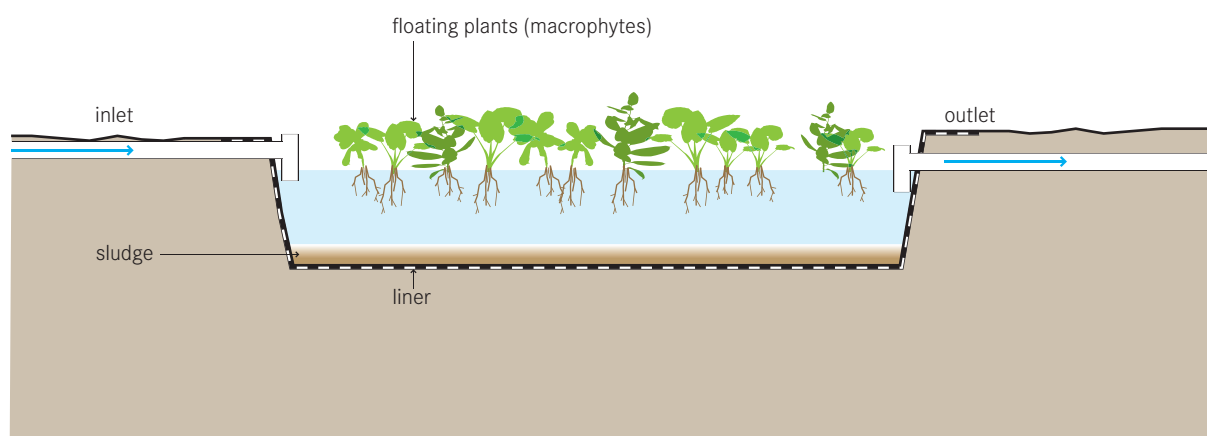

A Floating Plant Pond is a modified maturation pond with naturally floating (macrophyte) plants. Plants, such as water hyacinths or duckweed, float on the surface while the roots hang down into the water to uptake nutrients and filter the water that flows by.

This technology appears similar to the Floating Treatment Wetland (T.10), which works with artificially floating macrophytes. The essential difference is the lower oxygen production of the Floating Plant Pond - which is not the main priority, as wastewater treatment has taken place already.

Water hyacinths are perennial, freshwater, aquatic macrophytes that grow especially fast in wastewater. The plants can grow large: between 0.5 to 1.2 m from top to bottom. The long roots provide a fixed medium for bacteria which in turn degrade the organics in the water passing by.

Duckweed is a fast growing, high protein plant that can be used fresh or dried as a food for fish or poultry. It is tolerant of a variety of conditions and can significantly remove quantities of nutrients from wastewater.

Design Considerations Locally appropriate plants can be selected depending on their availability and the characteristics of the wastewater.

To provide extra oxygen to a floating plant technology, the water can be mechanically aerated, but at the cost of increased power and machinery. Aerated ponds can withstand higher loads and can be built with smaller footprints. Non-aerated ponds should not be too deep otherwise there will be insufficient contact between the bacteria-harboring roots and the wastewater.

Appropriateness A Floating Plant Pond is only appropriate when there is a sufficient amount of land (or pre-existing pond). It is appropriate for warm or tropical climates with no freezing temperatures and preferably with high rainfall and minimal evaporation. The technology can achieve high removal rates of both BOD and suspended solids, although pathogen removal is not substantial.

Harvested hyacinths can be used as a source of fibre for rope, textiles, baskets, etc. Depending on the income generated, the technology can be cost neutral. Duckweed can be used as the sole food source for some herbivorous fish.

Health Aspects/Acceptance Water hyacinth has attractive, lavender flowers. A well designed and maintained system can add value and interest to otherwise barren land. Adequate signage and fencing should be used to prevent people and animals from coming in contact with the water. Workers should wear appropriate protective clothing. WHO guidelines on wastewater and excreta use in aquaculture should be consulted for detailed information and specific guidance.

Operation & Maintenance Floating Plants require constant harvesting. The harvested biomass can be used for small artisanal businesses, or it can be composted. Mosquito problems can develop when the plants are not regularly harvested. Depending on the amount of solids that enter the pond, it must be periodically desludged. Trained staff are required to constantly operate and maintain it.

Pros & Cons

- + Water hyacinth grows rapidly and is attractive
- + Potential for local job creation and income generation
- + Relatively low capital costs; operating costs can be offset by revenue
- + High reduction of BOD and solids; low reduction of pathogens
- + Can be built and maintained with locally available materials
- Requires a large land (pond) area
- Some plants can become invasive species if released into natural environments

References & Further Reading

can be found on page 253

Application Level:

- Household
- Neighbourhood
- City

Management Level:

- Household
- Shared
- Public

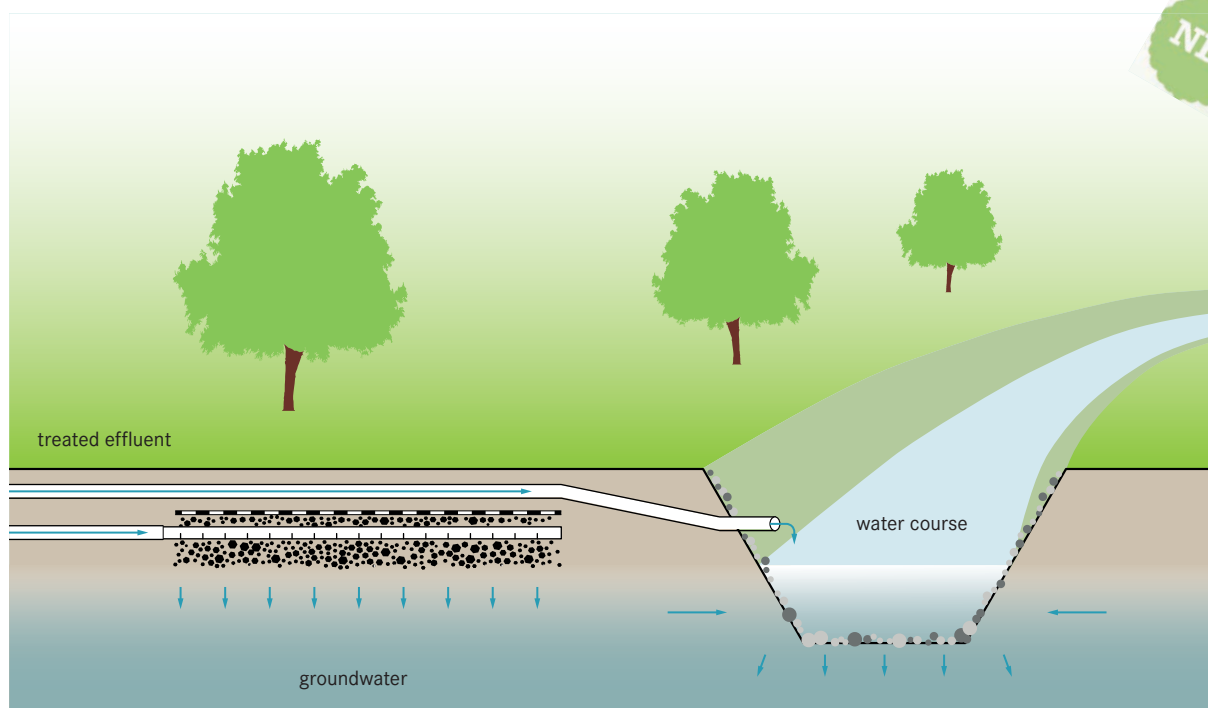
Inputs: Effluent Stormwater

Treated and quality-assured effluent and/or stormwater can be discharged into receiving water bodies (rivers, lakes, etc.) or directly into the ground to recharge aquifers. Both can be an important part of completing the water cycle. If not well monitored and managed, they pose serious risks and hazards of pollution that can lead to the opposite: reducing available drinking water resources and accelerating water insecurity. Both technologies have an important role in complementing other reuse technologies, such as irrigation, which may be limited to certain periods of the year.

Discharge into open water bodies also affects groundwater flow and water quality. The river or lake water mixed with the treated effluent in low concentrations infiltrates into the ground and recharges the groundwater. Since Riverbank Filtration (RBF) systems are typically used for drinking water production, controlling the quality and quantity of the discharged effluent is crucial to avoid contamination not only of surface water, but also of groundwater. If the effluent is discharged into the same water body

at several points, even stricter control of the effluent quality parameters is required.

Treated effluent can also be infiltrated into the ground by subsurface infiltration systems to recharge groundwater. Soil acts as a biologically active filter medium, with a number of factors, such as soil structure, infiltration rate and water storage capacity, biological activity and aquifer depth, playing a significant role. Groundwater recharge is increasing in popularity as groundwater resources deplete and as saltwater intrusion becomes a greater threat to coastal communities. Although the soil can be a very effective filter during certain periods of the year, it may not limit contamination especially when the groundwater level changes during the year. Therefore, Groundwater Recharge should not be viewed and implemented as a treatment method. Once an aquifer is contaminated, it is next to impossible to reclaim it.

Design Considerations It is necessary to ensure that the assimilation capacity of the receiving water body is not exceeded, i.e. that the receiving body can accept the quantity of nutrients without being overloaded. High nutrient concentrations in wastewater can lead to

eutrophication of the river or lake caused by exponential growth of algae and aquatic plants and their subsequent decomposition using up all available oxygen. This destroys all oxygen-dependent life in the water bodies. Parameters, such as turbidity, temperature, suspended solids, BOD, nitrogen and phosphorus (among others), should be carefully controlled and monitored before releasing any effluent into a natural water body.

Groundwater recharge by subsurface infiltration is successfully practised with drainage pipes laid in gravel beds. A geotextile is laid above the gravel bed to prevent soil infiltration. The quality of water extracted from a recharged aquifer is a function of the quality of the treated effluent introduced, the method of recharge, the characteristics of the aquifer, the residence time, the amount of blending with other waters and the history of the system. More aspects regarding the integrated management of groundwater and sanitation (X 2.1) and managed aquifer recharge (X 2.2) are discussed in Part 3 (pp.177-180).

Appropriateness The adequacy of discharge into a water body or aquifer will depend on the effluent quality parameters, the local environmental conditions and the legal regulations. These regulations might determine the required quality of the effluent, the allowed volume or flow rate to be discharged and the point and form of discharge. Generally, discharge to a water body is only appropriate when there is a safe distance between the discharge point and the next closest point of water extraction. Similarly, groundwater recharge is most appropriate for areas that are at risk of saltwater intrusion or aquifers that have a long retention time.

Health Aspects/Acceptance The discharge of treated wastewater into surface waters is subject to various restrictions, primarily legal but also those associated with the use of the waters. Discharge into waters that are used directly for drinking water production is usually not permitted. To avoid the health risks due to pathogen contamination of surface water bodies, the discharge of effluent should only be practised where pathogen concentrations can be regularly controlled. For especially sensitive areas, a post-treatment technology (e.g. UV-radiation, see POST, p. 116) may be required to meet microbiological limits. The risk of groundwater contamination through nitrogen (N) needs special attention when it is used as a drinking water source. In the form of nitrate (NO_3), it poses a health hazard (WHO

guidelines: : $\text{NO}_3 \leq 50 \text{ mg/L}$). Separating nitrogen from effluent requires tertiary treatment processes which are complicated and costly. Therefore, controlling N concentrations and the volume of effluent infiltrated is crucial.

Generally, cations (Mg_2^+ , K^+ , NH_4^+) and organic matter will be retained in a soil with higher lime and clay content, while other contaminants (such as nitrates) will remain in the water. There are numerous models for the remediation potential of contaminants and microorganisms, but predicting downstream or extracted water quality for a large suite of parameters is rarely feasible. Therefore, potable and non-potable water sources should be clearly identified, the most important parameters modelled and a risk assessment completed.

Operation & Maintenance Regular monitoring and sampling are important to ensure compliance with regulations and public health requirements. With regard to their infiltration capacity, the discharge of effluent into lakes or riverbeds generally has no influence. However, subsurface infiltration systems have to be carefully monitored to prevent infiltration rates from decreasing due to clogging of the soil structure and the systems from becoming increasingly unusable. Clogging (physical, chemical and/or micro-biological) of infiltration/percolation surfaces, caused in particular by infiltration of poor quality effluent, can drastically reduce infiltration rates and, thus, the volume of effluent that can be used for recharge. This is also the main long-term maintenance issue. Measures to reduce clogging through pre-treatment and maintenance of the systems are well documented.

Pros & Cons

- + Contribution to balancing groundwater abstraction and regeneration
- + May increase productivity of water bodies by maintaining constant levels
- + Possibility to stabilise or freshening of brackish or rising salinity groundwater
- Discharge of nutrients and micropollutants may affect natural water bodies and/or drinking water
- Introduction of pollutants may have long-term impacts quality
- May negatively affect soil and groundwater properties

References & Further Reading

can be found on page 254

<p>Application Level:</p> <ul style="list-style-type: none"> <input type="checkbox"/> Household <input type="checkbox"/> Neighbourhood <input type="checkbox"/> City 	<p>Management Level:</p> <ul style="list-style-type: none"> <input type="checkbox"/> Household <input type="checkbox"/> Shared <input type="checkbox"/> Public 	<p>Inputs:</p> <ul style="list-style-type: none"> <input type="checkbox"/> Sludge <input type="checkbox"/> Pit Humus <input type="checkbox"/> Compost <input type="checkbox"/> Compost <input type="checkbox"/> Dried faeces <input type="checkbox"/> Dry Cleansing Materials <input type="checkbox"/> Pre-Treatment Products
--	--	---

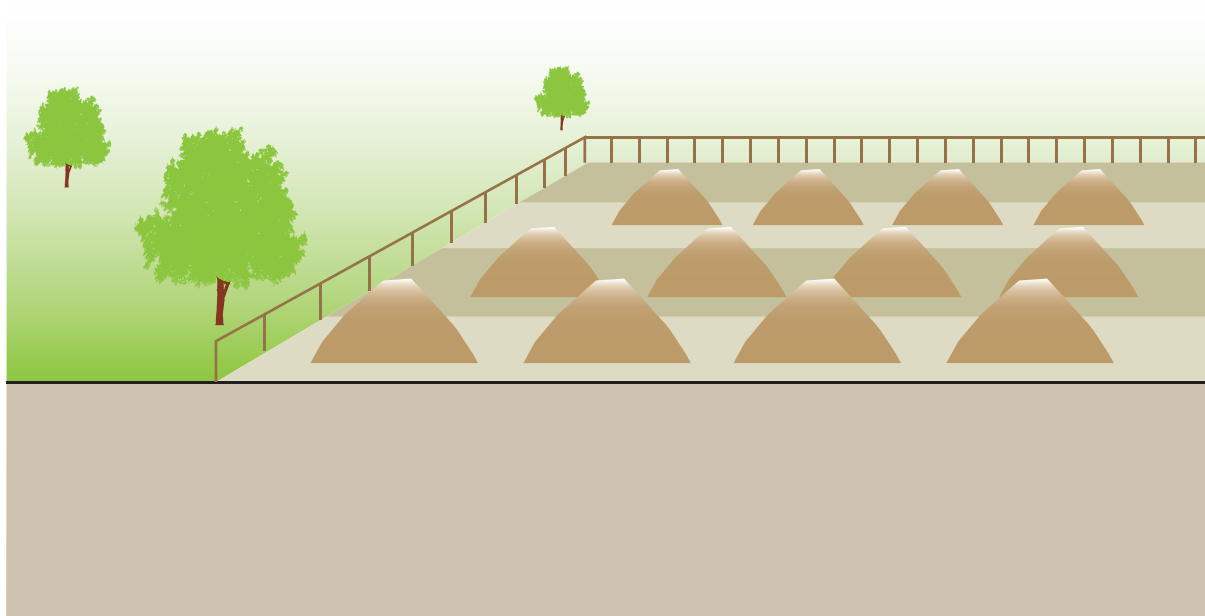

Surface Disposal refers to the stockpiling of sludge, faeces or other materials that cannot be used elsewhere. Once the material has been taken to a surface disposal site, it is not used later. **Storage** refers to temporary stockpiling. It can be done when there is no immediate need for the material and a future use is anticipated, or when further pathogen reduction and drying is desired before application.

This technology is primarily used for sludge, although it is applicable to any type of dry, unusable material. One application of surface disposal is the disposal of dry cleansing materials, such as toilet paper, corn cobs, stones, newspaper and/or leaves. These materials cannot always be included along with other water-based products in some technologies and must be separated. A rubbish bin should be provided beside the User Interface to collect the cleansing materials and menstrual hygiene materials. Dry materials can be burned (e.g. corn cobs) or disposed of along with the household waste. For simplicity, the remainder of this technology information sheet will be dedicated to sludge since standard solid waste practises are beyond

the scope of this Compendium.

When there is no demand for or acceptance of the beneficial use of sludge, it can be placed in monofills (sludge-only landfills) or heaped into permanent piles. Temporary storage contributes to further dehydration of the product and the die-off of pathogens before it is used.

Design Considerations Landfilling sludge along with municipal solid waste (MSW) is not advisable since it reduces the life of a landfill, which has been specifically designed for the containment of more noxious materials. As opposed to more centralised MSW landfills, surface disposal sites can be situated close to where the sludge is treated, limiting the need for long transport distances.

The main difference between surface disposal and land application is the application rate. There is no limit to the quantity of sludge that can be applied to the surface since nutrient loads or agronomic rates are not a concern. Attention must be paid, however, to groundwater contamination and leaching. More advanced surface disposal systems may incorporate a liner and leachate collection system in order to

prevent nutrients and contaminants from infiltrating the groundwater. Sites for the temporary storage of a product should be covered to avoid rewetting by rainwater and the generation of leachate.

Appropriateness Since there are no benefits gained from surface disposal, it should not be considered as a primary option. However, where sludge use is not easily accepted, the contained and controlled stockpiling of solids is far preferable to uncontrolled dumping. Storage may, in some cases, be a good option to further dry and sanitise the material and to generate a safe, acceptable product. Storage may also be required to bridge the gap between supply and demand. Surface disposal and storage can be practised in almost every climate and environment, although they may not be feasible where there is frequent flooding or where the groundwater table is high.

Health Aspects/Acceptance If a Surface Disposal and Storage site is protected (e.g. by a fence) and located far from the public, there should be no risk of contact or nuisance. The contamination of groundwater resources by leachate should be prevented by adequate siting and design. Care should be taken to protect the disposal or storage site from vermin and pooling water, both of which could exacerbate smell and vector problems.

Operation & Maintenance Staff should ensure that only appropriate materials are disposed of at the site and must maintain control over the traffic and hours of operation. Workers should wear appropriate protective clothing.

Pros & Cons

- + May prevent unmitigated disposal
- + Storage may render the product more hygienic
- + Can make use of vacant or abandoned land
- + Little operation skills or maintenance required
- + Low capital and operating costs
- Requires a large land area
- Potential leaching of nutrients and contaminants into groundwater
- Surface disposal hampers the beneficial use of a resource
- Odours may be noticeable, depending on prior treatment
- May require special spreading equipment

References & Further Reading

can be found on page 254

Application Level:	Management Level:	Inputs:  Biogas
<input type="checkbox"/> * Household <input checked="" type="checkbox"/> ** Neighbourhood <input type="checkbox"/> City	<input checked="" type="checkbox"/> ** Household <input checked="" type="checkbox"/> ** Shared <input checked="" type="checkbox"/> ** Public	Outputs: Heat energy, Light

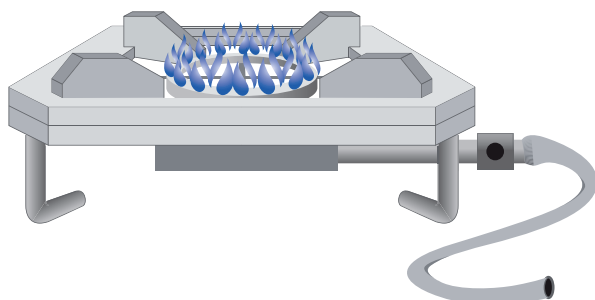

In principal, biogas can be used like other fuel gas. When produced in household-level biogas reactors, it is most suitable for cooking. Additionally, electricity generation is a valuable option when the biogas is produced in large anaerobic digesters.

Household energy demand varies greatly and is influenced by cooking and eating habits (i.e. hard grains and maize may require substantial cooking times; and therefore, more energy compared to cooking fresh vegetables and meat). Biogas has an average methane content of 55-75%, which implies an energy content of 6-6.5 kWh/ m³.

Design Considerations Gas demand can be defined on the basis of energy previously consumed. For example, 1 kg firewood roughly corresponds to 200 L biogas, 1 kg dried cow dung corresponds to 100 L biogas and 1 kg charcoal corresponds to 500 L biogas. Gas consumption for cooking per person and per meal is between 150 and 300 L biogas. Approximately 30-40 L biogas is required to cook one litre of water, 120-140 L for 0.5 kg rice and 160-190 L for 0.5 kg vegetables. Tests have shown that the consumption rate of a

household biogas stove is about 300-400 L/h. However, this depends on the stove design and the methane content of the biogas. The following consumption rates in litres per hour (L/h) can be assumed for the use of biogas:

- household burners: 200-450 L/h
- industrial burners: 1 000-3 000 L/h
- refrigerator (100L) depending on outside temperature: 30-75 L/h
- gas lamp, equivalent to a 60 W bulb: 120- 150 L/h
- biogas/diesel engine per bhp: 420 L/h
- generation of 1 kWh of electricity with biogas/diesel mixture: 700 L/h

Compared to other gases, biogas needs less air for combustion. Therefore, conventional gas appliances need to be modified when they are used for Biogas Combustion (e.g. larger gas jets and burner holes). The distance through which the gas must travel should be minimised since losses and leakages may occur. As explained in T.18, drip valves should be installed for the drainage of condensed water, which accumulates at the lowest points of the gas pipe.

Appropriateness The calorific efficiency of using biogas is 55% in stoves, 24% in engines, but only 3% in lamps. A biogas lamp is only half as efficient as a kerosene lamp. The most efficient way of using biogas is in a heat-power combination where 88% efficiency can be reached. But, this is only valid for larger installations and under the condition that the exhaust heat is profitably used. For household applications, the best way to use biogas is for cooking.

Health Aspects/Acceptance In general, users enjoy cooking with biogas as it can immediately be switched on and off (as compared to wood and coal). Also, it burns without smoke; and thus, does not lead to indoor air pollution. Biogas generated from faeces may not be appropriate in all cultural contexts. Assuming that the biogas plant is well-constructed, operated and maintained (e.g. water is drained), the risk of leaks, explosions or any other threats to human health is negligible.

Operation & Maintenance Biogas is usually fully saturated with water vapour, which leads to condensation. To prevent blocking and corrosion, the accumulated

water has to be periodically emptied from the installed water traps. Trained personnel must regularly monitor the gas pipelines, fittings and appliances.

When using biogas for an engine, it is necessary to first reduce the hydrogen sulphide because it forms corrosive acids when combined with condensing water.



The reduction of the carbon-dioxide content requires additional operational and financial efforts. When biogas is used for cooking, CO₂ “scrubbing” is not necessary.

Pros & Cons

- + Free source of energy
- + Reduction of indoor air pollution and deforestation (if firewood or coal was previously used)
- + Little operation skills or maintenance required
- May not fulfil total energy requirements
- Cannot replace all types of energy
- Cannot be easily stored (low energy density per volume) and, thus, needs to be continuously used

References & Further Reading

can be found on page 254

Application Level:	Management Level:	Inputs:  Biochar
<input type="checkbox"/> * Household	<input type="checkbox"/> * Household	Outputs:  Biomass
<input type="checkbox"/> * Neighbourhood	<input type="checkbox"/> ** Shared	
<input type="checkbox"/> ** City	<input type="checkbox"/> ** Public	

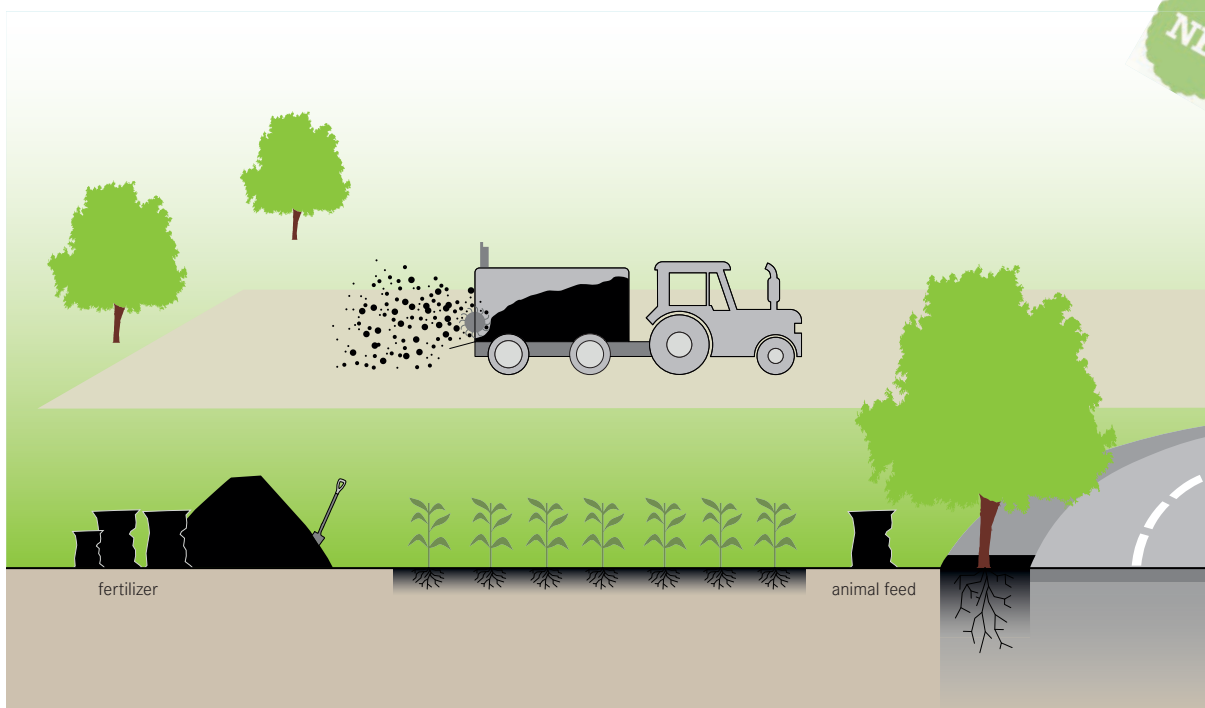

Biochar is a solid material obtained from carbonisation, the thermochemical conversion of biomass in an oxygen-limited environment. Biochar derived from the carbonisation of sludge, faeces and/or organic waste may be applied to soils to improve soil properties and crop yields, and act as a carbon sink to reduce climate change impacts.

Other applications include use as an adsorption material for filters, especially for water purification purposes, or as an additive to filling and building materials. It can be used as an additive in silage processing or mixed directly into the feed of livestock. As a substitute for fossil fuels, biochar improves the CO₂ footprint in energy conversion. It is typically called “biochar” when used as a soil conditioner and “char” when it is used as a fuel.

Design Considerations Biochar is black, lightweight, highly porous and alkaline in nature due to its ash content. It has a high carbon content, which gives it a similar energy value to coal or charcoal. The quality and characteristics of the organic material used, as well as the conditions under which carbonisation takes place, have a major influence on the properties of

the biochar produced and consequently on its suitability for the various uses.

Appropriateness Biochar has a broad range of applications in agriculture, forestry, energy generation and fertiliser production. When used as a soil conditioner, the high carbon content of biochar increases carbon sequestration in the soil, i.e. storage over a long period of time. A possible future benefit of long-term carbon storage in soils is the option for tradable carbon certificates that could considerably reduce the cost of biochar.

Due to its high porosity and large surface area, biochar is used as a treatment filter and for soil conditioning. As a filter, biochar removes pollutants from water through the process of adsorption. The large surface area and porosity provide many reactive sites for the attachment of dissolved compounds in contaminated water. The affinity for adsorption of pollutants in the soil, such as heavy metals, but also organic pollutants, can prevent them from being taken up by plants.

Biochar increases the formation and stabilisation of microaggregates in the soil and has a high porosity and surface area, which results in a high retention and

sorption capacity for nutrients. The binding of N in the soil takes place largely in plant-available form, whereby possible leaching of N in the form of NO_3 is reduced. The availability of other important nutrients, such as P and K, tends to increase. The exact impact of biochar application on soil fertility also depends on other factors, including application patterns (e.g. application rate, size of biochar and management practices), soil characteristics and environmental conditions.

The interest in biochar is increasing for admixture in planting substrates for trees and shrubs in the context of urban greening, with surprising results in terms of drought and pollutant resistance. In horticulture, biochar can partly or completely replace the planting substrate. As an additive to construction materials, e.g. in concrete mixes, biochar enables a carbon sink that significantly improves the carbon balance. Another possible use is in road construction as an additive to asphalt. When used for energy conversion, it can be directly substituted for any application that uses coal or charcoal.

Health Aspects/Acceptance Contaminants in the carbonised substrate (e.g. sludge), such as organic pollutants, insecticides and pesticides, as well as pathogens, are catalytically or thermally destroyed in advanced production processes of biochar. Biochar is therefore a safe product. In addition, the remaining heavy metals in the biochar are speciated as insoluble sulphides and should not be available for uptake by plants, making biochar safe for use in agriculture. However, dust arising from the initial application of biochar can pose a risk for respiratory diseases. Face masks should be worn when handling biochar.

Research and development around carbonisation over the last 15 years has demonstrated the importance and possibilities of this technology and its product, biochar. There seem to not be any social barriers to its use, but since awareness of this product and the availability of biochar are still low, its use is not yet widespread. However, its properties and wide range of applications make it a promising product, especially for the use of biochar from sewage sludge in agriculture. Only more widespread application and dissemination of advanced carbonisation technology, combined with capacity

building, will make it possible to realise all the benefits for potential users of biochar.

Operation & Maintenance Biochar can be stored in bags in dry places. It can be used in agriculture in the same way as compost or solid manure and can be incorporated into the soil. For application with a manure spreader, it must be mixed with other organic materials, such as compost. When used as a filter material, the biochar must be replaced regularly depending on the filter size and flow rate. Used filter material must be properly treated or disposed of.

Pros & Cons

- + Biochar can improve the soil quality and the biological and chemical structure of soil
- + Application of biochar on soil is a means of increasing its carbon storage. The long storage period of biochar C in the soil makes it a carbon sink, compensating the effect of anthropogenic CO_2 emissions
- + Because of its high surface-to-volume ratio and strong affinity to non-polar substances, biochar has the potential to adsorb a variety of organic pollutants and heavy metals from water and the soil
- + Biochar has a liming effect which can be used to balance acidic soil towards a neutral pH
- + The high sorption and retention capacity avoids nutrient leaching but the form of binding has generally no negative effect on the availability and uptake by the plants
- Under some conditions, however, yields may decline because of the absorption of water and nutrients by the biochar, which reduces the availability of these resources for the crops
- Dust arising from the initial application of biochar can pose a risk for respiratory diseases
- When pesticides and herbicides are applied, the sorption capacity of biochar can reduce their efficacy
- Nitrogen is lost from the biomass in the production of biochar

References & Further Reading

can be found on page 255

In addition to the established and proven technologies presented in Part 2 of this Compendium, numerous innovative sanitation technologies are being researched, developed and tested in the field. Emerging technologies are those that have moved beyond the laboratory and small-pilot phase and are currently (as of March 2022) being implemented in relevant contexts (i.e. in a developing country or emerging economy) and at a scale that indicates that expansion is possible (i.e. not a single unit).

Since the last edition of the Compendium (2014), the collective action and investments by actors, such as the Bill & Melinda Gates Foundation, the City Wide Inclusive Sanitation Global Initiative, the Sanitation and Hygiene Fund, regional and national champions, e.g. the South African Water Research Commission along with such alliances as the Sustainable Sanitation Alliance, the Faecal Sludge Management Alliance and many more, have continued to accelerate visibility, political will, innovation and knowledge in the form of a steadily growing number of peer reviewed publications, most of them open source.

While a number of innovations have made it into the section of proven technologies in Part 2 of this Compendium or are ready featured in the Sanitation Resource Recovery Guide (p. 10), many more promising technologies are under research and development.

This section focuses on three promising developments that have emerged from the above initiatives and that are ready for commercialisation in the Wider Caribbean Region:

1. WeCo Autonomous Flush Toilet, France

Based on the urgent need for non-networked solutions, new technologies have been developed, adapted and field-tested along with the development of the new industry standard ISO 30500 (pp. 174-176). One of these solutions, integrating several innovations into a mobile, compact and autonomous flush-water sanitation solution, is featured in the form of a case study, following the same structure as other case studies presented in Part 4 of this Compendium.

2. SASTEP Innovation Platform, South Africa

The South African Sanitation Technology Enterprise Programme, is an innovation platform that seeks to fast-track the adoption of innovative and emerging sanitation technologies in South Africa through fostering local manufacturing and commercialisation. The core strategy of the programme includes supporting and empowering sanitation innovators (technology partners) and sanitation entrepreneurs (commercial partners) through the formation of collaborative partnerships. Three of these innovations with potential for the Wider Caribbean Region are presented:

- 2.1. Envirosan Eazisplit
(reflected in U.3, Part 2 of this Compendium)
- 2.2. Enviro Options Clear Recirculating Toilet
- 2.3. LiquidGold Diamond Reactor

3. SCG Zyclone Cube, Thailand

Among the various “Reinvented Toilet Technologies in Development” presented on the American National Standard Institute’s website dedicated to “ISO Non-Sewered Sanitation Standards”, a prefabricated treatment solution available from a large manufacturer in Thailand has been selected because of its modularity and ability to improve the effluent of septic tanks in terms of organic load and pathogen removal.

References & Further Reading

can be found on page 255

Emerging Technologies Case Study: Combining Autonomy and Circularity – Non-Sewered Flush Toilets by WeCo, France



General aspects This sanitation system offers an innovative, mobile, compact and autonomous solution for sanitation with conventional flush toilets. The black water is recycled in a closed loop into hygienically safe water that is reused for flushing. Therefore, neither a connection to the sewer network, nor a drinking water connection, are required for toilet flushing. In remote locations, energy needs can be met by rooftop solar power, ensuring safe functioning even without a grid connection.

The treatment technologies have emerged from initiatives to develop reliable non-sewered sanitation systems by cutting the sanitation service chain at the containment stage, therefore, eliminating the emptying and transportation stages and with treatment performed onsite (see Cross-Cutting Issues X 1.2.2 Figure 1, p. 176: ISO 30500 product standard).

The sanitation system was developed using criteria that led to the selection and adaptation of the most suitable technologies. Table 1 shows a selection of the criteria and the technology chosen for each.

Planning process The planning starts with a detailed demand analysis and the proper determination of the required capacity of the toilet unit. Since no connection to the sewer and water network is required, further planning for this type of system is simple. At some sites, direct discharge or infiltration of the excess water is not authorised, so it must be emptied and transported every three to six months. The entire system is shown in Figure 1.

Tab. 1: Technology choice according to selected criteria

Criteria	Technology chosen
Wastewater with relatively high concentrations of organic matter (black water from toilets). Energy consumption by the secondary treatment stage	Anaerobic treatment based on an anaerobic compartmentalised reactor (ABR), adapted and developed by WeCo.
Reuse of recycled water in flushes	Total disinfection must be ensured, which is why electrolysis was chosen
Mobile system	Small versions of technologies had to be developed

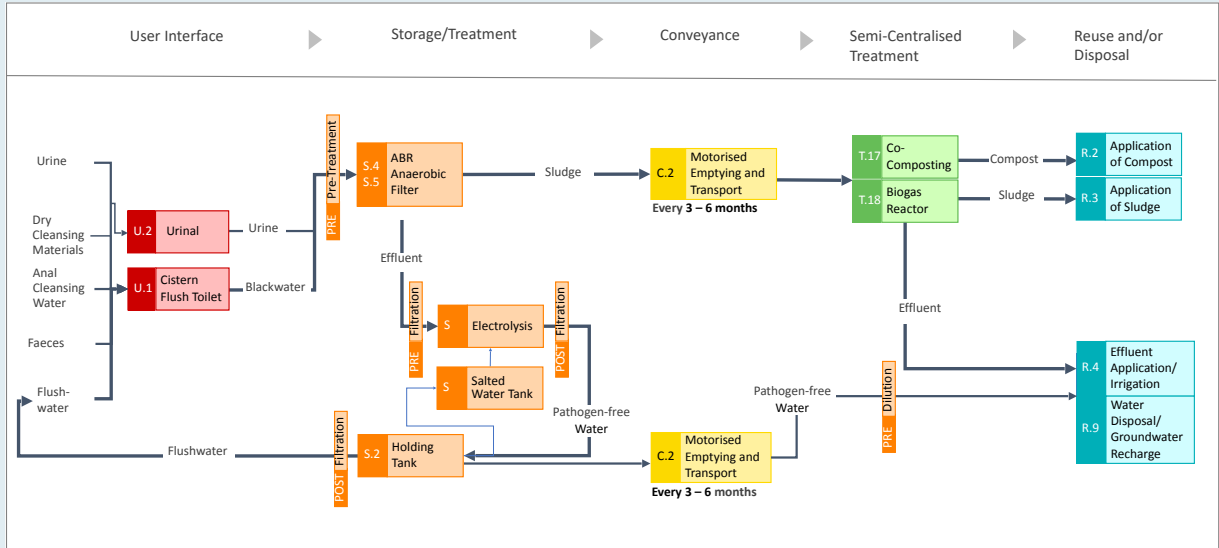

Figure 1: System Diagram

System design The system is based on the combination of a sedimentation and anaerobic digestion phase followed by an electro-chlorination step. The anaerobic digestion takes place in a bioreactor built as a hybrid settler-cum-ABR (S.4) and Anaerobic Filter (S.5). It serves as primary and secondary treatment to remove a large part of the dissolved organic matter and suspended solids. In the second step, electro-chlorination takes place in a mixed batch electro-chemical reactor, containing a stack of titanium-ruthenium-iron-oxide anodes and stainless-steel cathodes and achieves complete disinfection and complete elimination of ammonium. The bioreactor needs periodic emptying (every 3 to 6 months) which should preferably be done by Motorised Emptying and Transport (C.2). Due to the closed water cycle, salts accumulate in the sludge, which is why reuse in agriculture is only recommended after anaerobic digestion (T.18) or Co-Composting (T.17) with other organic materials. Direct reuse is not recommended.

Due to the continuous intake of urine, the system produces more water than it consumes. Like the sludge, the excess water also contains salt concentrations that require dilution before reuse in Application of Effluent/Irrigation (R.4). Direct discharge (R.9) may be restricted.

Treatment efficiency Research results from the California Institute of Technology, which first started to develop the technology (Cid and Hoffmann, 2018), prove that all bacteria are completely destroyed during electrolysis. To determine the treatment efficiency of the WeCo system, a series of monitoring campaigns were carried out by the WeCo team and measurements were realised by Eurofins, an external laboratory with expertise in water analysis. Some results are shown in Table 3.

All pathogens are destroyed as long as the electrochemical cycles are not interrupted and have a value of more than 810 mV (oxido-reduction potential) for more than three minutes. This is always the case, as

Tab. 2: Sistema modular con diferentes opciones según la asistencia y el espacio disponible

Tecnología	Stand-Alone	Contenedor P10	P20	G40
Tamaño	2 m ²	7 m ²	14 m ²	30 m ²
Asistencia (usuario por día)	60-120	60	150	300
Vaciado de lodos y exceso de agua	1/3 meses	1/6 meses	1/6 meses	1/6 meses

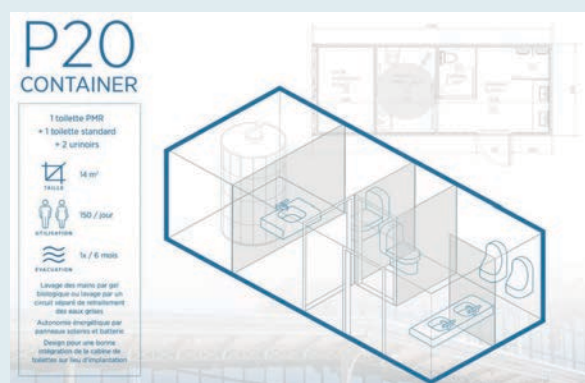
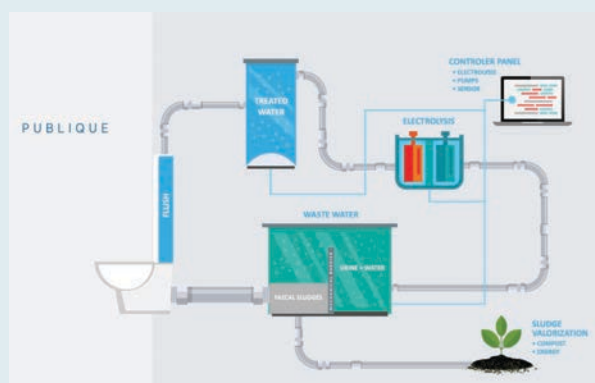

Figure 2 and 3: Treatment train and structure of the WeCo Toilet

the data in Figure 4 below shows. It can be clearly seen that the value of 810 mV is reached systematically and quickly during each cycle. According to these results, the water leaving the electrolyser is free of all pathogens. To prevent microbial growth during storage, the reaction time is extended to introduce additional residual chlorine into the circuit.

In the electrolysis process, elementary nitrogen is produced and released, drastically reducing the nitrogen content in the water, which constitutes another safeguard against the proliferation of pathogens during the storage phase.

The closed water loop provides significant water savings and requires excess water to be discharged only at 3 to 6 months intervals. The same applies to the draining of sludge. The system requires regular refilling of salt to maintain the process. Table 4 shows the salt requirements of the various system units and their energy consumption.

Institutional and regulatory aspects for non-sewered sanitation systems WeCo works together with local authorities where the first sanitation units are located. In France, local authorities are also involved in monitoring the water quality in the closed circuit. Soil infiltration of excess water in the immediate vicinity of the facilities is not allowed.

To simplify approval processes, WeCo collaborated in the development of the ISO 30500 industry standard, along with experts from 48 countries, representing industry, government, academia and non-governmental organisations (NGOs).

Tab. 3: Microbiological parameters after two hours of batch treatment

Microbiological parameters	Results	Unity
Intestinal enterococcus	0	Ufc/ 100ml
Coliform bacteria	0	Ufc/ 100ml
Escherichia coli	0	Ufc/ 100ml

Tab. 4: Water savings and consumption of salt and electricity (Measurements WeCo)

Parameter	Stand-alone	P10	P20	G40
Water Saving per year (m ³)	262.8	131.4	328.5	657
Electricity consumption (MWh)	8.4	4.2	10.5	21
Salt consumption (Kg/yr)	340	170	427	854
Filter cartridges (unity per year)	4	2	2	4

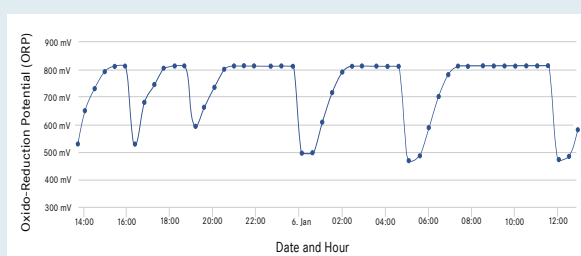

Figure 4: Evolution of Oxido-reduction potential over time. Each system monitors some physico-chemical parameters continuously. (Source: Paris WeCo site online monitoring, January 2022)

Regulators and policy makers, by nationally adopting the standard, can rely on global expert opinion and third-party certification to ensure safety of the product for its citizens without spending their own time and money. Twenty-six countries have already adopted the ISO 30500, including France, U.S., Mauritius, Seychelles, South Africa and Bangladesh. Having designed its system according to the standard, WeCo is preparing to start the ISO 30500 certification process (see Cross-Cutting Issues X 1.2.2, pp. 174-176).

Operation and maintenance Operation of the sanitation unit is in the hands of the institution or private contractor that ordered the unit. This operation includes the daily cleaning, the regular refill of salt, the discharge of excess water and the regular drainage of sludge and its transport to treatment facilities (every 3-6 month). After special training, the local technicians can perform regular maintenance tasks and simple repair work on stand-alone technology units, as well as containerised models. Commissioning of the units and complex maintenance tasks are the responsibility of the WeCo team. Special software helps to monitor and control the units.



Financial aspects The current investment cost for a stand-alone technology unit is \$35 000 and the cost for a complete P-20 size container unit is \$70 000. Operation and maintenance costs are approximately \$5 000 per year, including customer operating costs, maintenance work by local technicians and monitoring and special maintenance by the WeCo team. The investment cost is expected to be \$20 500 if production can be taken to an industrialisation phase with higher production output.

The lifetime of the system is expected to be about 20 years. Based on the actual investment cost of \$70 000 for a P-20 unit with an average attendance

of 150 users per day and operation and maintenance cost of \$5 000, the overall cost for the clients per year is \$8 500 (not including financial costs). With roughly 55 000 users per year the cost per user will be less than 20 cents.

An additional benefit is the saving of drinking water due to the recycling of 97% of the water for toilet flushing. About 10 m³ of treated water is produced each year due to the urine processing and recycling of its water content.

Success/failure factors and lessons learned

The experience gained from operating the equipment under real conditions led to the development of automatic cleaning functions for the electrodes to extend their service life. The operating software was further developed to improve the addition of salt.

The installation of units in the Paris Region is considered a success, as it provides a reliable sanitation service without complex installation requirements and the need for labour intensive operation. More than 3,5 m³ of water could be saved each month.

Challenges The treatment system is limited by the electrolysis phase, which runs in 2-hour batches. Therefore, one challenge will be to reduce the time required for electro-chemical treatment. One way to achieve this is to optimise the biological treatment in order to eliminate a maximum amount of dissolved organic matter in the first stage. However, this objective has its own challenges: the slow anaerobic degradation at ambient temperatures in cool climates and inhibition by the presence and accumulation of salts (and ammonia or chlorination by-products in the event of a malfunction).

Electro-oxidation is also the phase that requires the most energy. If this can be minimised, this will make a major contribution on the way to energy autonomy. By using photovoltaic solar energy, the improved system no longer relies on electricity from the grid. Another challenge to be addressed now is the industrialisation of the system to reduce the size of the treatment solution, limit its cost and improve its robustness. A final challenge is to improve the recovery of nutrients, particularly phosphorus, which can precipitate during electrolysis and for which a method of recovery from the system needs to be investigated.

References & Further Reading

can be found on page 256

Innovations from SASTEP, applicable for the Wider Caribbean Region

Substantial efforts and resources have been invested in the SASTEP innovation platform, seeking to fast-track the adoption of innovative and emerging sanitation technologies in South Africa through fostering local manufacturing and commercialisation.

The following three technologies have been selected:

1. **Envirosan Eazisplit** - a hybrid low-flush urine diversion toilet (U.3)
2. **Enviro Options Clear** - an autonomous flush toilet facility (U.1+U.2+S)
3. **LiquidGold Diamond Reactor** - a urine-to-struvite nutrient recovery reactor

As for the autonomous, non-sewered flush toilet system presented in the previous section, two of the three innovative technologies tested in the SASTEP programme and presented in this section emerged from the “Reinvent the Toilet Challenge” programme.

In February 2011, The Bill & Melinda Gates Foundation announced a major challenge to universities and other research organisations to “Reinvent the Toilet”. The aim was to develop innovative next-generation sanitation technologies that were on-site or decentralised, where water, energy and nutrients were recovered and reused and which were suitable for regions that are “flood-prone, or land, water, or money-poor”. Sanitation has diversified beyond sewers, giving people and cities flexible new options for decentralised or on-site sanitation systems. The vision behind the “Reinvented Toilets” was for toilets to be installed anywhere, including in crowded urban areas and that they would be operating “off the grid” at less than \$ 0.05 per user per day, remove pathogens and allow for the recovery of valuable resources, such as water, nutrients and energy (Sindall, 2020).

For further information and contacts to manufacturers: akina@wrc.org.za (Mr. Akin Akinsete)

1. Envirosan Eazisplit



Figure 1: Handing over of Eazisplit toilet

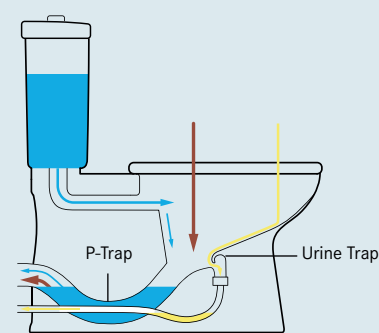
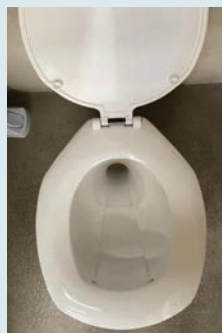

Figure 2 & 3: Eazisplit top view and cross-section

The Envirosan Eazisplit is a hybrid low flush urine diversion sanitation technology based upon the EOOS UDFT design (U.3) and developed as part of the “Reinvent the Toilet Challenge”. As a pour flush (Still, 2014), the Eazisplit solution is entirely off-grid and does not require a water supply. It flushes manually, with as little as 2 L of grey or potable water, whilst maintaining a 70-80 % urine split. The Eazisplit system can be upgraded to work with an internal or external

cistern (still flushing as little as 2 L of water). The urine is separately collected and can be stored or treated for further use as a fertiliser (e.g. LiquidGold Diamond Reactor). The urine diversion technology was further developed to better adapt to the context of emerging economies (water efficient, robust and pour flush). This resulted in a joint patent between EOOS Design GmbH and Enviromould Product Solutions (Pty) Ltd. Moreover, the unit is equipped with Envirosan’s already patented

and design-protected “P-Trap” water seal (Bhagwan 2014). This sanitation solution has the potential to be commercially viable throughout emerging economies, offering important co-benefits, such as the creation of jobs, the transfer of skills and education.

Considerations: Hybrid pour or low flush toilet with urine diversion for rural, periurban and urban settlements (U.3). Made of polypropylene, it is far less expensive than comparable toilets made of porcelain.

2. Enviro Options Clear Recirculating Toilet



Figure 4: Recirculating toilet block TT-5B

The Clear Recirculating Toilet System uses a full water cycling process for treatment of the blackwater. The Model TT-5B is a 4-seater toilet, designed to accommodate an average of 600 uses a day. It is a containerised and modular unit that is easy to transport, install and commission. It requires no connection to an existing sewer system and can be energy self-sufficient if connected to solar panels. It offers an off-grid solution and will work in areas with little water supply. The user interfaces are (U.1) cistern flush toilets. The on-site treatment uses (T.1) a settler followed by an “aerobic reactor” with proprietary bacteria and a membrane bioreactor (MBR). An ultraviolet (UV) system (POST) ensures disinfection of the recovered water stream before it is recycled for flushing. **This autonomous facility is comparable to the container solution by WeCo, France introduced in the previous section, using a different treatment technology.** The system has been licensed from Clear Environmental Technologies Co. Ltd (Suzhou/China) and is manufactured by Enviro Options, a South African dry sanitation company with over 26 years of experience in manufacturing and supplying safe, off-the-grid, non-sewered sanitation.

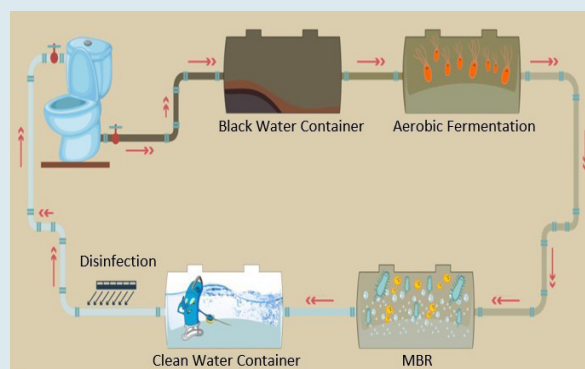

Figure 5: Treatment process including a Biofilm-MBR

Considerations: This non-sewered, autonomous technology can be used in rural, peri urban and urban settings for households, informal settlements and schools. It requires power to operate (Solar or on the grid).

In addition, there is also the model **TT-6** that houses the **treatment plant only**. This containerised unit has a much higher treatment capacity (around 6 000 uses a day) and **can be coupled to existing toilet blocks or small tourist resorts**, which makes it more versatile than the model TT-5B.

3. LiquidGold Diamond Reactor



Figure 6: Diamond Reactor mobile unit

LiquidGold Diamond is an automated nutrient recovery reactor that helps save on chemical and waste disposal costs, while creating a new revenue stream through the sale of high value recovered fertiliser. Precipitation of struvite is a well-known process for recovering phosphorus from urine (“Guide to Sanitation Resource Recovery”, p. 78). The precipitation process produces solid struvite from the urine solution during a chemical reaction. The reaction is initiated by adding a soluble magnesium source (e.g. magnesium, salts such as magnesium chloride or magnesium oxide, or a waste product like bittern). Nearly all the phosphorus from stored urine can be precipitated. Although struvite also contains ammonia, its precipitation is predominantly a phosphorus recovery process because less than 4 % of the ammonia in urine is recovered. After the addition of magnesium, struvite crystals form quickly and only slight over-dosages are required for complete precipitation of all the phosphorus.

This industrial scale urine to struvite plant is the first of its kind in South Africa. The unit offers the opportunity

to close the nutrient cycle, which is an authentic sanitation circular economy innovation. The inventor has secured an off-take agreement for the sale of 80 tonnes of struvite per year.

Considerations: Collecting urine with (U.2) urinals and urine diversion toilets (U.3 and U.4) offers various advantages: because wastewater treatment plants now receive a much smaller nutrient load, their footprint can become much smaller, while at the same time water bodies could be more effectively protected from nitrogen and phosphorus inputs. Moreover, the nutrients become available for recycling with reactors, such as the LiquidGold Diamond Reactor. It is appropriate for rural, peri urban and urban settings. Completely automated, off-grid and with remote monitoring, it converts 98 litres of urine to 1kg fertiliser (struvite).

References & Further Reading

can be found on page 255



Figure 7: Components of the Diamond Reactor

Innovations for the Wider Caribbean Region from South-East Asia, the Zyclone Cube by SCG Chemicals, Thailand

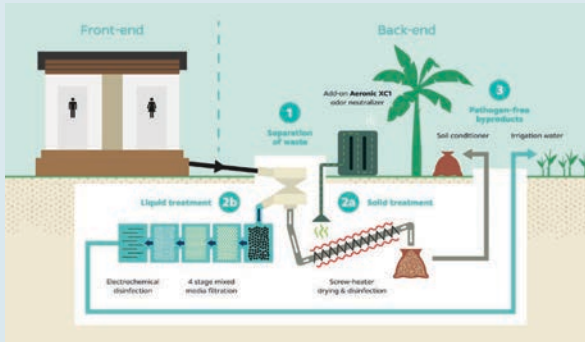

Figure 1: Zyclone Cube

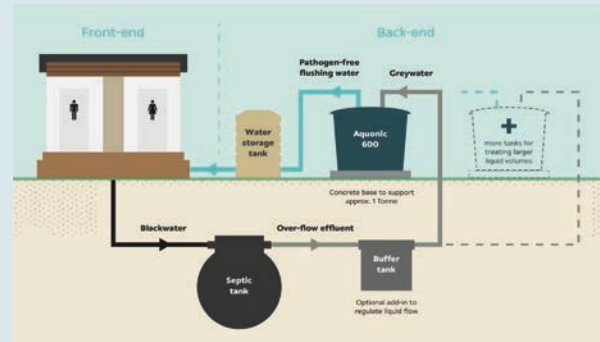

Figure 2: Liquid processing after septic tank

Integrating with a conventional flush toilet, the Zyclone Cube is designed for efficiently separating and effectively treating both solid and liquid fractions. The Zyclone shape (Figure 1, 1) achieves liquid separation at greater than 98 %. The solids fraction is dropped into a screw heating device (2a) that operates intermittently in dehumidifying and inactivating pathogenic contents. The liquid is further treated by integrated absorptive media (e.g. modified soil and zeolite) in a series of anaerobic, aerobic and anoxic chambers prior to a final step of electrochemical disinfection (2b).

Considerations: The separated liquid is first filtered in a plastic media chamber (Figure 3, 1) to remove coarse solid particles. The next two chambers (2 and 3) are filled with synthesised media at 2 cm and 1 cm diameter, respectively. In the anaerobic chamber (2), the organic loading is reduced prior to an aerobic chamber (3) equipped with microbubble aeration that further removes COD, TN and TP contents.

In the next chamber (4), TN is greatly reduced by zeolite media in an anoxic condition. Chamber (5) is designed to recirculate the treated liquid to the anaerobic chamber (2) in order to increase the overall treatment performance. The final chamber (6) is equipped with electrochemical electrodes that inactivate the pathogens remained in the liquid prior to discharge. The separated fresh faecal matter (solid) is collected in a chamber located below the Zyclone separator and can be disinfected and the moisture content reduced by a screw heating device. The heating device could inactivate helminths 4-5 log values and E. coli by 6 log value.

The liquid treatment unit, producing pathogen-free water, can process greywater or effluent from septic tanks suitable for reuse as flushing or irrigation water (Figure 2).

References & Further Reading

can be found on page 257

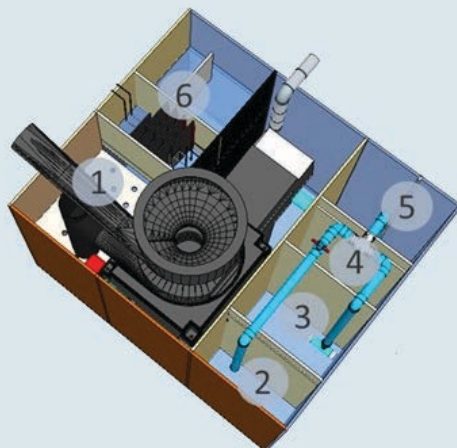

Figure 3: Liquid processing components

- 1 Up-flow filter
- 2 Anaerobic chamber
- 3 Aerobic chamber
- 4 Anoxic chamber
- 5 Recirculation unit
- 6 Electrochemical disinfection

Part 3 Cross-Cutting Issues for Planning and Decision Making – Beyond Systems and Technologies

As introduced in the Terminology section of this Compendium, a Sanitation System can be logically designed by selecting a Technology for each Product from each applicable Functional Group. However, the selection and sustainable functionality of the most appropriate combination of sanitation technologies does not obey technical considerations only. They are influenced by surrounding factors, such as the local built and natural environment above and underground; megatrends, such as climate change; and the so-called “enabling environment”, i.e. political leadership, empowered communities, effective regulation, accountability and more.

In this section, the cross-cutting issues mentioned above are not simply enumerated. Rather, the “**Regional Strategic Action Plan for the Water Sector in the Caribbean to Develop Resilience to the Impacts of Climate Change**” (**RSAP**) was chosen as the relevant regional framework for their presentation. There are other regional or sub-regional policies, strategies and action plans that relate to water resource management. Therefore, it should be noted that for this Compendium, the RSAP serves as an example to guide planning and decisionmaking in the sanitation sector.

Substantial efforts have been made by national, international and multilateral partners in developing the RSAP. **The Plan outlines the core structural problems the region’s utilities need to address, and the impacts of climate change on resources and water and sanitation services, while proposing responses to each and establishing a framework for action at national and regional levels.** It was adopted during the 15th High-Level Forum for Caribbean Ministers Responsible for Water with the “Declaration of Basseterre” signed by 16 Ministers in October 2019.

Supported by regularly updated implementation plans, the RSAP represents a coordinated effort for collective action among regional governments, multilateral development banks, international organisations and professional associations, managed by the Caribbean Water and Wastewater Association.

The RSAP is built along **five main pillars**, namely (i) water sector governance, (ii) decision support, (iii) water resources management, (iv) provision of water services and (v) capacity building and public sensitisation. Given the disproportionate impacts of water scarcity and extreme weather events on women in the Caribbean, it is important that all interventions in the water and sanitation sector recognise and cater to the need for gender sensitivity in planning, implementation, monitoring and evaluation. This is particularly the case with respect to interventions that are designed for increasing resilience to the impacts of climate change or for reducing exposure to natural disasters. Stakeholder engagement and creating empowered communities are fundamental to the RSAP.



Figure 1: Historical Hurricane Tracks 1851-2016
(Front cover of the RSAP, 2019)

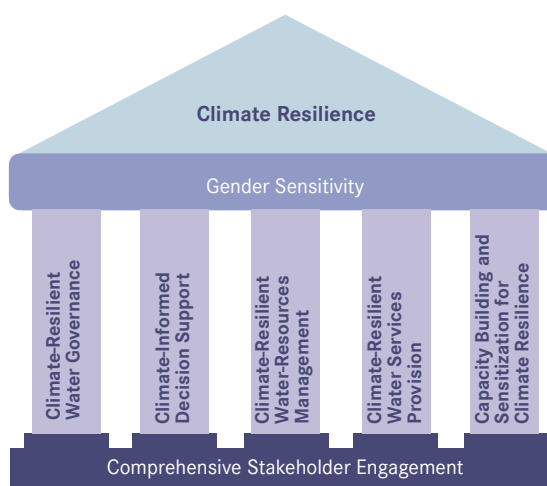

Figure 2: Five Pillars of the Regional Strategic Action Plan

The three strategic building blocks, *stakeholder engagement*, *gender sensitivity* and *climate resilience*, are essential components of the RSAP and are addressed first. Next, the cross-cutting issues highlighted in this section are structured along the five pillars of the RSAP.

X A - Stakeholder Engagement

X B - Gender Sensitivity

X C - Climate Resilience

X C.1 - The International Discourse on Climate Change and Resilience in the Sanitation Sector

X C.2 - Co-Benefits for Better Resilience with Nature-Based Solutions

X 1 - Climate-Resilient Water Governance

X 1.1 - Institutional and Regulatory Environment

X 1.2 - Working with Existing Standards and Guidelines

X 1.2.1 - Protocol concerning Pollution from Land-Based Sources and Activities to the Cartagena Convention (LBS-Protocol)

X 1.2.2 - ISO Standards for Sanitation Systems and Technologies of this Compendium

X 1.2.3 - Guidelines and Certification Process for Sustainable Biochar Production and Biochar Based Carbon Sinks

X 2 - Climate-Resilient Water Resources Management

X 2.1 Integrated Sanitation and Groundwater Assessment

X 2.2 Managed Aquifer Recharge and Aquifer Storage and Recovery

X 2.3 Rainwater Harvesting

X 3 - Climate-Informed Decision Support

X 3.1 A lesson based on institutional developments, standards and river quality in the UK

X 3.2 A lesson based on how East Asian “Tiger States” delivered sanitation within a generation

X 3.3 Linking local monitoring and decision-making with SDG6 progress and reporting

X 4 - Climate-Resilient Water and Sanitation Services Provision

X 4.1 Planning Principles for Sanitation Systems

X 4.2 Costing Principles for Sanitation Systems

X 4.3 Other Key Areas of Environmental Sanitation

X 4.4 Operation & Effective Asset Management

X 4.5 Climate-Sensitive Sanitation Financing

X 5 - Capacity Building and Sensitisation for Climate Resilience

X 5a Research and Development

Another important factor for choosing the RSAP framework with its focus on climate resilience is rather pragmatic: all multilateral development banks must do greenhouse gas (GHG) accounting on their projects. And they have or are developing GHG accounting tools to do that. However, when GHG accounting specialists are examining a sanitation project, they do not necessarily understand where all the leaks (greenhouse gas emissions), the potential co-benefits or all the climate impacts happen and the differences between networked and non-networked solutions, for example. As sanitation professionals, we must educate them about sanitation because we need to concomitantly move this agenda forward – the RSAP’s framework is a welcome opportunity to do this.

X A – Stakeholder Engagement

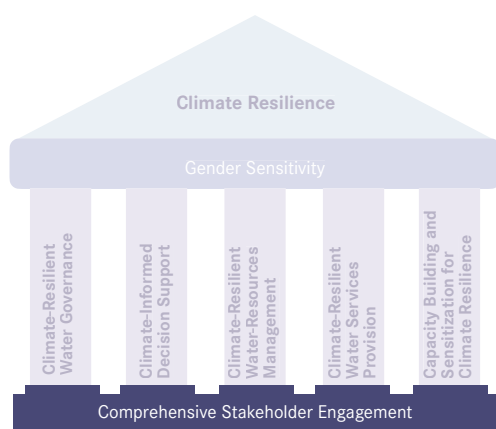

The RSAP... intends to create empowered communities and describes Stakeholder Engagement as being fundamental. Among others, the specific section on Community Engagement states:

It is not possible for any government to manage the national water resources effectively without the engagement and participation of the public, individually and through community-based and other civil society organisations. Therefore, local communities should be enlisted as essential allies in protecting water resources and they should be given meaningful roles in helping to shape the decisions that are

made concerning the management of the resource. Every effort must be made to educate consumers and communities and involve them in managing their water resources. Creative communications and messaging is necessary, encouraging school children and communities to learn and act, including advocating with politicians on this issue (Moss, 2015).

The 2nd Implementation Plan of the RSAP...

*To succeed, the Action Plan will **require stakeholders** at all levels to **deviate from business as usual**. It will be necessary to do different things from what they have been doing and to do many of the things they have been doing differently. This change in culture, attitudes and practice will not happen overnight. It will require constant public education, encouragement and reinforcement. The sellers of the Plan must be credible and relatable and must, whenever possible, be prepared to lead by example.*

The six systems and 48 technologies presented in this Compendium are all but business as usual. In line with the RSAP, the Compendium is a guidance document primarily intended to be used for **communicative planning processes involving local communities and other stakeholders**.

The user has a key role and also responsibility in the service delivery. Without the User embracing this role, sustainable service provision cannot take place. For more information on roles and responsibility, see X 2.1 Effective Regulation and Accountability.

The starting point is a reliable provision of an aspirational service, allowing the User to really enjoy the benefit of the services. This is the prerequisite for assuming all other roles and responsibilities, such as respecting the terms & conditions, paying tariffs

and/or taxes, respecting other users, respecting the service provider and engaging in public interest issues - joining stakeholder meetings, consultation meetings on new infrastructure upgrades or joining the debate on adequate tariff structure. This implies that the household is at the centre of each decision-making process, e.g. on the selection of the most suitable sanitation system from the User Interface down to the final disposal or reuse of the treated effluent.

The case study on the Municipality of Tolata (Bolivia) demonstrated that active community participation solved a problem that the Municipality could not solve alone: identifying the required piece of land for the wastewater treatment plant. It was offered by farmers close to the facility - in exchange for access to the treated effluent.

Agreed - this is an ideal scenario. However, it underpins the powerful role community participation plays. Sometimes, it is noted through lucky coincidences mentioned above, more often it is noticed when projects “fail” in one way or another, before or - worse - after construction of the hardware.

By involving all relevant stakeholders, particularly the targeted community, community engagement aims to consider the entirety of perspectives and expectations, thereby helping to find and implement the best possible environmental sanitation solution. Real engagement with the community during planning and implementation can ensure better project ownership and foster trust and social capital in a neighbourhood. Many methodologies and approaches have been developed in the past

decades to facilitate successful service provision and a reliable long-term relationship with the community. Examples include SARAR or PHAST and Community-Led Urban Environmental Sanitation (CLUES).

An important part of community engagement that planning and decision making cannot afford to ignore is the aspect of valuing local expertise, indigenous knowledge and water wisdom. *“Across the world, indigenous peoples already manage many water-related risks in a changing climate with traditional knowledge and solutions. In many cases, these measures align with the actions deemed necessary on a global scale by water and climate experts. This relationship deserves greater attention and consideration within national and global climate action arenas.”* (SIWI, 2021)

BOX: Local Expertise, Indigenous Knowledge and Wisdom

There is no lack of international awareness - a lot of catching up has been achieved on the level of the UN over the last 20 years, such as the adoption of the Declaration on Rights of Indigenous Peoples (2007), the Human Rights to Water and Sanitation (2010 and 2012) and the Resolution on the Human Right to a clean, healthy and sustainable environment adopted by the Human Rights Council in 2021 (HRC/RES/48/13). As stated by the World Water Forum’s input to the High-Level Political Forum’s review process on SDG 6 in 2016:

- Although climate change and global systems have created great health disparities and access to clean water in Indigenous Nations and their communities, solutions are found in traditional knowledge and practice.
- While many conventions, declarations and laws already exist regarding water rights at large, their implementation and enforcement are weak..

References & Further Reading

can be found on page 257

X B – Gender Sensitivity

The RSAP... emphasises that there must also be gender sensitivity in the formulation of interventions and the execution of activities, given the disproportionate manner in which women and children are impacted by water crises (p.4).

Given the disproportionate impacts of water scarcity and extreme weather events on women in the Caribbean, it is very important that all interventions in the water and sanitation sector recognize and cater to the need for gender sensitivity in planning, implementation, monitoring and evaluation. This is particularly the case with respect to intervention that are designed at increasing resilience to the impacts of climate change or reducing exposure to natural disasters (p.27).

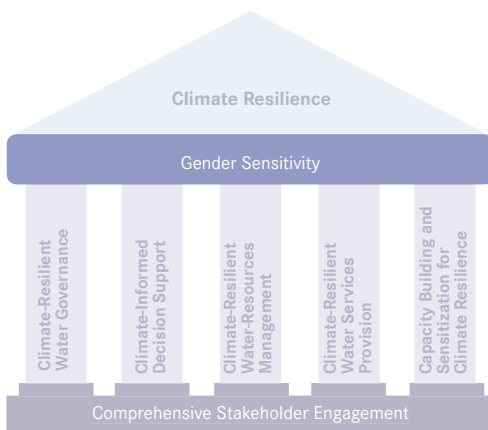

This section with guiding questions is adapted from the Factsheet “Water, Sanitation and Gender” (sswm.info). While current publications may broaden the concept of “gender sensitivity” to “inclusive and equitable (or universal) design”, i.e. creating facilities and offering services that can be used by everyone, irrespective not only of gender, but also of age, disease or disability, the guiding questions are helpful in conveying an attitude and understanding to ensure that everyone’s needs (e.g. of women and girls) are taken into consideration. Mainstreaming inclusive and equitable design in the sector can add to its effectiveness and efficiency. The following guiding questions can assist in the process of integrating a gender perspective in sustainable sanitation planning, design and implementation. Wherever appropriate, the questions may be adapted to be more inclusive (beyond gender).

Gender analysis:

- Have you investigated the gender issues related to sanitation provision and use in the project area?
- Are women’s (and men’s) needs, interests and priorities regarding sanitation clear?
- What are the gender-specific elements in the sanitation policies and strategies of the government, company or institution?
- Did you use a gender perspective to gather information? Are the gathered data sex-disaggregate?

Institutional aspects:

- Is expertise in social development, sanitation and hygiene education available in the organisation, project or program team?
- Are women and men fully involved in the organisation and have internal discriminatory factors been tackled successfully?
- Are there any constraints to women and/or men in accessing the resources?

Gender impact assessment:

- Will the program objectives and activities have an impact on existing inequalities between women and men, boys and girls?
- How will the program affect women and men? For instance, will their work burdens be in/decreased; their health be affected; economic benefits reached. Is there gender balance in the burdens and benefits?
- Is the budget gender sensitive?
- Gender Specific Monitoring and Evaluation: Do you measure and monitor for separate effects on women, men, girls and boys? How?

Location and design:

- Does the design and location of sanitation facilities reflect the needs of women and men?
- Are toilets situated in such a way that the physical security of women and girls is guaranteed?
- Is the location close to home and is the path accessible and well lit?
Are separate toilets for women and men, boys and girls constructed and maintained (e.g. in schools, factories and public places)?

Technology and resources:

- Does the technology used reflect women's and men's priorities and needs?
- Is the technical and financial planning for ongoing operation and maintenance of the facilities in place?
- And how are women involved?
Have funds been earmarked for separate sanitation facilities for girls and boys, and for hygiene education in school curricula? (See also school campaigns)

Empowerment and decision-making:

- Is the capacity of women being developed and their participation in trainings being encouraged?
- Are women and girls enabled to acquire access to relevant information, training and resources?
- Is there gender balance in decision-making?
- Are women involved in the planning (incl. location and quality) and management of sanitation services? Have hygiene education messages been promoted through women's groups, schools and health clinics?

References & Further Reading

can be found on page 258

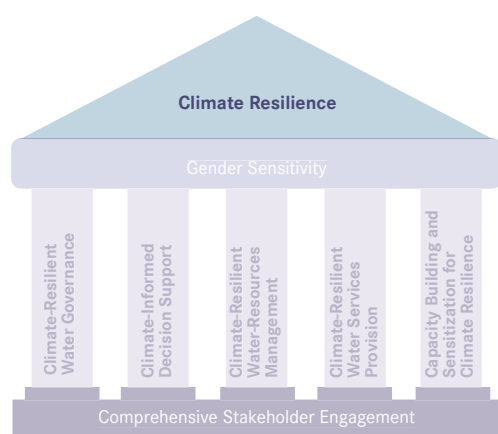

The Intergovernmental Panel on Climate Change (IPCC)... defines the term resilience as “the capacity of social, economic and ecosystems to cope with a hazardous event or trend or disturbance, responding or reorganising in ways that maintain their essential function, identity and structure as well as biodiversity in case of ecosystems while also maintaining the capacity for adaptation, learning and transformation. Resilience is a positive attribute when it maintains such a capacity for adaptation, learning and/or transformation” (IPCC 2022, p.35)

The RSAP... provides a succinct background of the main framework conditions, influencing factors and challenges for the water and sanitation sector in the Caribbean (Introduction + The Current Situation, pp. 6-26). The description of relevant climate change impacts, as well as the main risks and costs of inaction form the basis for collective action towards climate resilience.

X C.1 The International Discourse of Climate Change and Resilience in the Sanitation Sector

The RSAP is backed by the five major agreements adopted by UN member states in or shortly after 2015 to define the future global development framework until 2030: the Paris Agreement, the Sendai Framework for Disaster Risk Reduction, the Sustainable Development Goals, The Addis Ababa Action Agenda and the New Urban Agenda. This chapter provides a brief introduction to four of the five agreements and the study on Climate Resilient Urban Sanitation – all relevant to implementing the RSAP in the sanitation sector.

The Sustainable Development Goals (SDGs) were adopted in September 2015 by 193 countries of the UN General Assembly as part of the Resolution “Transforming our World: The 2030 Agenda for Sustainable Development”. The SDGs specify the goals and targets to be achieved by 2030 that are part of the Agenda. Three of the SDGs are most relevant to Climate Resilient Urban Sanitation:

- SDG06:** Ensure availability and sustainable management of water and sanitation for all
- SDG11:** Make cities and human settlements inclusive, safe, resilient and sustainable
- SDG13:** Take urgent action to combat climate change and its impacts.

The Paris Agreement was adopted in December 2015 by 195 UN Member countries in Paris, France, as a legally binding international treaty on climate change. Its goal is to limit global warming to well below 2, preferably to 1.5 degrees Celsius, compared to pre-industrial levels. This will be achieved through a series of global, regional and country-level efforts. The Paris Agreement works on a 5-year cycle of increasingly ambitious climate action. Each nation is required to develop their successive Nationally Determined Contributions (NDCs). Through their NDCs, countries primarily outline and communicate actions they plan to take to reduce GHG emissions to reach the goals of the Paris Agreement. Planned adaptation and resilience building measures at the country-level are also communicated in the NDCs. Although the NDCs are non-binding, they provide an indication of national policy priorities and interests. A recent analysis showed that within all submitted NDCs only a few concrete actions have been proposed with regard to sanitation.

The Paris Agreement re-emphasises the role of National Adaptation Plans (NAPs) which were established under the Cancun Adaptation framework. NAPs were created to enable least developed and other developing countries to identify medium- and long-term adaptation needs and develop



Figure 1: Key Global Agreements post-2015 (illustration from UN-Habitat, 2020, p. 136)

implementing strategies and programmes to address them. The NAP process would build on existing activities, providing a platform for coordination of adaptation efforts at the national level. For example, **Saint Lucia developed a water sector NAP** (Sectoral Adaptation Plan for Water), which includes proposed wastewater and faecal sludge interventions to be accomplished through the development of a wastewater master plan and guidelines. Thus far, only 22 developing countries have submitted NAPs.

The Sendai Framework for Disaster Risk Reduction (2015–2030) was adopted in March 2015 as an outcome of the Third United Nations World Conference on Disaster Risk Reduction in Sendai, Japan. The framework identifies four priority areas for action, namely:

- Priority 1:** Understanding disaster risk.
- Priority 2:** Strengthening disaster risk governance to manage disaster risk.
- Priority 3:** Investing in disaster risk reduction for **resilience**.
- Priority 4:** Enhancing disaster **preparedness** for effective response and to “Build Back Better” in recovery, rehabilitation and reconstruction.

Because of the importance of “Resilience” for planning, decision-making and implementing sanitation systems in the Wider Caribbean Region, the corresponding terminology and concepts are elaborated further in the following section. The content is adapted from the “Compendium of Sanitation Technologies in Emergencies”, introduced earlier in this Compendium (p. 10).

Preventive measures can help to reduce the severity of a disaster and to streamline disaster management. Many emergency situations follow predictable patterns and most disaster-prone regions are well known. At the same time, disaster and crisis scenarios are becoming increasingly complex and traditional re-active relief interventions are proving insufficient. Disaster prevention or mitigation, thus, has an important role to play and must be considered by both relief and development actors to address the underlying vulnerabilities and to build capacities to cope better with future shocks. Preventive measures include strengthening resilience, increasing preparedness in case of an acute emergency and disaster risk reduction (see Table 1). These are integral parts of both sanitation planning and national, regional and local development strategies.

Resilience

At its core, resilience can be described as the ability of countries, communities, individuals, or organisations that are exposed to disasters, crises and underlying vulnerabilities to manage change. This can be achieved by anticipating, reducing the impact of, coping with and recovering from effects of adversity without compromising long-term prospects. Strengthening resilience requires longer-term engagement and investments. It needs an in-depth analysis of previous emergencies, of underlying causes of vulnerability and of existing human, psychological, social, financial, physical, natural or political assets at different levels of society. The goal is to develop locally appropriate measures that can be incorporated into existing structures and processes to increase the capacity and capabilities of the involved stakeholders and their self-organisation potential. Important components to enhance resilience include capacity development, training, education, awareness raising, sensitisation and advocacy, as well as improving the robustness and durability of implemented sanitation technologies and services.

Robustness is the ability of a technology to provide a satisfactory outcome in a variable environment. It is important that in emergencies, sanitation technologies be resilient against failure and keep functioning despite disruptions (such as power cuts, water shortages and floods). It is, therefore, important to think about robustness early in the planning for sanitation provision. Given the uncertainties, it is advisable to consider sanitation systems so that they are functional in a range of possible scenarios. For example, flood-proof, raised latrines can hinder sludge from overflowing during floods and wastewater; wastewater treatment plants could have stormwater by-passes. There is no 'silver bullet' for planning a robust sanitation option. Each technology has specific strengths and weaknesses depending on the local context and available skills and capacity.

Durability is the ability of a technology to last a long time without significant deterioration. The longer it lasts, the fewer resources are needed to build replacements and the more resistant technologies are to wear and tear,

thus, further reducing the operation and maintenance (O&M) costs along with the risks of failure. Technologies should be chosen by taking into account the local capacities for O&M, repair and the availability of spare parts. It may be necessary in some cases to choose a lower level of service to avoid having equipment that cannot be easily repaired (e.g. pumps, grinders, etc.). To increase the durability of most treatment technologies, appropriate pre-treatment needs to be considered.

Preparedness

The Sphere guidelines (applied in Humanitarian Assistance) describe the term preparedness as precautionary measures taken in view of anticipated disaster or crisis scenarios to strengthen the ability of the affected population and involved organisations to respond immediately. Preparedness is the result of the capacities, relationships and knowledge developed by governments, humanitarian agencies, local civil society organisations, communities and individuals to anticipate and respond effectively to the impact of likely, imminent hazards. People at risk and the responsible organisations and institutions should be able to make all necessary logistical and organisational preparations prior to a potential event and know what to do in case of an emergency. Apart from early warning systems and the development of emergency plans, this can include the stockpiling of equipment, as well as the availability of potential evacuation plans.

Disaster Risk Reduction and Prevention

Disaster Risk Reduction (DRR) can be seen as an umbrella term for all preventive measures, including those described under resilience and preparedness. It aims to reduce disaster risks through systematic efforts to analyse and reduce the causal factors of disasters. Examples of disaster risk reduction include reduced exposure to hazards, reducing the vulnerability of people and property, proper management of land and the environment and improving preparedness and early warning systems. A proper risk analysis forms the basis for adequate DRR measures. It assesses the potential exposure of communities to these risks, the social and infrastructural vulnerabilities and the capacities of com-

munities to deal with risks. The importance of the DRR approach is being increasingly recognised by the international community. Historically, development actors have not invested significantly in DRR and prevention, whether due to a lack of awareness, a lack of incentives or a lack of emergency-related expertise. In recent years, DRR and conflict prevention have, therefore, turned into cross-cutting issues that are addressed through relief, recovery and development instruments. Non-functioning or inadequate sanitation services can potentially cause disasters, and hazards in turn can degrade sanitation services, resulting in increased disaster risk. It is, therefore, necessary to consider potential disaster risks when setting up or developing sanitation services

Tab. 1: Preventive Measures, Definitions and Implications for Sanitation Infrastructure (Gensch et al., 2018)

	Definition	Key Aspects Related to Sanitation Infrastructure
Resilience	Ability of countries, communities, individuals, or organisations to manage change when exposed to disasters, crises and underlying vulnerabilities.	<ul style="list-style-type: none"> • Implementation of robust and durable sanitation infrastructure adapted to local extreme conditions • Capacity building on how to build, repair, operate and maintain sanitation infrastructure • Hygiene promotion and sensitisation measures • Establishing community structures (WASH committees & health clubs)
Preparedness	Precautionary measures to strengthen the ability of the affected population and involved organisations to respond immediately.	<ul style="list-style-type: none"> • Contingency planning and emergency preparedness plans, including how to deal with wastewater when sewer networks do not function, and how to deal with faecal contamination of water sources • Stockpiling of sanitation equipment and availability of materials/infrastructure • Emergency services and stand-by arrangements • Establishment of support networks among different regions • Capacity building and training of volunteers and emergency personnel • Strengthening of local structures through community planning and training
Disaster Risk Reduction	All preventive measures (incl. resilience and preparedness) that aim to reduce disaster risks through systematic efforts to analyse and reduce the causal factors of disasters.	<ul style="list-style-type: none"> • Reducing the potential impact of hazardous events on sanitation hardware and services (resilience and mitigation) • Ensuring a rapid service level and structural recovery of sanitation hardware and services after hazardous events (preparedness) • Ensuring that the sanitation system design addresses earlier vulnerabilities (build back better and resilience) • Ensuring that sanitation services have minimal negative effects on society (do no harm)

The New Urban Agenda (NUA) is the agreement adopted at the United Nations Conference on Housing and Sustainable Urban Development (Habitat III) in Quito, Ecuador, in October 2016. The NUA was the primary goal and outcome of Habitat III and was endorsed by the UN General Assembly later that year. The NUA gives clear guidance on how well-planned and well-managed urbanisation can be a transformative force to accelerate towards the Sustainable Development Goals.

With regard to IWRM (integrated water resources management), the NUA commits “to promote conservation and sustainable use of water by rehabilitating water resources within the urban, periurban and rural areas, **reducing and treating wastewater**, minimizing water losses, **promoting water reuse** and increasing water storage, **retention, and recharge**, taking into consideration the water cycle” (NUA 73).

On the water and sanitation front, the NUA underscores the importance of “**protective, accessible and sustainable infrastructure and service provision systems for water, sanitation and hygiene, sewage, solid waste management**, urban drainage, reduction of air pollution and stormwater management, in order to improve safety in the event of water-related disasters, improve health, (...) access to **adequate and equitable sanitation and hygiene** for all and end open defecation, with special attention to the needs and safety of women and girls and those in vulnerable situations” (NUA 119). In managing the water and sanitation sector, the NUA commits to **building the capacity of public water and sanitation utilities to be able to implement sustainable water management systems (including sustainable maintenance of urban infrastructure services)** with the goal of eliminating inequalities and “promoting both universal and equitable access to safe and affordable drinking water for all and adequate and equitable sanitation and hygiene for all” (NUA 120).

The NUA also commits to **integrating climate change adaptation and mitigation** considerations “into age- and gender-responsive urban and territorial development and planning processes including greenhouse gas emissions, **resilience-based and climate-effective design of spaces, buildings and constructions, services and infrastructure and nature-based solutions**; promote cooperation and **coordination across sectors**, as well as **build capacity of local authorities** to develop and implement disaster risk reduction and response plans, such as risk assessments on the location of current and future public facilities” (NUA 101). Further, the NUA commits to **supporting access to funding sources for climate change mitigation and adaptation** “including the Green Climate Fund, the Global Environment Facility, the Adaptation Fund and the Climate Investment Funds, among others” (NUA 143).



The Climate Resilient Urban Sanitation Study has emerged from the need to address sanitation more prominently and to ensure that, it does not “fall between the cracks”, as quoted below. On the contrary, the study argues that sanitation can be a crucial driver for climate change adaptation and mitigation, safeguarding public health through investments in resilient sanitation systems, thereby creating a sustainable economy around sanitation services, as well as fostering innovation as a pivotal component of combating climate change at the global scale.

“The beauty of sanitation is that it touches on all aspects of development – health, wellbeing, dignity, environment, agriculture, climate and more. But it’s also the curse of sanitation, that it touches on all these aspects. And sometimes it falls between the cracks or gets captured

by one of these aspects” (Martin Gambrill, World Bank, Lead “City Wide Inclusive Sanitation” Global Initiative, 23.6.2021, launch of the publication “Climate Resilient Urban Sanitation”, <https://youtu.be/67p7bTx3Ozw>)

Strengthening many arguments of the RSAP, the study is helpful for practitioners interested in getting deeper insight in the debate around climate resilient urban sanitation and may serve as a resource for developing concept notes and proposals in that regard. This chapter concludes with the following quotes from the study reflecting on the “International Discourse on Climate Change and Resilience in the Sanitation Sector”:

- There is no blueprint for achieving climate resilience for urban sanitation systems. Climate change manifests itself differently around the globe and even within individual cities. Cities start from different levels of preparedness and capacities when facing these challenges. It is not just sanitation infrastructure that must be resilient to everchanging shocks and stresses, but also the interconnected social, institutional and physical systems. As the adage goes, ‘**resilience is not an end state; it’s a journey**’.

- The City Water Resilience Framework (Arup 2019) suggests that resilient systems have seven main qualities which allow to maintain functionality in the face of climate-related shocks and stresses: reflective, robust, redundant, flexible, resourceful, inclusive and integrated.

References & Further Reading

can be found on page 258

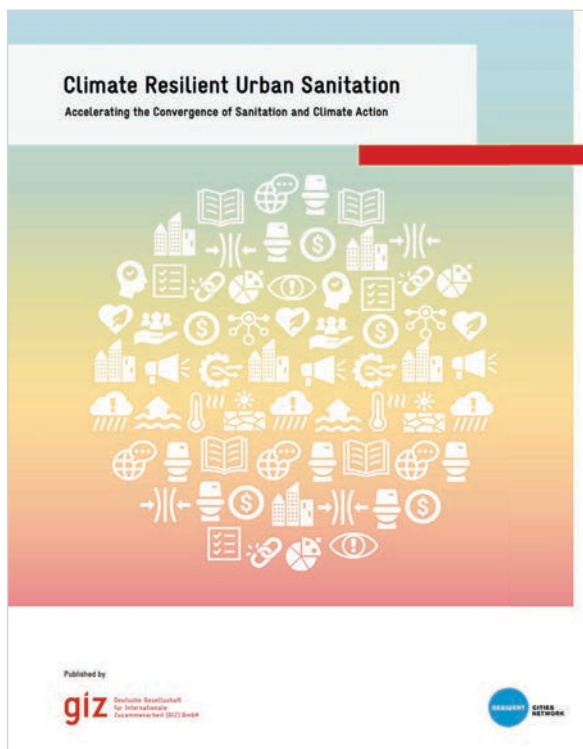

XC.2 Co-benefits For Better Resilience with Nature-Based Solutions (NBS)

It can be difficult for wastewater utility managers to understand under what conditions such nature-based solutions (NBS) might be applicable and how best to combine traditional infrastructure, for example, an activated sludge treatment plant, with an NBS, such as treatment wetlands. This section is adapted from the IWA publication “NBS for Wastewater Treatment” (Cross et al., 2021, 340p.), presented on page 11 of this Compendium. Technical references, case studies and guidance enable stakeholders to understand the design parameters, removal efficiencies, costs, co-benefits for both people and nature as well as trade-offs for consideration in their local context. Authors in this section are cited as in Cross et al., 2021.

NBS as defined by the International Union for the Conservation of Nature are “actions to protect, sustainably manage and restore natural or modified ecosystems that address societal challenges effectively and adaptively, simultaneously providing human well-being and biodiversity benefits” (Cohen-Shacham et al., 2016). NBS can be used to treat different wastewater types, including municipal, agricultural and industrial wastewater, leachates and stormwater. The application of NBS in wastewater treatment aims at developing engineered systems that mimic and take advantage of functioning ecosystems with minimal dependence on mechanical elements. NBS use plants, soil, porous media, bacteria and other natural elements and processes to remove pollutants in wastewater, including suspended solids, organics, nitrogen, phosphorus and

Tab. 1: Co-benefits for better resilience with nature-based solutions for wastewater treatment (from Cross et al., 2021)

Co-Benefit	Definition	Source
Biodiversity (fauna)	Variability among living organisms from all sources, including, inter alia, terrestrial, marine and other aquatic ecosystems and the ecological complexes of which they are part; this includes diversity within species, between species and of ecosystems. All animals (kingdom Animalia), Fungi (Fungi) and any of the various groups of bacteria.	
Biodiversity (flora)	Variability among living organisms from all sources, including, inter alia, terrestrial, marine and other aquatic ecosystems and the ecological complexes of which they are part; this includes diversity within species, between species and of ecosystems. Any organism in the kingdom Plantae.	
Pollination	Animal pollination is an ecosystem service mainly provided by insects, but also by some birds and bats. Pollination is essential for the development of fruits, vegetables and seeds.	TEEB (2010)
Carbon sequestration	The process of removing carbon from the atmosphere and depositing it in a reservoir or carbon sinks (such as oceans, forests or soils) through physical or biological processes, such as photosynthesis.	UNFCCC (2021)
Temperature regulation	The regulation of humidity and localised temperatures during hot weather conditions, including through ventilation and transpiration.	Haines-Young and Potschin (2018); Baker et al., (2021)
Flood mitigation	The regulation of water flows by virtue of the chemical and physical properties or characteristics of ecosystems that assists people in managing and using hydrological systems, and mitigates or prevents potential damage to human use, health or safety (e.g., mitigation of damage as a result of reductions in magnitude and frequency of flood/storm events).	Haines-Young and Potschin (2018)

pathogens (Kadlec and Wallace, 2009). NBS also have the capacity to remove emerging contaminants, such as steroid hormones and biocides (Chen et al., 2019), personal care products (Ilyas et al., 2020) or pesticides (Vymazal and Březinová, 2015). Different types of NBS can be combined to achieve the desired treatment efficiency.

Using NBS for wastewater treatment can contribute towards healthier environments by improving water quality and enhancing the natural environment and surrounding habitats. Natural areas and NBS can enhance and promote physical and mental health, clean air and clean water. Furthermore, NBS can provide aesthetic appeal and restorative properties, drawing people together and strengthening community ties. Economic benefits include lower water treatment costs, reduced flood damage costs, healthier fisheries, better recreational opportunities and increased tourism and economic development. To account for such benefits, a holistic cost-benefit analysis is required (Elzein et al., 2016; WWAP, 2018).

NBS are multifunctional, providing many benefits to the environment and society (Droste et al., 2017). A valuable overview, specifying 13 co-benefits when NBS are used for wastewater treatment, have been compiled by Cross et al. (2021, p.10-12), of which six are presented in Table 1.

This information can contribute towards cost-benefit analyses of NBS, which account for benefits beyond water quality treatment, and can be an essential step in achieving efficient investments and support across multiple sectors (WWAP, 2018).

Reduced Cost to the Operator and the Environment with NBS

Because of less (or none) electro-mechanical machinery and input of chemical reagents, NBS and other gravity-fed treatment systems can be designed to have lower carbon footprints and also lower operation and maintenance costs compared to conventional activated sludge systems.

References & Further Reading

can be found on page 258

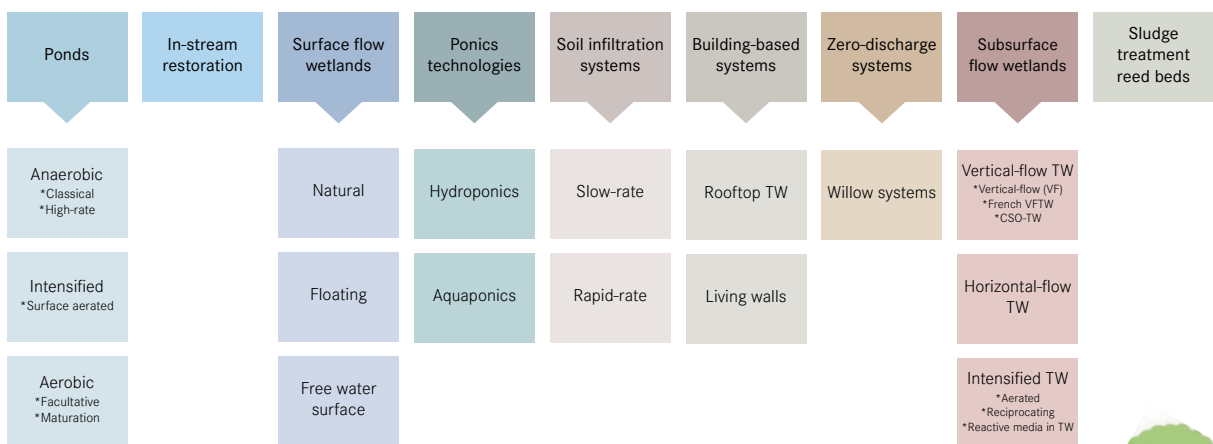

Figure 1: Classification of water-based and substrate based NBS for wastewater treatment (from Cross et al., 2021) NBS in this Compendium are 19 technologies: T.5-T.10, T.15-T.17, R.1-R.9 and R.12 (green NBS-label)



X 1 Climate Resilient Water Governance

The RSAP clearly spells out the issue of governance as “perhaps the most critical ingredient for the successful implementation of the Water Action Plan” in terms of “inter-agency and inter-sector coordination and collaboration”. Deficiencies are observed both at the level of national policy and overall governance (Castalia, 2017).

National policy:

- Multiple ministries are generally involved in making policies for the water and sanitation sector, without obvious coordination or cohesion.
- In several countries, the regulatory authority does not have full regulatory responsibilities over the water and sanitation sector. The Ministry with responsibility for water is often the agency where the final decision-making authority resides.
- All countries have a Ministry of finance that allocates funding to the public water utility. Nevertheless, some countries also grant responsibility for approving finances to other ministries.

Governance arrangements:

- Responsibilities and procedures are not well defined.
- There is a lack of transparency and consumer involvement.
- Managerial autonomy is limited in some water utilities.
- Financial planning does not consider the costs of expanding and improving services.
- Limited competence, resources and credibility for effective utility supervision.
- Long-term financial plans are seldom included in sector policies.

As a response, RSAP has established a set of objectives around which national-level actions are identified. While national governments and water utilities are largely responsible for these actions, the Implementation Plan recognises the crosscutting and regional common dimensions for which collective or collaborative action can promote best practices and reduce time, effort and costs.

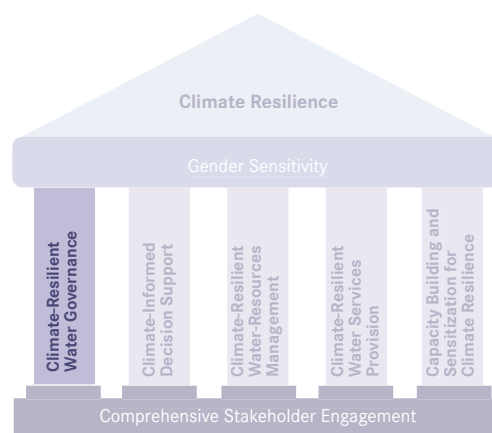

BOX: The relevance of leadership and governance for implementing the RSAP

In a blog, Evan Cayetano, water and sanitation specialist with the IDB, commented:

The 15th High-Level Forum followed a Regional Workshop held February 2020 in Montego Bay, Jamaica, which convened heads of water utilities from across the Caribbean Basin to provide feedback on the RSAP and share insights on how to put the RSAP into action. The Regional Workshop also served to identify areas of intervention that could be supported by the IDB, the Caribbean Development Bank and other development partners. Funding is recognized as a major constraint in extending the reach of water supply and sanitation infrastructure and fortifying these assets to bolster climate change resilience, and with strong governance, this challenge is surmountable by engaging the private sector under public-private partnerships and accessing concessionary loans and grants.

More significant than the financial resources required to support the sustainable and climate-resilient development of the water sector in the Caribbean is the vision, leadership and commitment necessary to follow through on the actions outlined in the RSAP First Implementation Plan. Policymakers must delicately balance their responsibility to provide the human right to water for their constituents while allowing managerial autonomy to water utilities to allocate resources and conduct operations.

X 1.1 Institutional and Regulatory Environment

At this point, it seems appropriate to illustrate the basic principles of how sanitation service delivery works in a given society and its national context, i.e. the interplay and relationships of political power, decision-making, administration and executive power, including enforcement and accountability. Understanding the roles and responsibilities of different actors involved in service delivery is a prerequisite for planners and all stakeholder alike in order to manage expectations, identify overlaps or gaps and address them.

The Compendium is structured along the sanitation service chain, following the flow of the Products via five Functional Groups from the User Interface (U) until the final Reuse and/or Disposal (R).

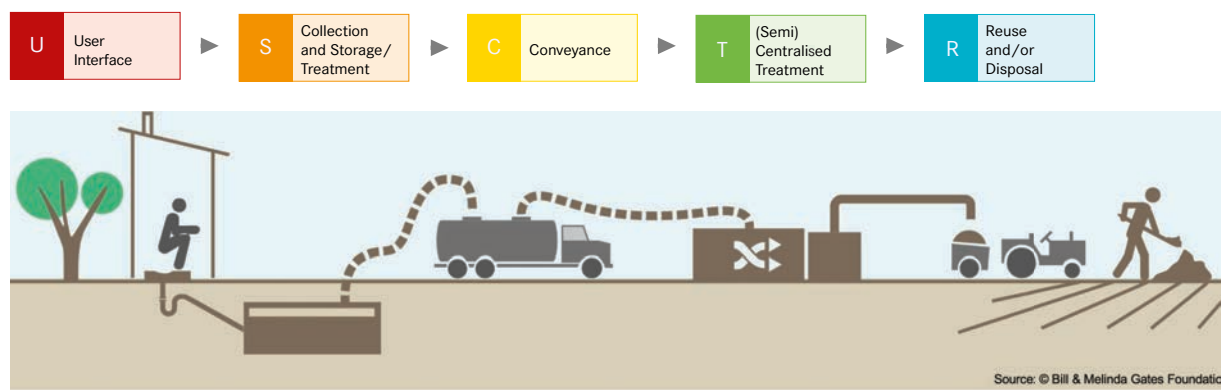

Figure 1: Sanitation Service Chain along the five Functional Groups

However, when it comes to the realisation of the human right to sanitation between the duty bearer and the right holder, it is essential to understand the institutional and regulatory environment, including the corresponding terminology. These relations are illustrated in terms of a socio-political value chain with four links, as suggested by Payen, AquaFed (Bos, 2016), adapted by Reuter (Reuter, 2019).

1. The Policy Maker bearing the duty of implementing the human right to sanitation
2. The Administrator
3. The Operator
4. The User, holding the human right to sanitation

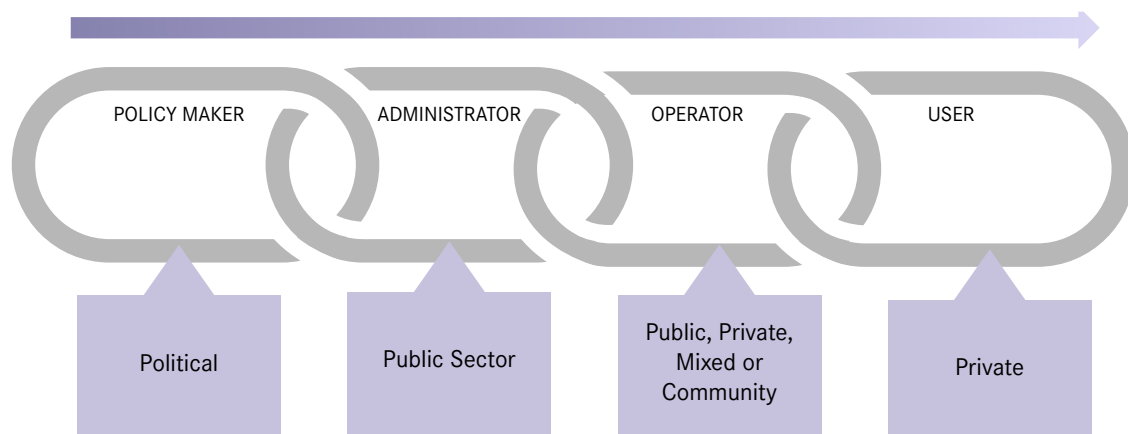

Figure 2: Roles and responsibilities of Political, public and private stakeholders along the socio-political value chain

For the chain to work, each link must be distinct, strong, connected to the others and pulled in the same direction.

Understanding the different roles and responsibilities of each actor in this chain is essential for understanding the institutional and regulatory environment.

The Policy Maker, elected by the User, mandated with political power to represent the state and, therefore, bearing (among others) the duty of implementing the Human Right to Sanitation:

- Decides public policy objectives
- Sets policy for action
- Allocates public resources
- Sets tariffs & cost recovery
- Arbitrates between diverging interests
- Reviews Changes in conditions
- Adjusts Policy Objectives

The Administrator:

- Provides support to the Policy Makers with planning, information, options, etc.
- Is tasked to implement public policy through public procurement and enforcement / compliance
- Is tasked to regulate the services in terms of financial/accounting, technical and quality aspects
- Provides monitoring of the services, including performance control and data collection

The Operator represents the entire “service industry”, i.e. utilities, manufacturers, contractors, consultants, suppliers, professional associations, etc., assuming some or all of the following roles and responsibilities:

- Routine operation
- Customer & community relations
- Maintenance of infrastructure & equipment
- Repair/replace assets
- Construct infrastructure
- Operate cost recovery
- Management of suppliers & sub-contractors
- Provide advice to Policy Makers

The User:

- Enjoys the BENEFIT of the SERVICES
- Respects the terms & conditions
- Pays the Tariff and/or Taxes
- Respects other users
- Respects the service provider
- Engages in public interest issues
- ...and votes for the Policy Maker!

The Policy Maker represents and assumes political power; the Administrator represents public authority; the Operator represents the industry of sanitation services, consisting of for-profit and non-profit public, private or mixed nature entities down to community-based service providers; and the User stands for the person(s) using the sanitation service, generally as a private citizen.

Cities are the predominant places where service delivery is happening and organised. It is, therefore, important to note that this socio-political value chain can apply to the links on the local, regional and national level, e.g. from the Municipal Mayor to the user, the head of the regional or even national government with the respective entities and industries down to the human right holding user, depending on the legal landscape in the respective country.

As mentioned in the RSAP, the roles and responsibilities for regulating and providing sanitation services are often fragmented among various ministries and authorities. The drivers of WASH policies in urban informal settlements include donor and government prioritisation along with local collective action; however, social exclusion, sector fragmentation, residents’ uncertain tenure status and insufficient data for decision-making all impede effective policies (Narayan et al., 2021).

References & Further Reading

can be found on page 259

X 1.2 Working with Existing Standards and Guidelines

This chapter is about standards as referred to in activity 1.1.5 of the RSAP: “Establish an independent national water utility regulator in each Member State, with a mandate to establish and monitor standards and benchmarks, protect consumer interests and set tariffs based on good economic practice and reflective of social and environmental sustainability considerations”. The introduction of new sanitation systems implies new products, new business models and service offerings that require consensus at all levels on what is considered “state of the art”, i.e. the definition of thresholds between acceptable and unacceptable quality – the new “standard” helps manage expectations and build trust among stakeholders.

There are minimum standards for the discharge of treated wastewater into water bodies, which are regulated by national authorities, sometimes by ratification of international protocols. There are also

standards for the quality of a product or a service, which may be defined on a voluntary basis by interested stakeholders, according to an agreed and accepted approach. Both legal and voluntary standards are essential to build trust among stakeholders by ensuring quality for safe products, processes and services – a prerequisite to creating investment security.

This chapter looks at three relevant standards and guidelines:

1. The LBS Protocol to the Cartagena Convention, regulating discharge standards for domestic wastewater
2. ISO standards regulating products and processes of non-sewered sanitation
3. A guideline and certification process for sustainable biochar production

X 1.2.1 Protocol concerning Pollution from Land-Based Sources and Activities to the Cartagena Convention (LBS-Protocol)

The most important regional legal framework regarding marine environmental pollution is the Cartagena Convention and its three Protocols. The Convention entered into force in 1986 and is a legally binding, regional multilateral environmental agreement (MEA) for protecting and developing the WCR (www.unep.org/cep/who-we-are/cartagena-convention). To date, 26 countries have ratified or acceded to the Convention.

The Protocol Concerning Pollution from Land-Based Sources and Activities (LBS Protocol) to the Cartagena Convention was adopted in Oranjestad, Aruba, on 6 October 1999 and entered into force on August 13, 2010.

The Protocol is the most significant agreement of its kind. It has been ratified by 15 countries, making its standards legally binding. It includes regional effluent limitations for “domestic wastewater” (Annex III) and requires the development of plans to address agricultural non-point sources of pollution. Specific schedules for implementation are also included in the

Protocol. The LBS Protocol allows countries to develop and adopt future annexes to address other priority sources of land-based pollution.

In Annex III, “Domestic wastewater” means all discharges from households, commercial facilities, hotels, septage and any other entity whose discharge includes the following: (a) toilet flushing (black water); (b) discharges from showers, wash basins, kitchens and laundries (grey water); or (c) discharges from small industries, provided their composition and quantity are compatible with treatment in a domestic wastewater system. Based on their vulnerability, receiving water bodies are divided into two classes (see Table 1).

References & Further Reading

can be found on page 259

Tab. 1: Effluent limits for domestic wastewater according to Annex III of the LBS Protocol

Parameter	Effluent Limit Class I Waters	Class II Waters
Total Suspended Solids	30 mg/L*	150 mg/L*
Biochemical Oxygen Demand (BOD ₅)	30 mg/L*	150 mg/L*
pH	5-10 pH units	5-10 pH units
Fats, Oil and Grease	15mg/L	50 mg/L
Faecal Coliform (Parties may meet effluent limitations either for faecal coliform or for E. coli (freshwater) and enterococci (saline water))	Faecal Coliform: 200mpn/100 ml; or a. E. coli: 126 organisms/100 ml; or b. enterococci: 35 organisms/100 ml	n/a
Floatables	not visible	not visible

* does not include algae from treatment ponds

There are no effluent limitations for nutrients in Table 1, although

- globally, the natural nitrogen and phosphorus cycles have been altered significantly (see concept of “planetary boundaries” introduced p. 8) and
- regionally, nitrogen and phosphorus are identified as primary pollutants of concern in Annex I; and in Annex III Contracting Parties are required to: *“take appropriate measures (to the extent practicable) to control or reduce the amount of total nitrogen and phosphorus that is discharged into, or may adversely affect, the Convention area”*.

Although the major source of nutrients is from the excessive use and inappropriate application of fertilisers, the impact of point sources, such as the discharges from wastewater treatment plants (WWTPs), should be regulated (see also: the SOCAR report, State Of the Cartagena Convention Area, 2019).

Accordingly, the Cartagena Convention Secretariat is to “Recommend and facilitate necessary amendments to the LBS Protocol to explicitly cover nutrients and links between the state of the Convention Area coastal waters with upstream sector activities and practices”. This is reflected in the Action Framework for the period 2021-2025 of the “Regional Nutrient Pollution Reduction Strategy and Action Plan for the Wider Caribbean Region” (June 2021), supported by a “Technical Paper on Proposed Criteria for Nutrients Discharges for Domestic Wastewater Effluent” (developed on behalf of the GEF CReW+ Project in June 2021 with suggested effluent limits for Total Nitrogen for larger WWTP are in range between 5 – 10 mg/l).

X 1.2.2 ISO Standards for Sanitation Systems and Technologies of this Compendium

Since the publication of the 2nd edition of the Compendium in 2014, significant progress has been made with the publication of three very relevant ISO standards. The standards themselves are a collection of best practices, which promote product compatibility, identify safety issues and share solutions and know-how. ISO standards are technical documents, representing an international consensus of experts and countries on design, performance level and operation.

Purpose of the Standards ISO standards exist to assist industries to adopt practices that help to straighten out

and standardise their internal procedures. At any scale of industrial business, understanding the advantages of standards and the concept a Quality Management Plan (QMP) can lead to a good number of business advantages, reduction of waste, improved efficiency and lower production costs. ISO standards help in speaking the same language worldwide. They facilitate the dissemination of knowledge and good practices. ISO Standards further innovation and limit duplication of efforts as they define the baseline.

Certification to an ISO standard is a mark of quality and robust procedures regardless of a facility's industry or country of origin. ISO guidelines and requirements force a company to initiate, document and meet several complicated organisational standards. Obtaining an ISO certification may help organisations accomplish output goals by forcing the introduction of independently verified operations, quality and management plans. ISO certified organisations also enjoy an increased sense of legitimacy. Certification means that a qualified independent party has reviewed their programmes and certified compliance. In some fields, certification may not be necessary, but in many professional industries, ISO certification is the norm for all customers and competitors.

With the availability of the **management service standard ISO 24521** (Guidelines for the management of basic on-site domestic wastewater services), stakeholders can agree on improved quality standards, e.g. for the safe management of faecal sludge from septic tanks (see Figure 1). The successful introduction and application of this standard in the Mahalaxmi Municipality, Lalitpur, Nepal, was documented by the Faecal Sludge Management Association under: <https://youtu.be/mSKRbj2946Y> (Min 24:22 ff.).

ISO 30500 is a product standard published in October 2018 for non-sewered sanitation systems (NSSS), that provides general safety and performance requirements for product design, performance testing, as well as sustainability considerations of prefabricated integrated treatment units that are not attached to a network sewer or drainage system. This standard addresses basic sanitation needs and promotes economic, social, and environmental sustainability through strategies that may include minimising resource consumption (e.g. water or energy) and converting human waste to a safe output. The ISO 30500 standard is applicable to the development of sanitation systems that are not connected to water and electricity networks; it can also be applied to systems that can utilise water mains and/or electricity. It also defines the basic treatable input as primarily human excreta and gives options for extending the range of input substances. Requirements for the quality of the outputs from the sanitation system are given for solid and liquid discharges, odour, air and noise emissions. ISO 30500 carries the criteria for the safety, functionality, usability, reliability and maintainability of the system, as well as its compatibility

with environmental protection goals. ISO 30500 also focuses on cutting the sanitation service chain at the containment stage, i.e. with treatment performed onsite, eliminating the emptying and transportation stages (see Figure 1).

ISO 31800 is a product standard published in 2020 for non-sewered faecal sludge treatment units with the purpose to specify performance and safety requirements of community-scale resource recovery faecal sludge treatment units serving approximately, but not limited to, 1 000 to 100 000 people. It aims to specify technical requirements and recommendations for such treatment units in terms of performance, safety, operability and maintainability. Accordingly, the standard is intended to ensure the performance, safety and sustainability of community-scale resource recovery faecal sludge treatment units, as well as technical robustness and safety in terms of human health and the environment.

The Benefits of adopting ISO standards for non-sewered sanitation systems The adoption of standards like the above has benefits for all the stakeholders involved: (1) regulators/policy makers, (2) manufacturers and (3) users (see roles below).

- 1. Regulators and Policy Makers** can rely on global expert opinion to ensure the safety of a product and/or a management process for its citizens. They can access the constantly updated source of information and experiences from around the world.
- 2. Manufacturers** have a blueprint to use in order to create a product and/or a service that meets international guidelines, making market entry easier. The adoption of product standards also increases the manufacturing capability to be widely available to market and deploy at places of need.
- 3. The Users** will have increased confidence in a product and/or a management process, reflecting the consensus of regulators, manufactures and users from across the world. The users can have a dignified, reliable, safe, hygienic, odour-free experience that may even produce by-products that can be re-used by the community.

A case study featuring an autonomous toilet without sewer connections, according to ISO 30500 and which is currently in the certification is featured in the section "Emerging Technologies" (pp. 148-151).

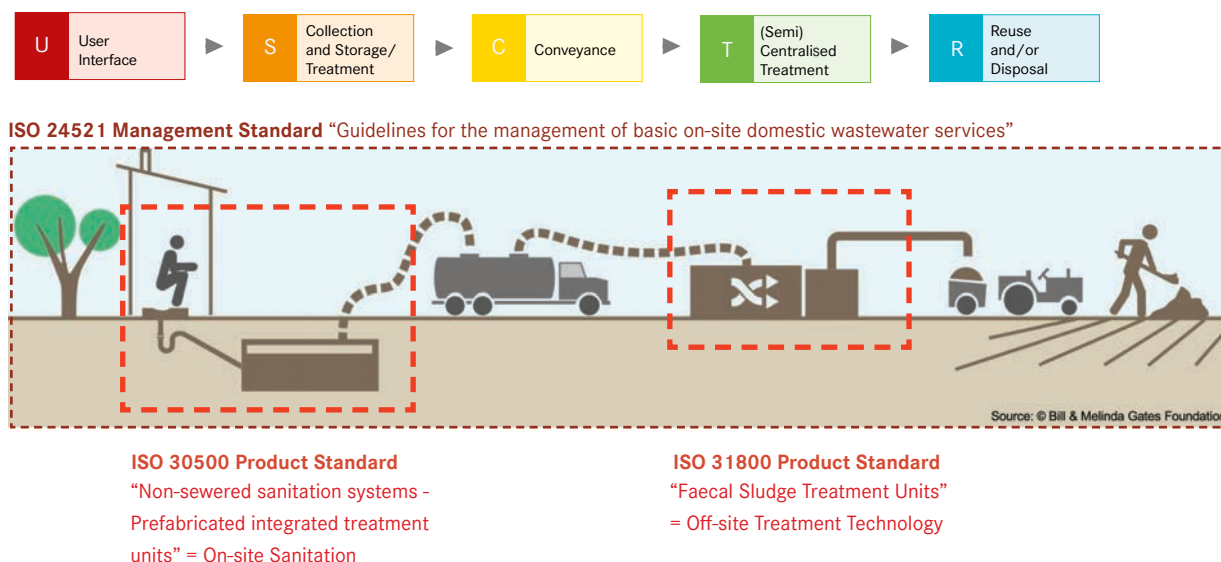

Figure 1: The role of various ISO product and management standards in the sanitation service chain

X 1.2.3 Guidelines and Certification Process for Sustainable Biochar Production and Biochar Based Carbon Sinks

Another quickly emerging area for voluntary standards backed by a certification process are the processing of faecal sludge with carbonisation to produce a quality ensured biochar and the certification of the carbon sink potential of biochar. In January 2022, the European Biochar Foundation updated the 2012 "European Biochar Certificate – Guidelines for a Sustainable Production of Biochar" (EBC, 2022). These guidelines provide an assessment mechanism based on the latest research, practices and legislation. By requiring the use of this assessment system, the European Biochar Certificate (EBC) enables and guarantees sustainable biochar production, processing and distribution. It provides customers with a reliable quality standard, while giving producers the opportunity to prove that their products meet well-defined and recognised quality standards. It also aims at providing a firm state-of-the-art knowledge transfer process, which is a sound basis for future legislation (e.g., EU fertiliser regulations or carbon-sink regulations).

Another EBC-Guideline can serve as a reference for the certification of the carbon sink potential of biochar from faecal sludge (EBC, 2020). Current CO₂ certificates usually certify the reduction of emissions compared to

a reference scenario and, thus, help to avoid emissions. On the other hand, the certification of carbon sinks guarantees the storage of carbon in the terrestrial system, which can be verified at any time. Carbon sinks are the result of the active removal of CO₂ from the atmosphere. Complete and batch-accurate tracking of each sequestered unit of carbon must be ensured to guarantee the removal of CO₂ from the atmosphere and to quantify carbon sinks. This tracking must cover the removal from the atmosphere (carbon capture), all necessary transports and transformations, and the final storage.

References & Further Reading

can be found on page 259

X 2 Climate-Resilient Water Resources Management

The objective of this RSAP-component is to ensure the sustainable and efficient management of the water resources, from ridge to reef, through the adoption of IWRM principles. IWRM is an adaptation response to a reduction in water resource and requires the incorporation of indigenous and local knowledge on water use and management with scientific knowledge to ensure the cultural appropriateness of the approaches being proposed and greater potential for successful implementation.

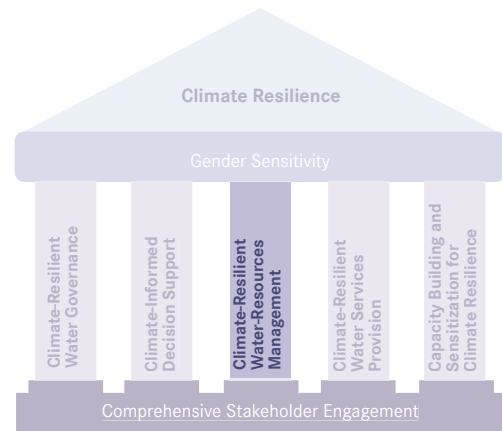

X 2.1 Integrated Sanitation and Groundwater Management

- Making the Invisible Visible -

Activity 2.2.2 to this RSAP component is to “Reduce the sources of pollution of water sources, through enactment, where necessary, and enforcement of legislation and rigorous public education.” This chapter was supported by SuSanA Working 11 “Groundwater Protection” and is shedding a light on groundwater and how to integrate this precious water source in the assessment steps of sanitation planning. Groundwater is the water found underground in geological formations of rocks, sands and gravels that can hold water – called aquifers. It is very important because it supports drinking water supplies, sanitation systems, farming, industry and ecosystems. The abstraction of groundwater represents the largest proportion of water supply, accounting for approximately 53 % of supply (RSAP, p.18). Groundwater also plays a critical role in adapting to climate change. The sustainable management of this precious resource needs the care and collective action from all members of society.

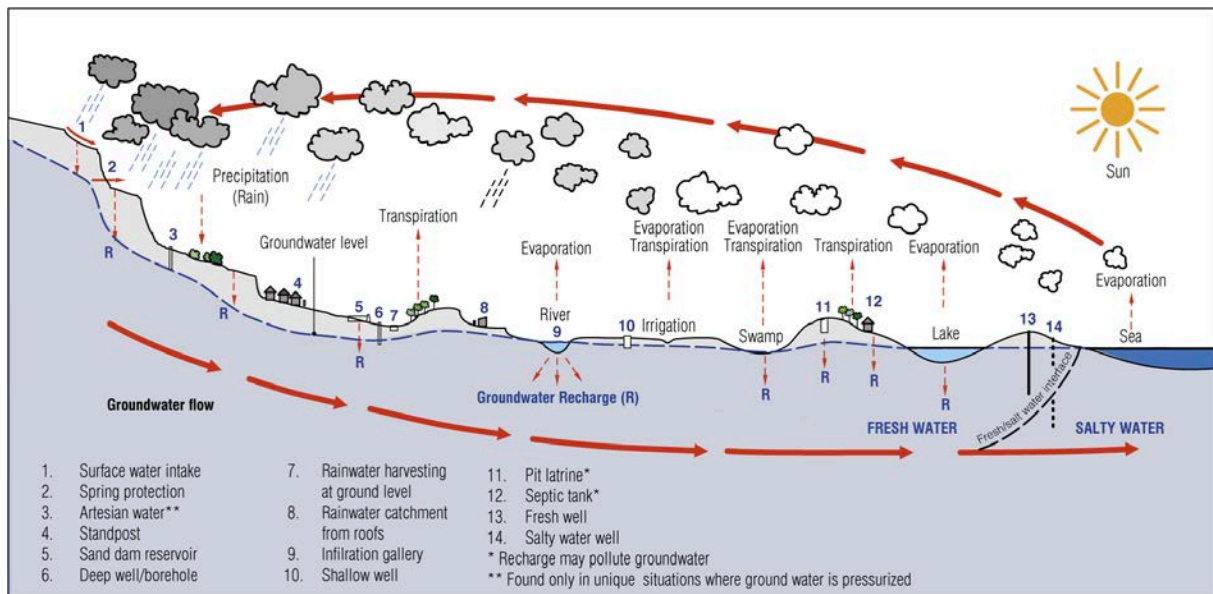

Figure 1: Groundwater flow and water cycle from ridge to reef (McMahon, G.; Chatterton, K. (2019), Loughborough University).

Professionals from all sectors need to care more about groundwater because it is being over-used in many areas, where more water is abstracted from aquifers than is recharged by rain or snow and polluted by untreated domestic and industrial wastewater.

Therefore, a reliable knowledge of existing soil and groundwater conditions is essential in sanitation planning and a key factor in the selection of appropriate technologies, especially where infiltration-based sanitation systems such as Irrigation (R.4), Soak Pits (R.5), Leach Fields (R.6) and Water Disposal/ Groundwater Recharge (R.9) are to be used. Soils with

a high infiltration capacity can be desirable from a technology and cost perspective but may be undesirable from a health and safety perspective, as they increase the risk of groundwater contamination. On the other hand, more compact, impermeable soils such as clay may severely limit infiltration and make drainage almost impossible.

The main danger is the contamination of groundwater used for drinking water by pathogens of faecal origin. Moreover, nitrate from unsealed onsite sanitation systems may also be a health hazard in areas where shallow aquifers are used as a source of drinking water.

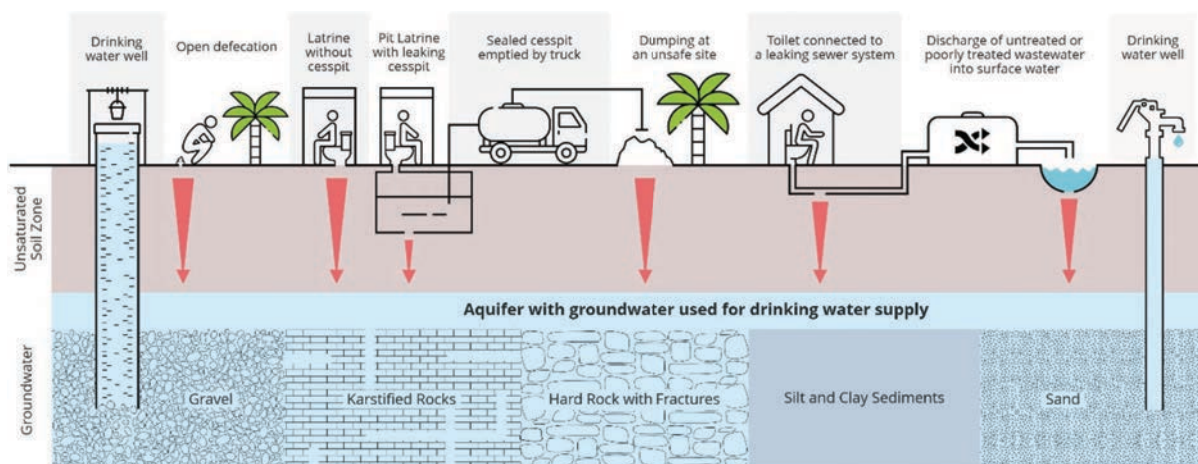

Figure 2: Potential sources of pollution from sanitation to groundwater (© SuSanA WG 11/ Athena Infonomics Infographic)

Settlement building and the development of new housing areas leads to the loss of soil permeability due to soil compaction and sealing. The result is increased runoff and a higher risk of flooding. Infiltration can also be reduced, which results in less recharge of shallow aquifers. At the same time, the installation of new sanitation infrastructure increases the risk of surface and groundwater contamination.

Two flows of bacteriological contamination must be considered simultaneously:

- contamination through runoff water flowing into a drinking water well and
- contamination of the groundwater.

Where there are no other guidelines or regulatory requirements, percolation tests may provide first-hand orientation to assess local conditions regarding the speed of movement of contaminated water through the soil (Compendium of Sanitation Technologies in Emergencies, p.163). Also assessing the soil texture (i.e. clay content) with manual inspection in different depths might provide some relevant first-hand information.

As a way forward, the Sustainable Sanitation Alliance (www.susana.org/en/working-groups/groundwater-protection) is introducing the concept of Integrated Sanitation and Groundwater Management (ISGM), which approaches decision making from a combined perspective of health, sanitation and environmental assessments (Wolf et al., 2022). The key components of ISGM include:

- Groundwater vulnerability assessment: How well is the groundwater naturally protected by soil and sediments and how easily does the aquifer transmit the contaminants?
- Wastewater management system assessment: Analyzing the sanitation service chain, especially with regard to the endpoints. This may include:
- Groundwater hazard assessment: Which contamination sources (especially from existing sanitation) exist and what are the estimated loads (concentrations)? What is the likelihood of events which may exacerbate groundwater contamination, e.g. flooding or major spills?
- Groundwater contamination exposure mapping: Which zones are at risk of abstracting contaminated groundwater, (assessed through drinking water source mapping and groundwater flow path mapping)?
- Groundwater risk assessment: Combining vulnerability, hazard/likelihood and exposure mapping to identify risk hot spots
- Integrated Sanitation and Groundwater Management assessment: Combining groundwater risk assessment and groundwater protection zoning planning (Clemens et al., 2020) with different scenarios for improved sanitation systems for medium and long-term planning (Figure 3).

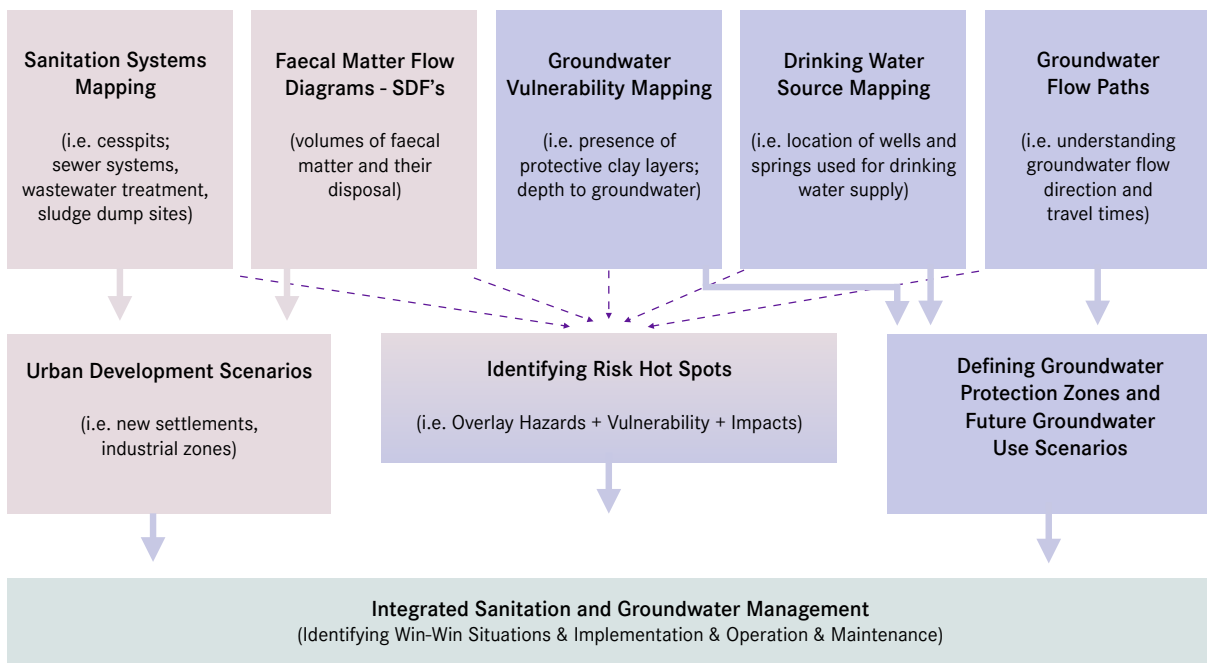

Figure 3: Conceptual framework for Integrated Sanitation and Groundwater Management (SuSanA WG11, Wolf et al., 2022).

An instructive example of an integrated assessment is documented for a case study near Irbid, Jordan (Clemens et al., 2020). The authors combined a groundwater risk assessment with a wastewater treatment management assessment to investigate different scenarios, for expanding sanitation and water supply services while

protecting the groundwater source. This eventually led to an assessment of the most economic and feasible solutions.

References & Further Reading

can be found on page 260

X 2.2 Managed Aquifer Recharge and Aquifer Storage and Recovery

The previous section advocated for integrated sanitation and groundwater management with a focus on groundwater protection. As the RSAP is enumerating “aquifer recharge” among the many opportunities for the safe reuse of treated effluent (RSAP p.16), this chapter will briefly illustrate ways of actively replenishing aquifers with rainwater. It is an important option to overcome the loss of soil permeability due to soil compaction and sealing in the built urban environment. Treated wastewater, under well controlled circumstances and precautions, may be part of that (R.9). Two of these concepts are Managed Aquifer Recharge (MAR) and Aquifer storage and recovery (ASR).

Both are man-made processes or natural processes enhanced by humans that convey water underground. The processes replenish ground water stored in aquifers for beneficial purposes. Although MAR and ASR are often used interchangeably, they are separate processes with distinct objectives. MAR is used solely to replenish water in aquifers. ASR is used to store water, which is later recovered - through the same well - for use (US EPA).

Particularly relevant for Coastal Zones in the Caribbean is the potential of MAR to mitigate seawater intrusion by the creation of hydraulic barriers.

Seawater intrusion is defined as the migration of saline water from the sea into aquifers that are hydraulically connected with the sea. Thus, seawater intrusion leads to the salinisation of freshwater aquifers along the coastlines. In simple terms:

- if the water withdrawal exceeds the natural recharge rate of freshwater or
- if seawater levels are rising, the seawater will intrude upward and landward into the aquifer and around the well (Figure 4).

Groundwater replenishment or increased groundwater stored in aquifers during wet periods can contribute to improved water supply, security and sustainability. The recovered water can be used for drinking water supply, irrigation and ecosystem restoration projects, often supplementing the surface water supply. Economically, ASR can be considerably cheaper and easier to implement than other storage methods and is very cost effective if compared to producing alternative sources of water needed for development.

References & Further Reading

can be found on page 260

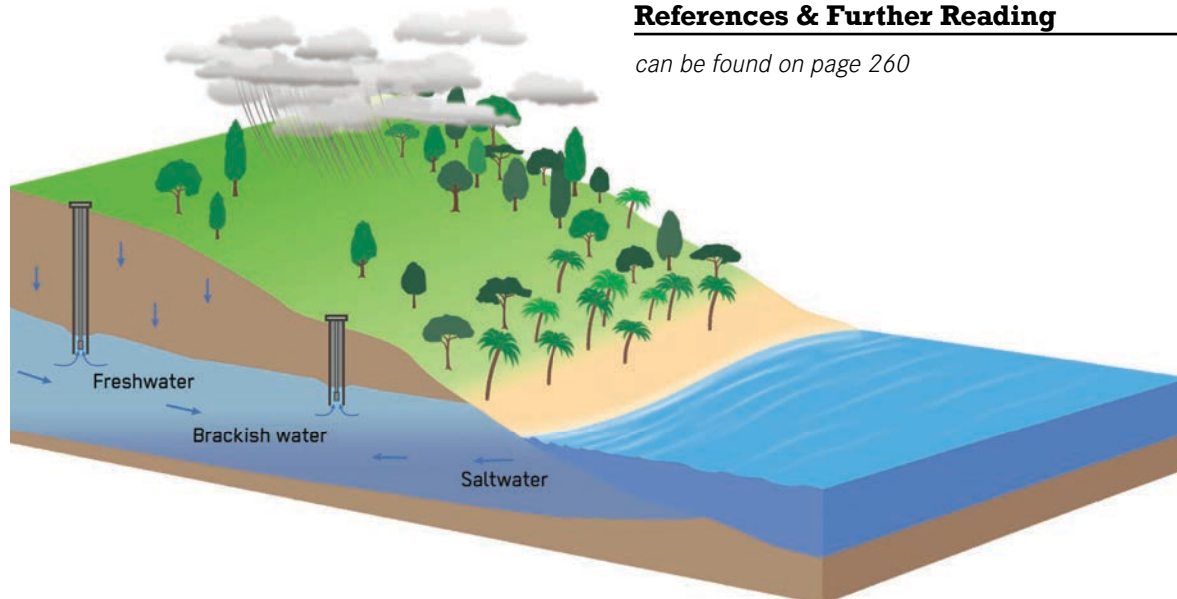

Figure 4: Model of a coastal aquifer illustrating the reciprocal relationship between seawater and freshwater
(Figure by Coerver et al., 2021)

X 2.3 Rainwater Harvesting

Modern water management relies heavily on the cost and energy intensive long-distance transfer of water to meet the widening water demand-supply gap, including overexploitation of in-situ groundwater resources or the very costly seawater desalination. While less than 1% of the Caribbean's water supply is harvested from rainwater (RSAP p.18), its importance is increasing as water availability becomes more limited and harder to predict in a changing climate (RSAP 2nd Implementation Plan, 2021, p. 8).

For the sustainable functioning of sanitation systems and technologies, water run-off from rooftops and other paved surfaces must be prevented from entering storage, conveyance or treatment technologies. In line with the interactions between water and sanitation service chains outlined above and in chapter X 4.3, undesirable effects must be prevented while positive co-benefits should be systematically promoted and improved.

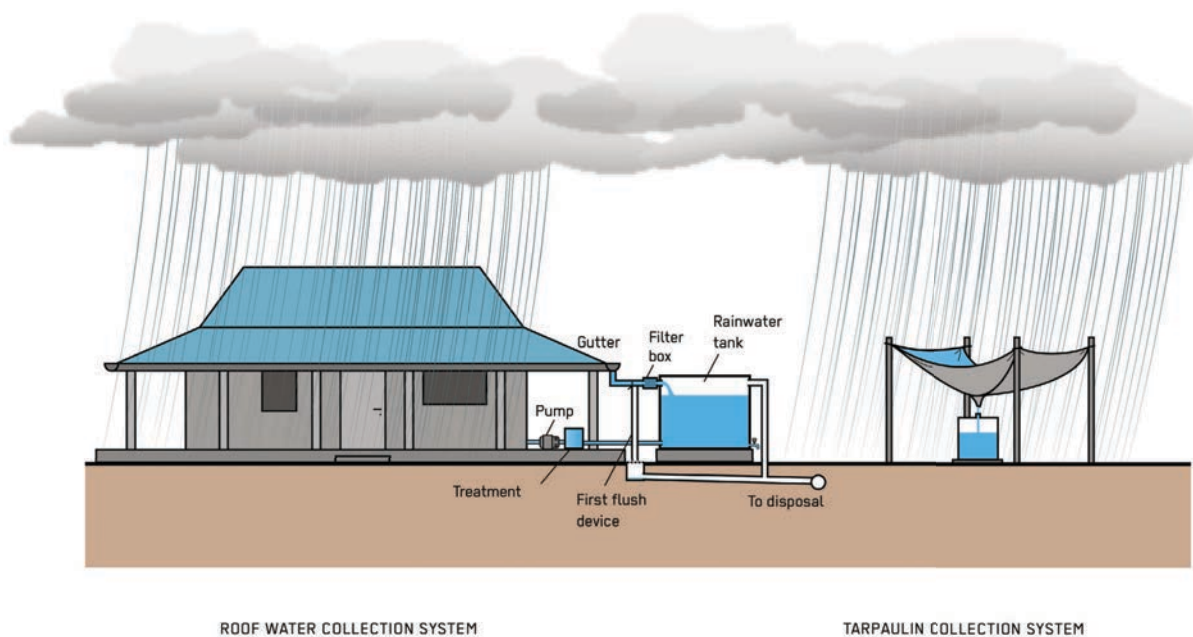

Figure 5: Rainwater Harvesting from raised surfaces
(Figure by Coerver et al., 2021)

One important resource is the Caribbean Rainwater Harvesting Toolbox. It was developed by the Global Water Partnership - Caribbean (GWP-C) in collaboration with other partners, to disseminate information on rainwater harvesting and improve knowledge on how to design and implement systems and technologies in safe and sanitary conditions. The Toolbox is a compilation of research materials and best practices applicable to the Region.

References & Further Reading

can be found on page 261

X 3 Climate-Informed Decision Support

In the RSAP, the overall objective of this component is “to facilitate the development of the robust evidence base that will be used to underpin all policy formulation and decision-making in the water sector at the domestic and regional levels. The intention here is to make the decision support mechanism open to all stakeholders, at different levels of input and access” (p. 36).

The RSAP 2nd Implementation Plan emphasises that “there should be ONE monitoring and evaluation system, at the country level, that would allow for the continuous monitoring and evaluation, with adjustments and refinement where necessary, to ensure that the Action Plan, with its various activities and interventions, is having the desired impact” (p. 54).

The following rule of three applies to the sanitation sector worldwide:

1. What gets measured, gets managed...
2. ...at least, what does not get measured, does not get managed
3. currently, very little gets measured

The value and importance of this pillar of the RSAP cannot be overstated - along with the role of municipal utilities. Both are illustrated by the following examples:

X 3.1 A lesson based on institutional developments, standards and river quality in the UK

“Undue haste in adopting standards which are currently too high can lead to the use of inappropriate technology in pursuit of unattainable or unaffordable objectives and, in doing so, produces an unsustainable system. There is great danger in setting standards and then ignoring them. It is often better to set appropriate and affordable standards and to have a phased approach to improving the standards as and when affordable. In addition, such an approach permits the country the opportunity to develop its own standards and gives it adequate time to implement a suitable regulatory framework and to develop the institutional capacity necessary for enforcement.” (Johnstone, 1996, p.220)

Lessons learned: Adopting standards should go hand in hand with capacities for monitoring, evaluation and learning. Incremental improvements on an informed basis shall follow a phased approach – in line with financial resources and enforcement.

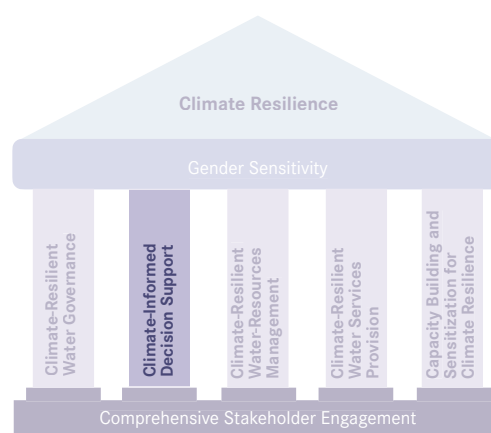

X 3.2 A lesson based on how East Asian “Tiger States” delivered sanitation within a generation

“WaterAid has looked at the case histories of some, so-called, Tiger States - Singapore, West Malaysia and South Korea - to see if there are instructive pointers for a sector needing to rethink how to deliver transformational change. At first sight, the initial conditions in East Asian states are so markedly different to those in the least developed, most off-track countries, that the value of looking at the East Asian case examples might look questionable, if not entirely irrelevant. But that would be wrong. In 1960, when South Korea made the strategic choice to push for total sanitation as central to its national development strategy, its per capita income levels were less than Ghana, Zambia, and Senegal’s. South Korea’s aid inflows were also less than Ghana’s. But also the history of sanitation development in East Asia challenges a prevailing assumption dominating international development policy - namely that access to sanitation is an outcome of development and not a driver of public health and common goods. For the East Asian Tigers, sanitation was front and centre of their national development strategies. It was formative in their nation-building project. So, how did they do it? What were some of the political and policy drivers that delivered universal access to sanitation and, importantly, hygiene practice? WaterAid’s research discerned at least five defining characteristics in East Asia’s sanitation story that are useful to consider in the drive to achieving the SDG target on sanitation in the most off-track countries.

(...) Fifth: the complexities of implementation across multiple departments and policies required a continuous and cyclical process of monitoring, analysis, and above all, coordination. This allowed national governments to

*identify performance and implementation weaknesses and to respond to bottlenecks with remedial improvements and reforms. In the countries studied, the defining feature of even some of the most centrally driven national sanitation policies was a **process of continuous local level coordination and monitoring of programmes, from design through the delivery chain, to implementation at a project level, with ongoing follow up of reforms and improvements.*** (Northover, 2016, pp. 20-22)

X 3.3 Linking local monitoring and decision-making with SDG 6 progress and reporting

The sanitation and wastewater related targets for SDG 6 are clear:

- Target 6.2. By 2030, achieve access to adequate and equitable sanitation and hygiene for all and end open defecation, paying special attention to the needs of women and girls and those in vulnerable situations.
- Target 6.3. By 2030, improve water quality by reducing pollution, eliminating dumping and minimizing release of hazardous chemicals and materials, **halving the proportion of untreated wastewater** and substantially increasing recycling and safe reuse globally.

However, the baseline is not. Quantities and qualities of untreated faecal sludge and wastewater are among the least monitored and documented basic services. An important resource is the 2021 report *“Progress on wastewater treatment – Global status and acceleration needs for SDG indicator 6.3.1”*. The two messages quoted below highlight the dilemma of municipal utilities needed as a source of data along with the overall lack of accurate knowledge about the current wastewater volumes generated and treated:

- Municipal wastewater utilities are an important consistent source of reported data, but there are currently extremely **low levels of reporting** of industrial wastewater statistics. **Data scarcity, particularly for independent treatment systems and industrial discharges**, reveals the low priority given to managing pollution from these sources.

- It is generally considered that over 80 per cent of wastewater is released into the environment without adequate treatment (World Water Assessment Programme, 2017 as cited in UN Habitat and WHO, 2021, p.2). However, such statistics have been based on very incomplete data, and more recent and thorough analyses have suggested that just under 50 per cent of global wastewater production is released into the environment untreated (Jones et al., 2021 as cited in UN Habitat and WHO, 2021, p.2).

A recent study has also suggested that the **global production of municipal wastewater is expected to increase by 24 per cent by 2030 and 51 per cent by 2050** over the current levels (Qadir et al., 2020 as cited in UN Habitat and WHO, 2021, p.2). In fact, **there is an overall lack of accurate knowledge about the current wastewater volumes generated and treated** (for examples see Sato et al., 2013 as cited in UN Habitat and WHO, 2021, p.2) because **monitoring is complex and costly, and data are not systematically aggregated to the national level and/or are not disclosed in many countries**, especially in the industrial sector (World Business Council for Sustainable Development, 2020 as cited in UN Habitat and WHO, 2021, p.2). A previous compilation of wastewater treatment statistics from various sources covering 183 countries pointed out that the **lack of consistent definitions, reporting protocols and a central custodian for wastewater treatment data** were the main reasons behind the challenges in constructing comparable performance measures (Malik et al., 2015 as cited in UN Habitat and WHO, 2021, p.2).

References & Further Reading

can be found on page 261

X 4 Climate-Resilient Water and Sanitation Services Provision

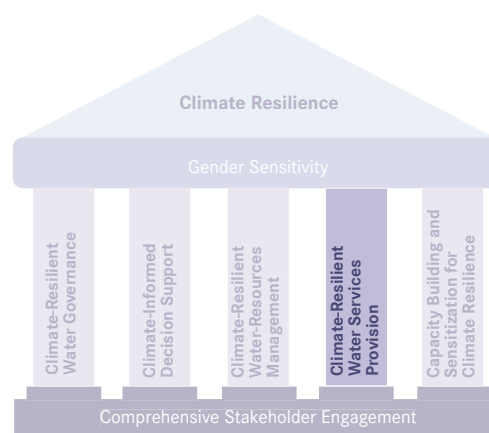

The RSAP clearly acknowledges that treated wastewater and sewage sludge are increasingly viewed as a potential resource: *“The safe reuse of treated effluent can make more water available for agriculture, aquifer recharge, aquaculture, firefighting, flushing of toilets, industrial cooling, park and golf course irrigation, formation of wetlands for wildlife habitats, and other non-potable needs. Additionally, wastewater sludge can be used as fertilizer, to manufacture construction materials and to generate biogas and biofuels (Sustainability Managers, 2016).”*

Planning and implementing sanitation systems and technologies as presented in this Compendium, aiming at reuse of water, energy, biosolids and nutrients, require not only “inter-agency and inter-sector coordination and

planning” (X 1, Water Governance), but also “planning for the end” to realise the co-benefits, e.g. through agricultural reuse, co-composting with organic solid waste or even aquifer recharge with treated effluent. This chapter is highlighting essential elements relevant to integrated planning and concept development for climate-resilient sanitation service provision:

- X 4.1 Planning sanitation systems with potential reuse or resource recovery as a starting point from the conception phase, i.e. planning from the end.
- X 4.2 Costing Principles for Sanitation Systems
- X 4.3 Other Key Areas of Environmental Sanitation
- X 4.4 Operation & Effective Asset Management
- X 4.5 Climate-Sensitive Sanitation Financing

X 4.1 Planning Principles for Sanitation Systems

Sanitation systems provide services to people. To be sustainable, these services must be economically viable, socially acceptable, technically and institutionally appropriate and protect the environment and natural resources. Technology and infrastructure are just the means to provide the aforementioned services; therefore, when planning for sanitation services, we should adopt a wholistic approach based on the following principles:

- Plan for sustainable services which serve users’ needs
- Plan sanitation systems from the end and choose appropriate technologies
- Ensure financial sustainability and effective management

Plan for sustainable services which serve users’ needs

The water and sanitation sector has traditionally centred its efforts on the implementation of projects and the construction of infrastructure, while paying less attention to the sustainable provision of services. According to a World Bank report (Kennedy-Walker et al., 2020), despite large investments in infrastructure, millions of households fail to benefit from sanitation investments because a significant number of households are not connected to sewer systems even though they are near sewer lines and could feasibly connect. In the case of Peru, this accounts for 34 % of Peruvian households. Additionally, the report shows that most unconnected households are poor, and do not have the information they need to connect. For example,

across Argentina, El Salvador, Guatemala, Honduras, Mexico, Nicaragua and Uruguay, access rates are more than 40 % lower for the poorest fifth of the population than the richest fifth. In Bolivia, the National Inventory of WWTP showed that 52 % out of 219 WWTP inspected did not operate properly and 95 % had difficulties in operation and maintenance.

The large disparities in sewer coverage in the region (see Figures 1 and 2), indicate that conventional and business-as-usual approaches and strategies to water and sanitation service delivery will not be adequate to meet the increased challenges set by the Sustainable Development Goals (SDGs). To effectively fulfil and achieve SDG 6 by 2030, adoption and mainstreaming of innovative models for expanding, improving and sustaining WASH services will need to be employed across the region (Sparkman, 2017).

The urban sanitation paradigm must be improved, by promoting a range of technical solutions—both onsite and sewer, centralised and decentralised, ensuring they are appropriate to the local realities and particular users’ needs. In other words, we must focus on service provision rather than on building infrastructure or project implementation, while considering the financial, institutional, policy, regulatory and social dimensions of the services and while harmonising sanitation solutions with related urban services (Gambrill, 2020).

In Figure 3, we present some important aspects to consider while shifting from a business-as-usual *project implementation* mindset to a *service development* mindset.

Sustainable services

The main objective of a sanitation system is to protect and promote human health by protecting the environment and preventing disease. Unlike a construction project, sanitation services do not have an end date; on the contrary, they must run permanently and in a sustainable way from environmental, social and financial perspectives. Resources are needed for the construction and operation, and maintenance of sanitation systems. For example, some systems need greater volumes of water to work than others, or the demand for energy can vary greatly among treatment technologies. Reusing reclaimed water and recovering nutrients (N, P, K) or energy (biogas), makes a sanitation

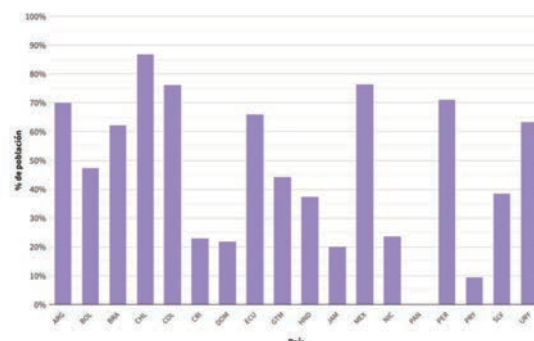

Figure 1: Proportion of households with sanitary facilities connected to sewers (www.olasdata.org)

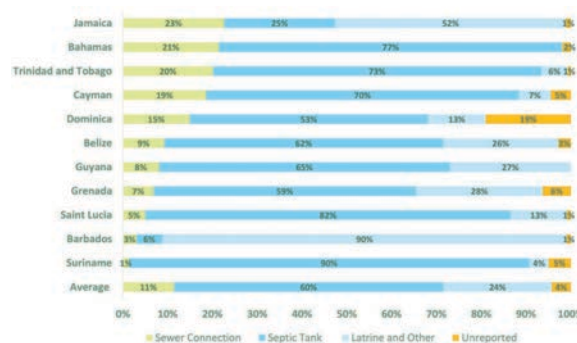

Figure 2: Percent of wastewater collection type by category (Caribbean Water Study, 2021)

system environmentally friendly and more sustainable in the long run because it saves on natural resources and/or has a smaller, or even positive impact on the natural and built environment, e.g. by strengthening resilience and disaster preparedness, improving soil fertility and the water retention capacity of catchments, as well as sequestering carbon in the soil.

Users and their needs

Sanitation systems must protect the public from disease transmission and, at the same time, they must be safe for the users and for the operators. From the user interface to the final use or disposal, all the components of a sanitation system must observe and comply with national norms and standards in relation to health and personal safety protection. When planning for sanitation systems, it is important to consider the users’ needs, drivers and demotivators. The proposed solutions will gain community support only if the drivers weigh more than the demotivators from their perspective. Table 1 shows some examples of drivers and demotivators.

Tab. 1: Drivers and demotivators in relation to sanitation system offerings

Drivers (motivators)	Demotivators
<ul style="list-style-type: none"> • Comfort and satisfaction • Improved social status • Higher property value • Avoid being fined • Reduced shame in relation to current situation or neighbours • Contribution to local development • Cleaner/healthier environment • Health/hygiene concerns 	<ul style="list-style-type: none"> • Fear of change • Additional costs and service bills • Can't afford investment • Cash-flow limitations • Does not have an opinion or not aware of others' opinion • Misinformation • Want to avoid rumours about personal wealth • Want to avoid property damage caused by household connection • Difficult procedures and requirements • Don't trust the utility or service provider

Plan sanitation systems from the end and choose appropriate technologies

The first step is to characterise, understand and quantify all inputs and outputs of the sanitation system. All the components of the system (from human interface to final use or disposal) must be designed to handle the sanitation products and they must be integrated functionally into an effective process.

User interfaces must be socially acceptable and desirable. Transport systems must be planned, according to the type of product to be conveyed, local geophysical conditions, including type of terrain and household densities.

There is no waste in wastewater. Wastewater is used water carrying resources. Both can be used, if we plan for appropriate recovery and reuse of all sanitation products. This approach involves identifying and considering all opportunities for reuse or resource recovery from the project conception phase and then work the system design backwards, hence the term plan from the end.

The level of treatment will depend on the destination, type of reuse or the desired application. For example, treated wastewater that is discharged into a lake requires a higher level of treatment than wastewater for reuse in irrigation, since to discharge treated water to a water body, which is sensitive to eutrophication (as is the case of the lake), the nutrients present in the wastewater must be removed. While, in the case of reuse in crop irrigation, these nutrients are beneficial for the soil and plants and, therefore, the level of treatment is simpler. In this second case, the soil and the plants and crops finish the water purification process and contribute to closing the water and nutrient cycles in an

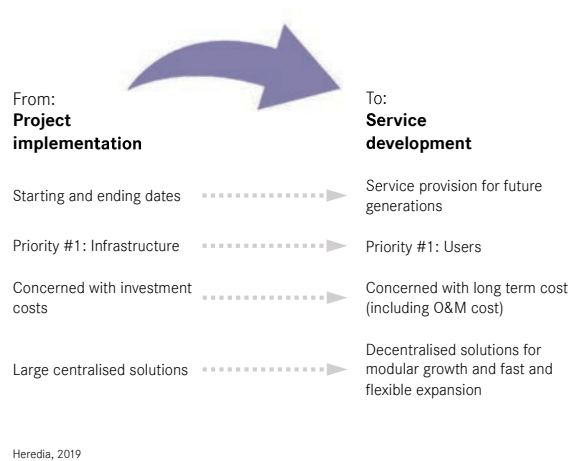

Figure 3: Classification of water-based and substrate based NBS for wastewater treatment

environmentally friendly fashion.

Once the final disposal or reuse of all outputs of the sanitation system have been defined and treatment levels established, engineers and planners can evaluate different technologies as long as they comply with the requirements.

Technologies used at each stage of the sanitation chain must be appropriate to the local context and conditions and should take into account both existing capacities and resources, as well as local constraints. When choosing technologies, it is recommended to consider the following aspects: investment costs, operation and maintenance costs, technical skills necessary for its operation and maintenance, required space (footprint area), local technical service/assistance, availability and access of supplies and spare parts, energy consumption and useful life. Compliant technologies will then have to be checked against two additional

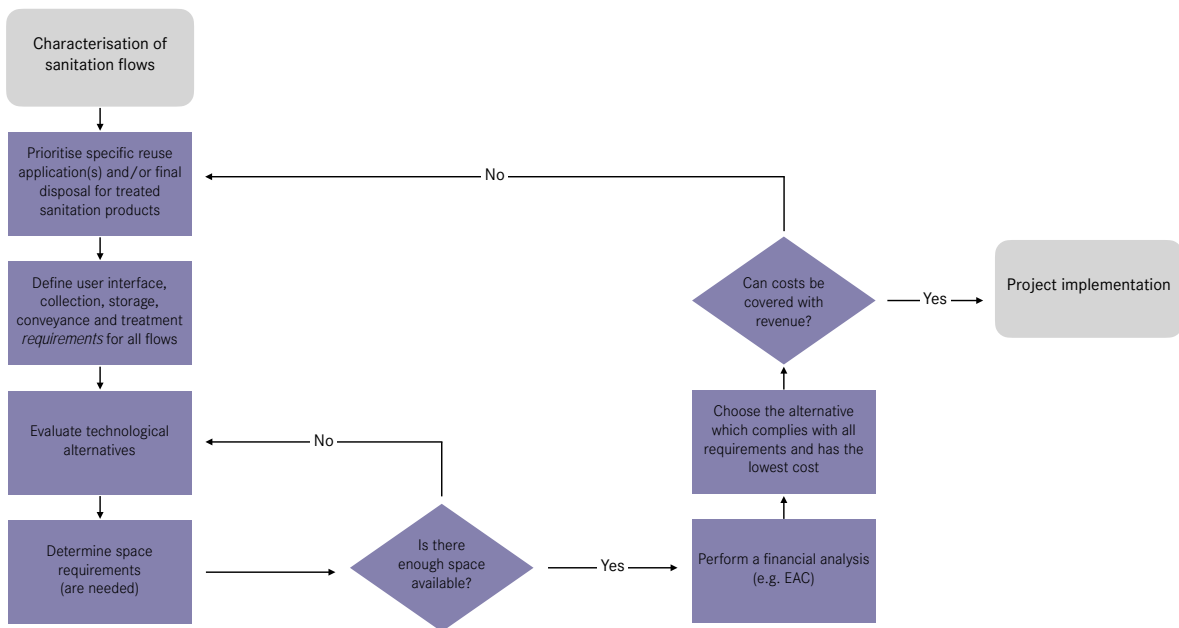

Figure 4: Planning a treatment system from the end

constraints: space and cost. Figure 4 explains this iterative process through which a viable and optimised system can be planned for.

One more aspect: even if a valuable resource (e.g. urine or rainwater) cannot be sustainably managed under current circumstances, it may be advisable to enable its future use by simple provisions in new infrastructure designs (e.g. urine diversion toilets).

Plan sanitation systems from the end and choose appropriate technologies

Financial sustainability can be achieved when all costs are covered by revenue. Costs depend highly on technology choices, the use of energy, the need of chemicals and supplies and the cost of transport. Moreover, the availability or development of a skilled workforce in operation, supervision and administration plays an essential role and is of strategic importance to the cost effective and efficient management of new assets. It is important to perform a sound financial analysis to determine all the costs generated by a sanitation system. These costs include investment costs, but also recurrent operation and management costs. See the section on Cost Principles for more information on how to assess costs and perform a financial analysis.

Effective management of a sanitation service requires roles and responsibilities to be clearly defined. At least

three main functions have to be carried out: the property function, the operation and maintenance function and the technical service function. See Figure 5 for more details on these three vital functions.

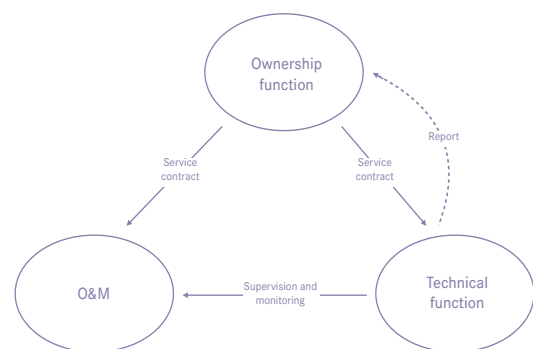

Figure 5: Functional Management Model

References & Further Reading

X 4.2 Costing Principles for Sanitation Systems

The costs and benefits of sanitation systems

Sanitation systems generate numerous benefits for human health, as well as for the environment; however, they entail a series of costs. The true value sanitation services hold for a society is usually assessed through an economic analysis, which considers all benefits and costs for the whole economy, including those which have no market price. Since the economic analysis considers all positive and negative impacts for society, it is especially useful for policy-making and public investment decisions.

On the other hand, a financial analysis compares the costs and benefits from the perspective of a project or enterprise, such as a utility or service provider. For a project to be economically viable, it must be financially sustainable. If a project or service is not financially sustainable, there will be no adequate funds to properly operate, maintain and replace assets in the long term. It must be noted that economic and financial analyses are

complementary and necessary to document all costs and benefits, including those that do not have a market price.

In this chapter, we present step-by-step directions on how to perform a basic financial analysis for the implementation of sanitation systems from a service operator perspective. This type of analysis is also useful for comparing and selecting sanitation technologies because it visualises not only the investment costs, but also the recurring operation and maintenance costs.

Financial analysis for a sanitation system

As presented in the previous sections (parts 1 and 2), sanitation systems are comprised of a series of technologies (technological components) that work together to provide sanitation services across Functional Groups, ranging from the user interface to reuse, or final disposal as shown in Figure 1.

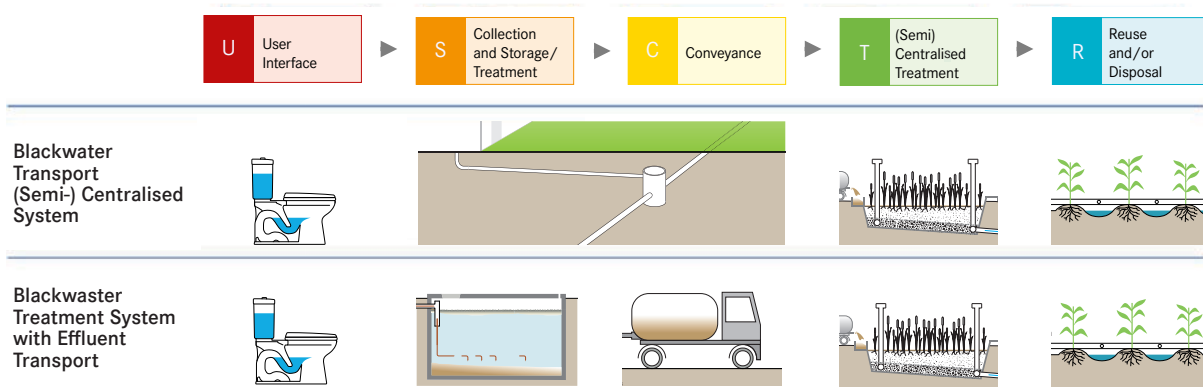

Figure 1: Sanitation systems examples

Each of the components shown in the illustration, such as flush toilets, septic tanks, vacuum trucks, sewer networks and treatment plants, which are part of the sanitation system or sanitation chain, generate costs. A financial analysis estimates the profitability of a project from an investor’s perspective. In a financial analysis, you compare the costs of the project to the expected

revenue over the project lifespan. This includes costs of financing and taxes/subsidies. Figure 2 illustrates the elements of a financial analysis.

These costs can be of two types: capital maintenance costs (CAPEX), including the costs of financing and Operation and Maintenance expenses (OPEX). CAPEX relates to the initial investment or initial outlay of a project where investment in infrastructure is made. OPEX includes all recurring cost related to labor, energy and regular maintenance, as illustrated in Table 1. The net value of the project must be greater than zero (>0) for the project to be financially sustainable. In

$$\text{Net Value} = \text{Revenue} - \text{CAPEX} - \text{OPEX}$$

Figure 2: Approach to financial analysis

other words, revenue must be greater than the sum of CAPEX, the cost of financing and OPEX. Revenue can be comprised of tariffs, taxes, transfers or revenue from trading any subproduct of sanitation systems that have a market value including the carbon sink economy.

Tab. 1: Examples of CAPEX and OPEX costs

CAPEX	OPEX
<ul style="list-style-type: none"> • Civil infrastructure • Electric installations • Pumps and electromechanical equipment • Pipes and sprinklers • Tanks and containers • Toilets • Land 	<ul style="list-style-type: none"> • Labour • Energy • Spare parts • Process and effluent monitoring • Chemicals and consumables • Office supplies • Communications • Personnel training • Technical assistance • Rentals

In order to document the costs of a sanitation system, CAPEX and OPEX costs must be determined for each and every component, which is part of the sanitation system (i.e. for each component of the sanitation service chain).

Interest rates

Interest rates are a central element in financial and economic analyses. The interest rate is the opportunity cost of capital, i.e. what is the expected return on investment of your capital if you had invested it elsewhere. Interest rates are very important to economic and financial feasibility studies, as they enable the comparison of costs and revenues at different points in time.

Discounting and annuities

Interest rates are used to compare payment streams today with payment streams in the future. Such a comparison can use one of two main methods:

- Net Present Value (NPV)
- Equivalent Annual Cost (EAC)

These methods each have their strengths and weaknesses. The NPV method is good for keeping track of cash flow and variations in costs and revenues over time. The EAC method is good for managing complex projects with many technical components with different technical life spans.

Net Present Value (NPV)

On some projects, revenues and costs vary over time, e.g. up front investments and revenues that fluctuate (in

real terms) over time. In that case, you will need to use the NPV method to calculate the difference between the present value of all future costs and the present value of all future revenues. This method will also allow you to keep track of cash flow, as the method requires you to plot all costs and revenues over time.

The calculation of the NPV allows for comparisons at present value series of future flows (income and negatives) of one or more projects and alternatives. When the NPV is positive ($NPV > 0$), it is understood that it is a profitable project and that the revenues (benefits) exceed the costs. The NPV is widely used in the sector for project evaluation and is very useful from the investor's perspective; however, there is another methodology that is more practical from the perspective of the project owner or the service provider because it expresses all the financial costs and benefits of the system in terms of annual cash flows. The methodology is called Equivalent Annual Cost.

Equivalent Annual Cost (EAC)

On a project where revenues and operating costs are constant over time, it may be an advantage to use a simpler approach than NPV. The Equivalent Annual Cost EAC method annualises all capital costs into annual payments on a loan with the economic discount rate as the interest rate. Since operating costs and revenues are identical from one year to the next, it will be sufficient to calculate the sum of the annual payment on the capital investment, the annual operating cost and the annual revenue for a single year. This total EAC is directly comparable to other alternatives calculated in the same manner. This method is especially effective when you have a project that includes many technical components with different technical life spans. You simply calculate the annual payment on each component separately and base the payment calculation on a loan with the same duration as the technical life span.

Example calculation of NPV and EAC Let us consider a small municipal treatment plant for 5000 p.e. (people equivalent) which currently serves a sewer network of about 1 000 households, treating 250 000 m³ of wastewater per year. The initial investment needed to implement this plant is presented in Table 2 (CAPEX detail). The yearly recurring costs for operating and maintaining the plant (O&M costs) is presented in Table 3.

The municipality charges an average tariff for sewage serviv of \$120/year*household from which \$70/year*household are destined to cover wastewater treatment costs. Consequently, the total annual revenue for wastewater treatment is \$70 000/year.

Tab. 2: CAPEX detail

Item	Description	Initial investment (USD)
1	Inlet works and pumping station	61 207
2	Pumps	7 315
3	Pre-treatment equipment	21 534
4	Anaerobic baffled reactor (ABR)	170 251
5	Treatment wetland	130 321
6	Chlorination system	21 552
7	Offices and road access	4 310
8	Fence	21 408
9	Electric installations	8 621
	Total	446 519

Tab. 3: OPEX detail

Item	Description	Recurring costs (USD/year)
1	Electricity costs	15 334
2	Labor	9 224
3	Water quality monitoring	319
4	Electric equipment maintenance	1 078
5	Reporting and office work	101
6	Minor tools	431
7	Potable water (from utility)	86
	Total	26 573

Based on this data, we can proceed with the NPV and EAC calculations.

NPV Calculation For the NPV calculation, we consider the following cash flows:

- A one-time initial outlay of \$(446 519) on year 0
- Recurring revenue of \$70 000/year
- Recurring costs of \$(26 573)/year

The yearly net cash flow is \$43 427/year. Figure 3 shows the cash flow of the project.

The NPV is calculated using the following formula:

Where:

$$NPV(i, N) = \sum_{t=0}^N \frac{C_t}{(1+i)^t}$$

i is the discount rate = 0.05

C_t is the net cash flow at time *t*

and *N* the total number of time periods = 30

The NPV is the difference between the present value of cash inflows and the present value of cash outflows. Due to the value of time, the NPV considers the discount rate (here the weighted average cost of capital - WACC) over the lifetime of the project, thus, presenting the annual cash flows in present values. In this case, the calculated NPV is \$210 233.74. A positive NPV indicates that the projected earnings generated by a project or investment – in present dollars – exceeds the anticipated costs, also in present dollars. It is assumed that an investment with a positive NPV will be profitable. An investment with a negative NPV will result in a net loss. This concept is the basis for the Net Present Value Rule, which dictates that only investments with positive NPV values should be considered.

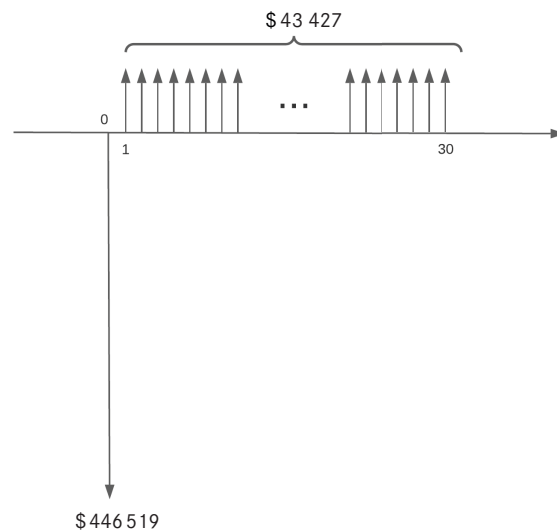

Figure 3: Project cash flow

EAC Calculation For the EAC calculation, we consider the initial investment costs, taking into account the lifespan of each component in order to annualise all capital costs into annual payments on a loan with the Discount Rate as the interest rate.

The annualised values of CAPEX are calculated using the following formula:

$$A = \frac{Po*i*(1+i)^n}{(1+i)^n - 1}$$

Where:

A = Annualised investment cost for each component

Po = Initial investment cost of each component

i = Discount Rate (yearly interest rate) = 0.05

N = Lifespan of each component (years)

Tab. 4: Calculation of annualised investment costs

Item	Description	Initial investment (USD)	(N) Lifespan (years)	(A) Annualised Capex (USD/year)
1	Inlet works and pumping station	61 207	30	3 981
2	Pumps	7 315	7	1 264
3	Pre-treatment equipment	21 534	10	2 789
4	Anaerobic baffled reactor (ABR)	170 251	20	13 661
5	Treatment wetland	130 321	20	10 457
6	Chlorination system	21 552	20	1 729
7	Offices and road access	4 310	30	280
8	Fence	21 408	30	1 393
9	Electric installations	8 621	10	1 116
	Total	446 519		36 672

The total annualised investment cost is \$36 672/year. As seen on Table 3, the yearly O&M costs (OPEX) account for \$26 573. We can conclude that the total annual cost of owning and operating the treatment plant, CAPEX + OPEX is (\$36 672 + \$26 573) = \$63 245/year. The calculation of the total annual net cost of the treatment plant is as follows:

Net annual value = Revenue – CAPEX – OPEX

Net annual value = 70 000 – 36 672 – 26 573 = \$ 6 755

This result means that the \$70 000/year revenue can cover all wastewater treatment costs and generate a profit of \$6 755/year.

The unit cost of one cubic meter (m³) of wastewater treated can be calculated by dividing the total annual cost of treating wastewater by the volume of wastewater treated in a year:

Unit cost of wastewater treatment =

\$ 63 245 / 250 000 m³ = \$ 0.25/m³

The annual per capita cost of treating wastewater can be calculated by dividing the total annual costs of treating wastewater by the number of people being served:

Annual per capita cost of treating wastewater =

\$ 63 245 / 5 000 capita = \$ 12.65/capita

Key messages

- Sanitation services generate benefits, as well as costs. An economic analysis is needed to assess and document the true costs and benefits for the society and the economy as a whole. This is particularly important to inform policy-making and public investment decisions.
- From the project or service provision perspective, a financial analysis must be done to insure the financial sustainability of the project or service provision. Two methodologies are used: the Net Present Value (NPV) and the Equivalent Annual Cost (EAC). The latter is especially useful for determining:
 - Annual cashflows (revenues and costs)
 - Unit costs e.g., cost per cubic meter
 - Annual per capita costs

The financial analysis can be performed for each component of a sanitation system. In order to assess the total costs of a sanitation solution, the costs of all components of the systems should be added.

References & Further Reading

can be found on page 262

X 4.3 Other Key Areas of Environmental Sanitation

The RSAP’s Component on “Climate-Resilient Water Resources Management” stresses cross-sector integration of planning and management approaches. As mentioned in chapter X 1 above, the RSAP calls for “inter-agency and inter-sectoral coordination and collaboration”. In fact, planning and implementation of Sanitation Systems and Technologies are intrinsically impacted by - and do impact - other key areas of environmental sanitation, i.e. drinking water supply (including rainwater harvesting), stormwater and solid waste management. The RSAP rightly advocates to agree on the establishment of “ONE national water action coordinating committee, which would bring together all the water stakeholders, across the various sectors, to agree on the steps that must be taken collectively and individually, but always in synergy, to address the myriad challenges causing water insecurity in the country.”

In the absence of stormwater management, new treatment plants become subject to hydraulic surge flows, harming treatment performance or even destroying the infrastructure. In the same way, solid waste, if not managed, tends to end up in sanitation systems, blocking pipes, screens, pumps and ponds. At the same time, integrated planning for water in its different forms, as well as sanitation and solid waste as basic public services, there is a potential for leveraging numerous co-benefits through the recovery of water,

nutrients, bio-solids and energy (e.g. co-composting of organic waste and sludge). This chapter is adopting two illustrations from a more comprehensive assessment of the advancements in integrated service provision along the lines of water, sanitation and solid waste management (Narayan et al., 2021). The illustrations visualise the various undesirable and positive interactions that could take place between the service chains for drinking water, sanitation and solid waste management (Figure 1 and 2).

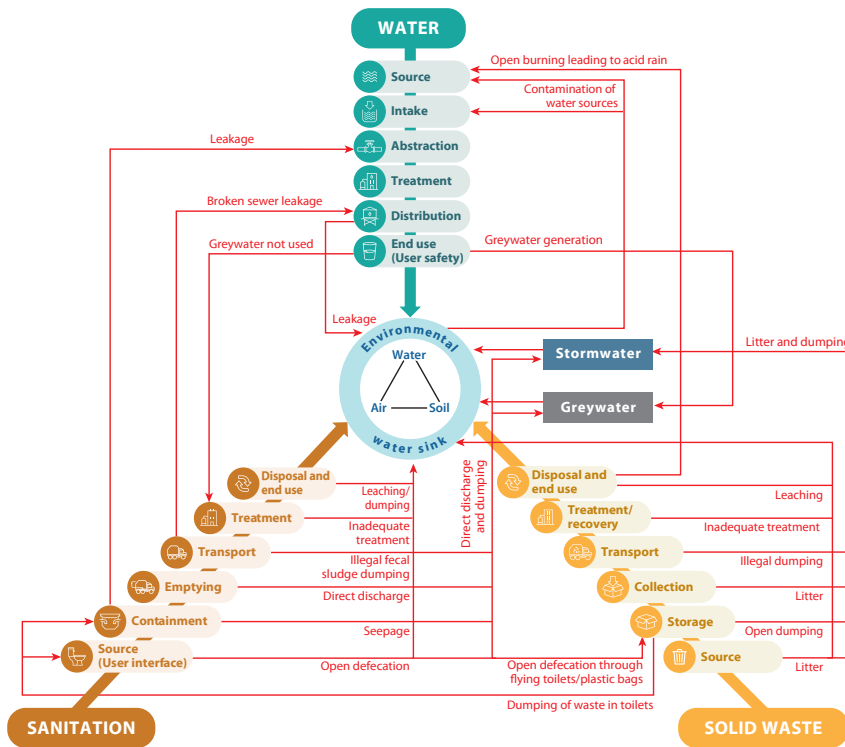

Figure 1: (Narayan et al., 2021): An illustration of the various undesirable interactions that are taking place between the three different service chains of drinking water, sanitation and solid waste. The central circle is the environmental sink of the three fundamental resources - water, air and soil - where the chains ultimately culminate. The red arrows and labels indicate the undesirable negative interactions. The Stormwater and Greywater boxes are provided separately to show their interaction with these three service chains. This Figure is illustrative, but not comprehensive, of all possible negative interactions.

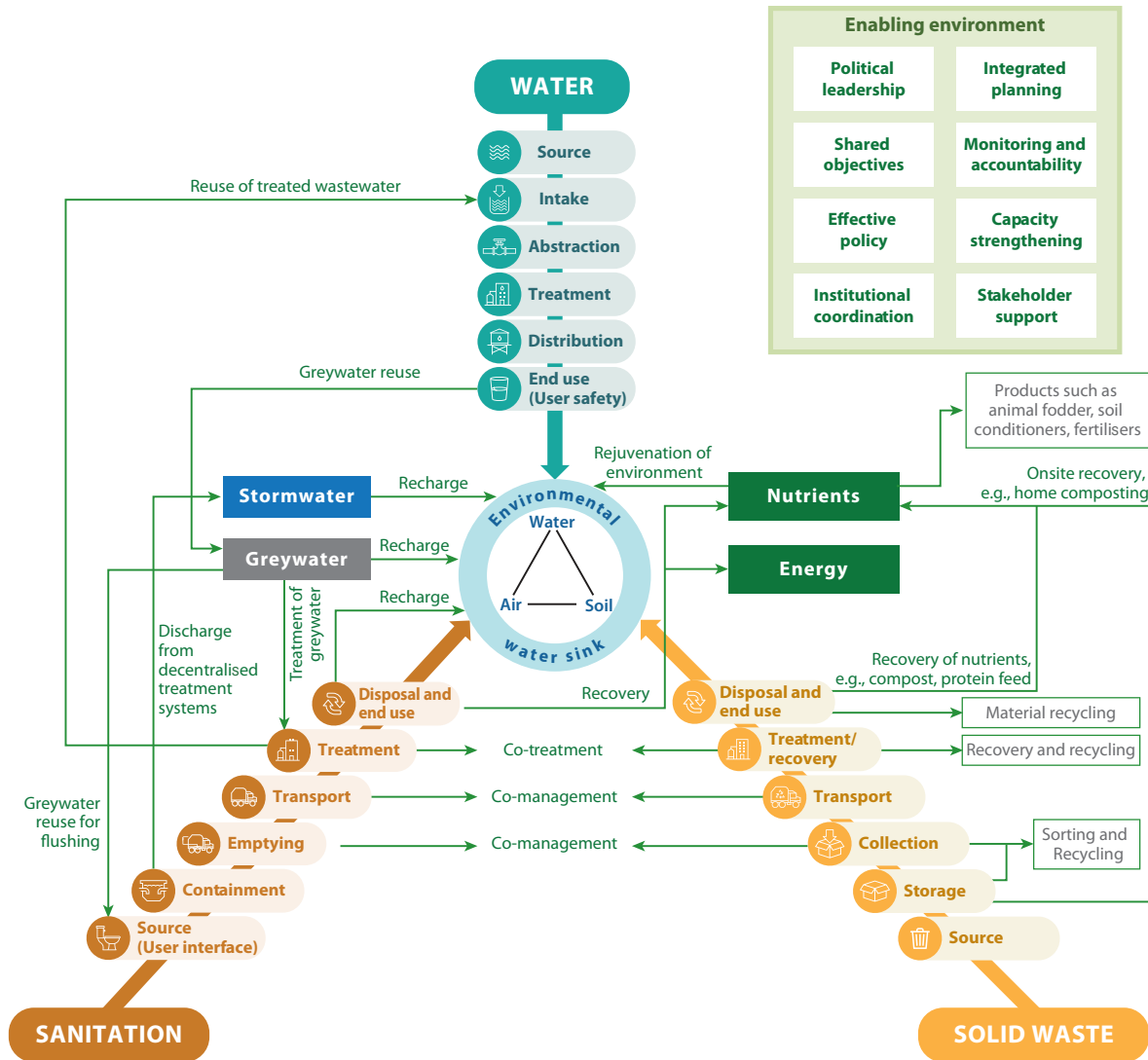

Figure 2: (Narayan et al., 2021): An illustration of the various positive interactions that could take place between the value chains for drinking water, sanitation and solid waste indicated by the green arrows. The two green boxes labelled Nutrients and Energy are desirable products that could be recovered from these chains and their interactions. Recovering, sorting and recycling can lead to further end products such as fertilisers, fodder and raw material for other uses outside of the service chains. This Figure shows that with the right enabling environment (here the eight most important factors are listed in white boxes), an integrated approach could lead to many of the synergistic outcomes to take place.

References & Further Reading

can be found on page 262

X 4.4 Operation & Effective Asset Management

The RSAP notes that “many water utilities in the Caribbean are not investing enough in their assets, a problem that is compounded by the fact that very few water utilities generate any profits because the tariff does not represent the economic cost of producing water” (RSAP, p.19).

Many water utilities are not investing enough in their assets - and even less in their asset management. Although many of the technologies presented in this Compendium do not require highly skilled operators or complex operation and maintenance (O&M), proper O&M is critical for proper plant performance. The Sustainable Sanitation Alliance enumerates five guiding principles for the design of sustainable O&M services (SuSanA WG 10, 2012):

- The level of O&M is closely linked to ownership of a facility and the basic understanding of the technology and its functions.
- Every technology that is implemented in a sanitation system requires proper O&M to function.
- Different technologies at different steps in the sanitation chain need different people and different responsibilities for O&M.
- Clearly defined roles and accountabilities as well as appropriate support and training are essential for the management of O&M services.
- Institutional responsibilities as well as effective mechanisms for cost recovery are needed to ensure

Introducing new sanitation systems and technologies and the requirements of having good O&M necessitates qualified human resources on three levels (see “Effective Management” in Chapter X 4.1):

- Service providing entity (private service operator or public utility) – service providers need clear Standard Operational Procedures for tasks to be performed on a daily, weekly, monthly or annual basis, including health and safety standards and monitoring, e.g. treatment performance;
- At the level of the asset owner (e.g. municipality) – the asset owner requires the skills to set targets,

monitor and evaluate the performance of the service provision, including deciding on corrective action;

- At the level of the regulating authority – the regulator needs the skills and capacities, e.g. to develop and monitor the performance of the relevant regulatory framework, “arbitrate” between user and service provider and take corrective regulatory action where required.

Investments in sanitation infrastructure development tend not to be accompanied by the necessary focus on the size, competencies and enabling environment for the human resource base needed to design, construct, operate, maintain, own and regulate such services to meet the target and go beyond, towards universal coverage. Standards for the safe operation and maintenance of innovative on-site domestic wastewater systems can be based on the ISO standards introduced in chapter X 1.2. This gives operators, asset owners and regulators the assurance that their management process meets the requirements for safe operation, taking into account global expert opinion.

Operation & Effective Asset Management for climate-resilient urban sanitation (Mikhael 2021, pp.59-60) should:

- Enable active monitoring and evaluation of sanitation assets.
- Carry out routine maintenance and upgrading of sanitation infrastructure.
- Ensure adequately trained human resources for operation and (adaptive) management.
- Ensure reliable supply chains for O&M of sanitation infrastructure.

More information on relevant platforms and resources by the Global Water Operator’s Partnerships Alliance (GWOPA) regarding operation, maintenance and effective asset management can be found in chapter “X 5 Capacity Building and Sensitisation for Climate Resilience”.

References & Further Reading

can be found on page 262

X 4.5 Climate-Sensitive Sanitation Financing

The RSAP dedicates a chapter to Resource Mobilisation (RSAP, pp. 41-42), reflecting on relevant approaches, strategies and agencies that may be considered to finance climate-sensitive water sector development projects in the Caribbean (including sanitation). The First Implementation Plan, in its introductory chapter, informs that *“individual countries have been developing their own national action plans and programmes and advancing with the drafting of concept notes, actively securing resources, and embarking on actions informed by and consistent with the content of the RSAP”*.

It goes on to state: *“In this regard it can be noted that there are regional organisations who are mandated to provide support to national level utilities and organisations in the form of grants and loans to advance water sector resilience to climate change and climate variability. For example, grants of up to US\$50 million can be made as well as loans of up to US\$250 million for water sector climate adaptation projects. These are just some of the concessionary funds options available, and national governments are encouraged to explore the available channels open to them for sector support, for example through the CDB, IDB and the CCCCC. Regional organisations, such as the GWP-C are already working as intermediaries, with national governments to support the development of bankable projects and to assist in approaching potential funding bodies.”*

To access climate funds, water and sanitation projects need to respond better to climate criteria. Organisations and countries must better understand the necessary requirements, agree on appropriate indicators and use the right language in their proposals to respond sufficiently to what funding institutions are seeking. For instance, all multilateral development banks now have to do GHG accounting on their projects. And they have or are developing GHG accounting tools to do that. However, when GHG accounting specialists are looking at a sanitation project, they do not necessarily understand where all the leaks, potential co-benefits or all the climate impacts happen and the differences between networked and non-networked solutions. Sanitation professionals need to educate GHG accounting specialists and vice versa. This agenda must be driven forward collectively and concomitantly.

Multilateral Development Banks are systematically incorporating climate mitigation and adaptation measures in their projects. For instance, in its “Lines of Action”, IADB’s “Water and Sanitation Sector Framework Document” supports the development of tools, methods and models (quantitative or qualitative) for the assessment and simulation of water quality and availability (including aquifers) and the different uses of water, for use in the planning, design and operation of water and sanitation infrastructure, including the sustainable management of rainwater drainage and solid waste. Innovative interventions incorporating circular economy

principles, addressing collection, handling and wastewater treatment needs are promoted, along with infrastructure that mitigates greenhouse gas emissions and is resilient to climate change (IADB, 2021).

This is generally supported through a set of operational activities that include:

- Technical assistance to improve water and sanitation solutions to meet the challenges of the sector, including training for stakeholders (service providers and users).
- Design of action plans for companies to improve their operational, commercial, technical and financial management, with technical assistance for their implementation, including management and innovation tools.
- Design and support for innovative technical solutions and financial schemes that allow companies to recover operation and maintenance (O&M) costs, efficiency in the expansion of services, including wastewater treatment, reuse, green infrastructure, co-generation of energy and use of rainwater.
- Strengthening of community management schemes for water and sanitation services for rural and small local systems through boards or associations, developing and implementing technical and financial support schemes, especially in the post-construction phase of works, that guarantee O&M.

References & Further Reading

can be found on page 262

X 5 Capacity Building and Sensitisation for Climate Resilience

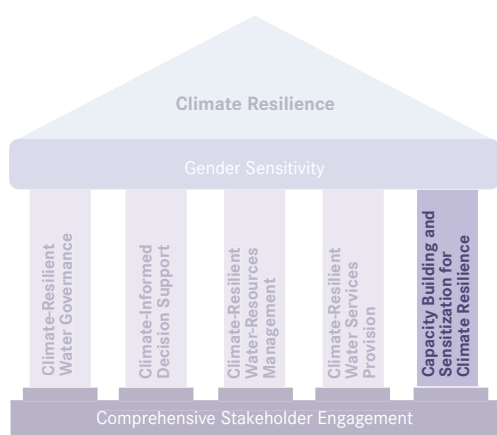

This component of the RSAP aims to increase the learning and development capacity within utility companies and stakeholders in Member States to be able to develop climate-resilient water sector strategies across the Caribbean and address the impacts of climate change. An important component is that of Monitoring and Evaluation as part of Capacity Building. This acknowledges the role of regional institutions and in particular the CWWA in monitoring and reporting back to Ministers on the progress in respect of the development and implementation of the RSAP.

A number of platforms offer trainings, tools and further publications, all complementing this compendium, and adding to the growing body of opportunities for individual or collective capacity development. Some are presented below:



GWOPA - the Global Water Operators' Partnerships Alliance (hosted by UN-Habitat) Platform for capacity building and knowledge exchange on operation and maintenance.

WOP-LAC is the regional platform for Latin America and the Caribbean. The Secretariat is hosted by AySA (Agua y Saneamientos Argentinos), as a contribution to ALOAS (Asociación Latinoamericana de Operadores de Agua y Saneamiento), and it receives the permanent support of GWOPA and IDB.



Cari-WOP is WOP-LAC's regional platform in the Caribbean. The permanent Secretariat is co-hosted by CAWASA and CWWA. The online platform for the Global WOPs Community dedicated to discussions, exchange and co-creation is also open to individuals and can be accessed via <https://gwopa.org/covid-19/workplace/>. UN-Habitat's hosted four webinars in the region on "Setting the Agenda for Wastewater Treatment and Monitoring in the Context of SDGs: Urban Wastewater 2030". The outcome report is available with CAWASA.

The 2021 4th Global WOPs Congress virtual venue can be visited at <https://gwopa.org/wop-congress/> and www.youtube.com/user/GWOPChannel/videos



Caribbean Community Climate Change Centre (CCCCC) – Regional Centre of Excellence Information, Trainings, Tools and executing agency for projects related to Climate Change

Based in Belize, the CCCCC offers updated information on climate change in the Caribbean. The publication "Spotlight on Caribbean Climate" started with Volume No. 1, Issue No. 1 in October 2021, featuring a water-focus with activities in Barbados funded by the Green Climate Fund (pp. 14-15). It is available at: <https://viewer.joomag.com/spotlight-on-caribbean-climate-volume-1-issue-1/0033026001635180261?short&>

CCCCC also offers information and training on different climate-related subjects, including online courses on topics, such as bioenergy (www.caribbeanclimate.bz/education/online-bio-energy-course/). Specific tools to assess climate risks or potential for climate-related action in the Caribbean context are available at:

www.caribbeanclimate.bz/caribbean-climate-change-tools/.



Community-Led Urban Environmental Sanitation : CLUES Complete Guidelines for Decision Makers with 30 Tools

CLUES presents a complete set of guidelines for sanitation planning in low-income urban areas. It is the most up-to-date planning framework for facilitating the delivery of environmental sanitation services for urban and periurban communities. CLUES features seven easy-to-follow steps, which are intended to be undertaken in sequential order. Step 5 of the planning approach relies on the Compendium, applying the systems approach to select the most appropriate technological option(s) for a given urban context. The document also provides guidance on how to foster an enabling environment for sanitation planning in urban settings.

By Lüthi, C., Morel, A., Tilley, E. and Ulrich, L. (2011). Eawag (Sandec), WSSCC, UN-HABITAT. Free PDF available at: www.sandec.ch/clues

Energy Performance and Carbon Emissions Assessment and Monitoring Tool



Energy Performance and Carbon Emissions Assessment and Monitoring Tool (ECAM)

ECAM is an open-source tool developed under the Water and Wastewater companies for the Climate Change Mitigation (WaCClim) joint initiative by GIZ and IWA. It is designed to quantify and evaluate GHG emissions of water and wastewater utilities at a system-wide level, allowing for an identification of opportunities for reducing energy consumption and the overall footprint of the utility. Earlier versions of ECAM focused on conventional water and wastewater systems only; however, non-sewered sanitation has been incorporated since version 3.0.

For more information visit: <https://wacclim.org/ecam-tool/>

CRew+ Academy

A platform for all training initiatives within the GEF CRew+ project.

The bilingual platform (en/es) offers short and free courses geared towards implementing Integrated Water and Wastewater Management (IWWM) solutions for a clean and healthy Caribbean. Target groups are professionals from ministries, service companies, associations and regional organisations. Past courses are available under the Resources section.

For more information, visit: <https://academy.gefcrew.org/en/>

eawag aquatic research



Online education and training

Professional Online Training from basic to advanced levels. Planning & Design of Sanitation Systems and Technologies with certificate (optional) on coursera platform

- www.youtube.com/c/SanitationMOOC (con subtítulos en español)
- www.youtube.com/c/Capacitydevelopmentforinclusiveurbansanitation
- www.coursera.org/learn/sanitation

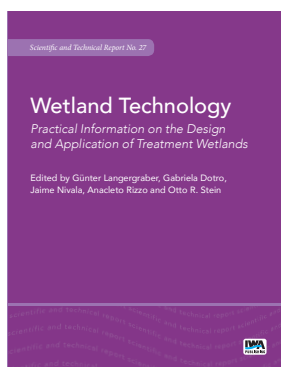

Wetland Technology

Practical Information on the Design and Application of Treatment Wetlands

This book is referenced in all Nature-Based Solutions of this Compendium. The content of the IWA Scientific and Technical Report (STR) No.27 on Wetland Technology includes useful information for practitioners and researchers, aiming to design treatment wetlands (TWs). This STR was conceptualised and written by leading experts in the field, more than 50 wetland colleagues from academia and practice contributed. The STR presents the latest technology applications within an innovative planning framework of multi-purpose wetland design. It also includes practical design information collected from over twenty years of experience from practitioners and academics, covering experiments at laboratory and pilot-scale up to full-scale applications.

By Langergraber, G., Dotro, G., Nivala, J., Rizzo, A., Stein, O.R. (Eds.) (2019). IWA Publishing. Free PDF available at: <http://dx.doi.org/10.2166/9781789060171>

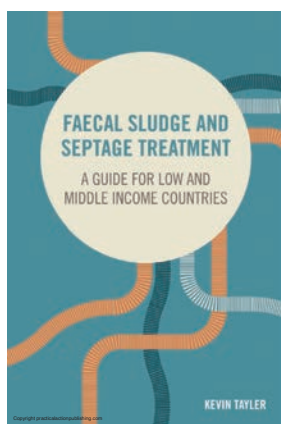

Faecal Sludge and Septage Treatment

A guide for low and middle income countries

This book is referenced in many treatment technologies in this Compendium. Most people globally continue to use various forms of on-site sanitation. These require periodic emptying and the material removed from them must be treated before reuse or discharge to the environment. The book discusses the urban contexts that influence treatment requirements and overall septage treatment processes. It examines the options and design approaches at each stage of treatment, from reception, through preliminary treatment, solids – liquid separation, anaerobic and aerobic treatment of the separated liquid and solid fractions, to systems to render treated products suitable for reuse in either agriculture or as a fuel. The book provides straightforward guidance on the options for faecal sludge treatment and the choices between those options. All concepts and approaches are clearly explained, making it accessible to a non-specialist readership. It is essential reading for planners and engineers working in local government; specialist central government departments; NGOs and consulting firms working on the planning and design of septage treatment plants and researchers and students studying urban sanitation.

By Tayler, K. (2018). Practical Action Publishing, Rugby, UK.,

Free PDF available at: <http://dx.doi.org/10.3362/9781780449869>

**sustainable
sanitation
alliance**



SuSanA – Sustainable Sanitation Alliance

SuSanA is an informal network of people and organisations that share a common vision on sustainable sanitation and want to contribute to achieving the Sustainable Development Goals, in particular SDG 6. SuSanA connects more than 14 000 individual members and 360 partner organisations (NGOs, private companies, multilateral organisations, government agencies and research institutions) to a community of people with diverse expertise and opinions. SuSanA also serves as a sounding board for innovative ideas. Finally, SuSanA contributes to policy dialogue through joint publications, meetings and initiatives. Members can receive updates on SuSanA activities and discussions that interest them, take part in the discussion forum and become active in the thematic working groups. For instance, chapter X 2.1 “Integrated Sanitation and Groundwater Management” was co-written by SuSanA Working Group 11 (Groundwater Protection). Stakeholder outreach and translation of this Compendium was supported by the SuSanA Latinoamérica Regional Chapter. The SuSanA website – with its library, project database and discussion forum – is an important resource for anyone wanting to explore the possibilities of sustainable sanitation. For more information, visit: www.susana.org/en/

X 5a Research and Development

This RSAP component seeks to encourage applied research and development and the use of technology and innovation to improve the management of water resources, facilitate better informed decision-making, improve the cost-effectiveness of operations and create greater resilience to the impacts of climate change. Its focus is to establish a mechanism to coordinate research, identify research needs and engage in corresponding proposal development.

The RSAP Implementation Plans observe that *“few water utilities actively engage in and support research related to their operational challenges. At the same time regionally based researchers have limited access to research funds, and often these are part of research grants to organisations and universities not based in the region. In other parts of the world funds have been set up to support and encourage research. The first step will be to review funding initiatives from other regions and to consider the practicality of setting up a regional research fund, an appropriate fund-raising vehicle and an estimation of the funds that could be raised”*. to support the development of bankable projects and to assist in approaching potential funding bodies”.



The Virtual **Caribbean Science Symposium on Water**, the first of its kind for the region, was hosted by the Global Water Partnership–Caribbean during 3 days in March 2021. Intended as a contribution to the RSAP and other related regional or sub-regional programmes, policies, strategies and action plans relating to water resources management, it included a roundtable discussion on wastewater management supported by inputs from The Nature Conservancy and the GEF-CReW+ project. The Symposium is well documented and has produced a number of Perspectives Papers and other publications, including all presentations.

More information available at:

www.caribbeanwater.com and www.gwp.org/en/GWP-Caribbean/



Academic education on the sanitation systems and technologies presented in this Compendium are also offered by the Global Sanitation Graduate School (GSGS) in collaboration with a growing number Universities worldwide. Starting in May 2022 with a new MSc Program in Sanitation and Sanitary Engineering, **GSGS opens a new chapter in Latin America** at the UTEC (Universidad Tecnológica del Uruguay). GSGS is a platform to facilitate the development and empower the dissemination of knowledge on sanitation through postgraduate (MSc) programs, online (self-study and instructor-led) courses, face-to-face (on-campus) courses and tailor-made training. It is intended to include any other program that focuses primarily, or at least in a substantial part, on city-wide inclusive sanitation (CWIS) including non-sewered sanitation (NSS) and faecal sludge management (FSM), i.e. sanitation systems and technologies featured in this Compendium. Joining the GSGS platform with a new Chapter in the Wider Caribbean Region might be an efficient way to fast-track research and development and strengthen capacities to implement sanitation solutions guided by the RSAP and other related regional action plans. More information available at: <https://sanitationeducation.org>

For this section, six Case Studies were selected:
five from the Wider Caribbean Region and one from Latin America.

- Case 1: Nature-Based Wastewater Treatment for New Housing Developments in Penonome, Panama
- Case 2: Integrated Management of Wastewater and Biosolids in a Slaughter House in Leon, Nicaragua
- Case 3: Semi-Centralised Wastewater Treatment for New Housing Developments in Nindiri, Nicaragua
- Case 4: Wastewater Treatment and Reuse for Golf Course Irrigation in a Large Beach Resort in Punta Cana, Dominican Republic
- Case 5: Water Savings and Sustainable Sanitation with Container-Based Sanitation for a Periurban Community at Lake Atitlan, Guatemala
- Case 6: Wastewater Treatment and Reuse for Crop Irrigation at Municipal Level in Tolata, Bolivia

The selection was based on the following criteria:

1. Size: small to medium systems
2. Character: innovative and non-conventional
3. Non-sewered: beyond current utility service structure
4. Nature-based: enabling re-use
5. Numbers: for co-benefits and revenue sources (requested)
6. Compendium: reflecting Systems & Technologies presented

All case studies are real scale nature-based solutions, enabling the re-use of water, energy and nutrients in parts or entirely. They range from a Container-Based Sanitation system with a manual household collection service in Guatemala to a large scale tourist spot in the Dominican Republic.

Case Study 2 features the application of treatment technologies presented in this Compendium for high-strength organic wastewater from a municipal slaughterhouse. While the sanitation systems and technologies presented in this Compendium largely focus on domestic wastewater from households and public institutions or hotels, this case study encourages practitioners to envision and design systems beyond the household; it is an example of how to solve the most polluting organic wastewater problems with nature-based solutions.

The Annex III on Domestic Wastewater in the LBS Protocol to the Cartagena Convention (see pp. 173-174), explicitly covers “discharges from small industries, provided their composition and quantity are compatible with treatment in a domestic wastewater system” (LBS Protocol Annex III, A.1 [c]). Case Study 2 shows how this can be done.

The following structure applies for all Case Studies:

- **General aspects** including visual overview
- **Planning process**
- **Technical Aspects** including System Diagram and Layout
- **Institutional and regulatory aspects**
- **Financial aspects**
- **Success/failure factors or lessons learned**

In this way, the selected case studies illustrate all the aspects and elements presented in the previous chapters of this Compendium and offer visual insight into potential solutions.

Case 1: Nature-Based Wastewater Treatment for new Housing Developments in Penonome, Panama



General aspects The urbanisation process in Panama in recent years has increased the demand for wastewater treatment systems. The complexity of operation and maintenance processes in conventional systems and the need for qualified personnel and electromechanic equipment entail a series of difficulties for utilities and private operators, as well as high energy costs. Conventional grey-infrastructure systems often result in the loss of large investments due to abandonment. In this context, nature-based solutions emerge as efficient, low-cost alternatives. This is the case of Floating Treatment Wetlands (FTW T.10 in this Compendium). In Panama, it is usually referred to as Green Floating Filters.

This technology has been approved by local authorities, including the National Institute of Water and Sewer, the Ministry of Environment, Ministry of Health, Ministry of Housing and the Municipality of Panama.

“Paseo del Bosque”, is an eco-neighbourhood in the Penonom Region, comprising 216 households which generate 324 m³/day of municipal type wastewater

that must be treated locally before the effluent can be discharged to a nearby natural water course.

The project was implemented by Green Engineering Corp. and FG Guardia, two Panama-based companies specialised in the design and construction of nature-based wastewater treatment plants.

Planning process The guiding principles for choosing the technology and designing the treatment system were: i) Low O&M costs, ii) Natural processes, iii) Prevent the generation of bad odours and iv) Landscape integration.

Figure 1 shows the logic of the sanitation system: households have flushing toilets and discharge wastewater to a conventional sewer network that conveys all wastewater to the treatment plant and the treated effluent is discharged to a nearby water course.

All local regulations were considered from the outset to guarantee that the treated effluent would comply with

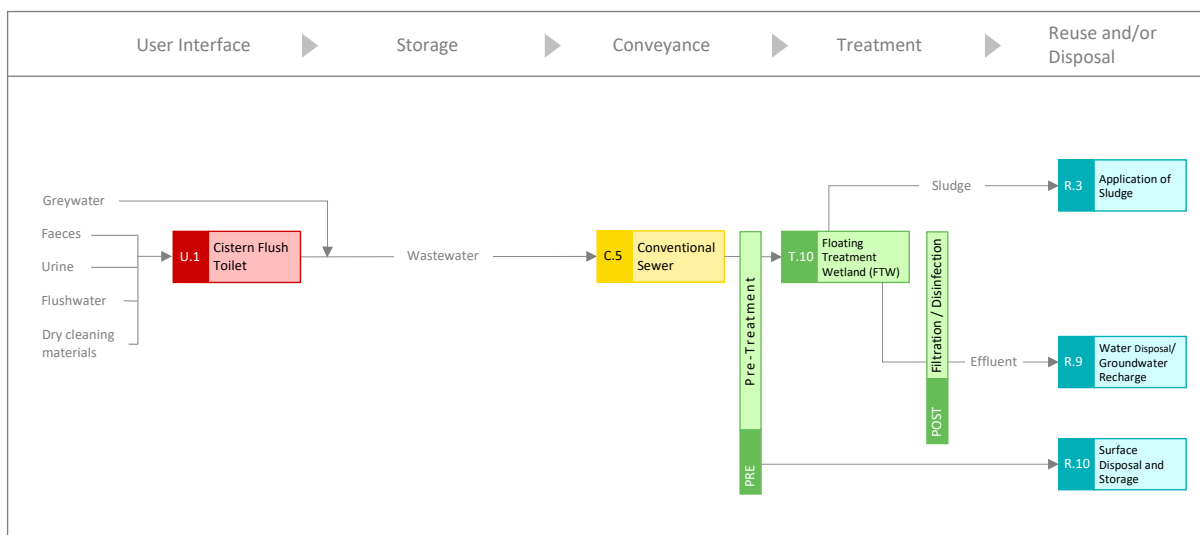

Figure 1: System diagram

discharge standards and the construction phase started only after the public authorities approved the project. Wastewater treatment based on Floating Treatment Wetlands eliminates the need for electricity, does not require electromechanical components or chemicals and is environmentally friendly. Systems that do not use equipment or energy generate less operation and maintenance costs, making their operation financially viable in the medium- and long term.

Technical aspects The Floating Treatment Wetland system has been implemented as described in technology sheet T.10 (FTW) in this Compendium. The main variables for designing such a system are: i) wastewater characteristics including organic load, ii) type of terrain, iii) flow of water and iv) the type of water course where the treated effluent is discharged. The main components of the treatment train are:

- Preliminary treatment unit to remove all non-biodegradable solids
- Floating filter wetland, to treat wastewater to an appropriate level
- Outlet works for discharging treated effluent to a waterway

The treated effluent complies with the Standard for the Discharge of Liquid Effluents to Continental and Marine Water Bodies of Panama (COPANIT-35-2019). The following parameters are monitored at the inlet and outlet of the plant: BOD₅, COD, TSS, N and P.

To determine the treatment efficiency of the plant, an analysis was conducted in August 2021. The results of the monitoring are presented in Table 1. Table 2 shows the concentration of nutrients (N-NH₃ and P) in the effluent.

Tab. 1: Water quality monitoring

Parameter	Inlet	Outlet	Limit	Global efficiency
BOD ₅ [mg/l]	220	9.70 ± 0.16	50	95,5 %
COD [mg/l]	420	16.50 ± 1.4	100	96,0 %
TSS [mg/l]	220	<7.00 ± 3.0	35	96,8 %

Tab. 2: Nutrient content in the effluent

Parameter	Effluent	Limit
N-NH ₃ [mg/l]	1.4 ± 1.0	15.0
P [mg/l]	1.29 ± 0.52	10.0

Institutional and normative aspects The United Nations Water Report (WWAP, 2018) concludes that nature-based solutions have great potential to face the current and future challenges of water resource management, as reflected in the 2030 Agenda for Sustainable Development, the SDGs and their targets. Floating Treatment Wetlands (filtros verdes flotantes in Panama) have been approved and are supported by the Ministry of Health (MINSa), Institute of National Aqueducts and Sewers (IDAAN) and the Ministry of Environment (MIAMBIENTE). These systems are considered green infrastructure.

The Ministry of Housing of Panama promotes the use of this technology, through Decree Law No. 150-2020. This corresponds to the New National Regulation of Urbanizations, Plots and Lots, which allows for the use of public areas for nature-based systems. In addition, they are considered to be green infrastructure.

Financial aspects The total investment cost (CAPEX) of the treatment plant was \$232 559. The total operating costs (OPEX) are \$855/month, which translates into \$0.86/m³.

Success/failure factors and lessons learned One of the main success factors has been the integration of the system in the landscaping of the condominium, because it is part of the green areas and does not generate any odours. Low investment costs and easy operation and maintenance make this technological alternative very attractive.

References & Further Reading

can be found on page 263

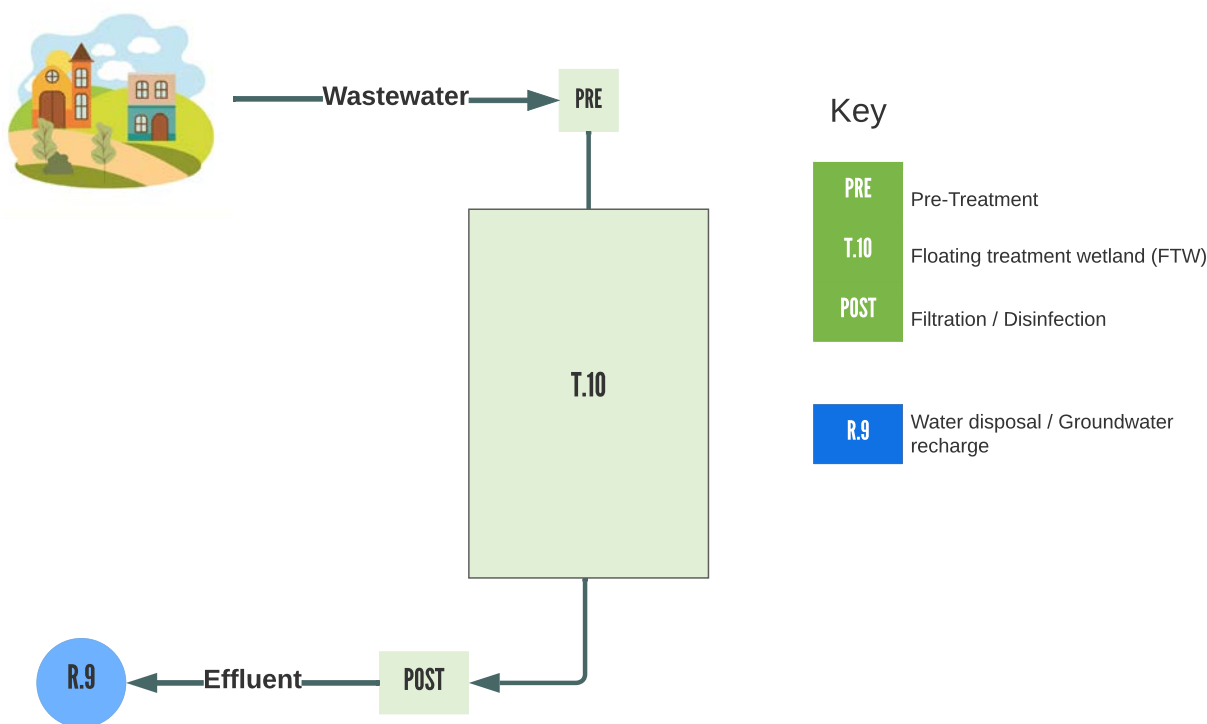

Figure 2: System layout

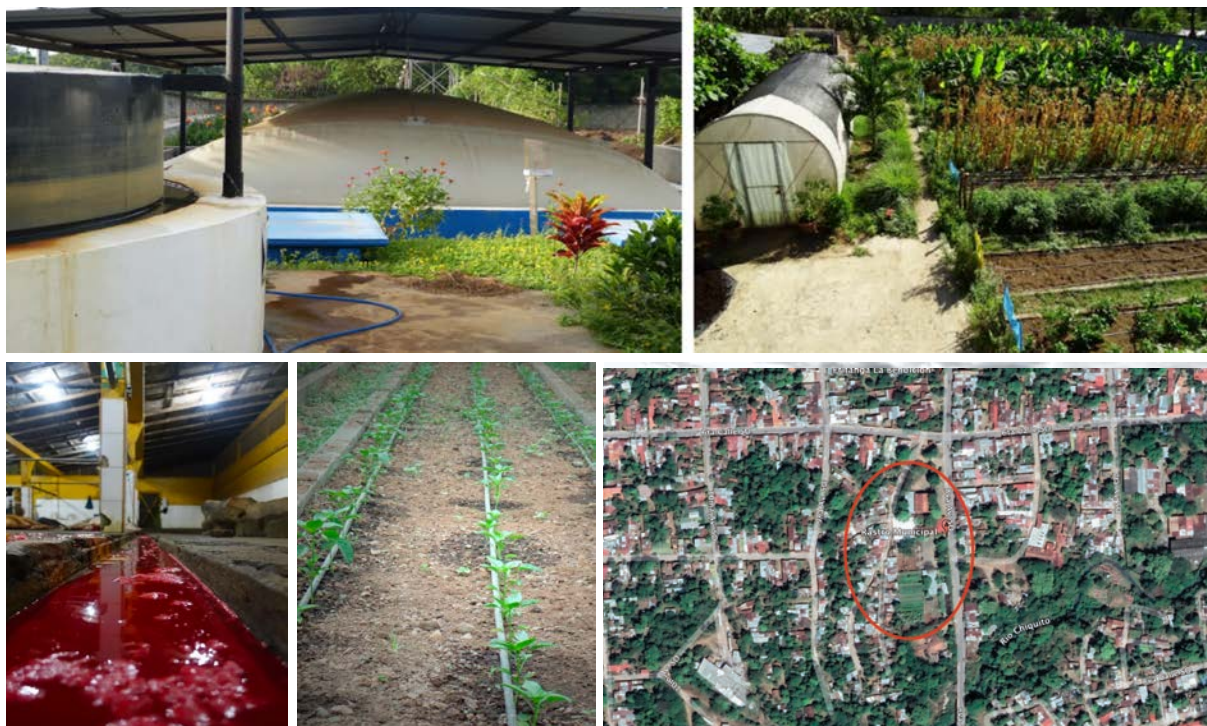

Figure 3: The Nature-Based Solution for wastewater treatment in Penonome is part of a larger housing development that will be built in the coming years. Further treatment systems will be added as construction progresses.



Figure 4: Overview of the individual construction steps. Earthworks, laying of the geotextile, installation of the watertight geomembrane as well as planting of macrophytes, commissioning and fully operational floating treatment wetland.

Case 2: Integrated Management of Wastewater and Biosolids in a Municipal Slaughterhouse in León, Nicaragua



General aspects This case study features the management of organic wastes from a slaughterhouse located in a densely populated neighbourhood of León. While this Compendium classifies On-site Treatment Systems in the Functional Group S, this treatment system, based on its complexity, is classified as Semi-centralised Treatment (Functional Group T). Organic Waste from animal husbandry, slaughterhouses or food processing industries often are located within the urban environment, leading to overload of existing sewer networks and polluting air and water bodies in the vicinity. This situation can be found in many urban agglomerations across the Wider Caribbean Region. Because the Treatment Technologies presented in Part 2 can treat and transform the various waste streams into reusable products, this case study was selected to be shared in this Compendium.

Until 2015, wastewater from the León municipal slaughterhouse was discharged daily without any treatment into the city's sewer network. The sewer system and especially the pumping stations presented constant obstruction problems due to the high organic loads and

the remains of bones, blood, fat, hair, etc., from the municipal slaughterhouse. The organic waste generated at the slaughterhouse was not considered of value and 1.5 tons per day of manure from the rumen (intestines) of the cattle were transported to the municipal landfill of the city of León.

Planning process Due to the problems presented at the slaughterhouse, regarding the mismanagement of solid and liquid waste, the municipality sought a solution to avoid the contamination of the Chiquito River and in general the contamination caused by bad odours in the surroundings, which affect the health and well-being of the residents in the vicinity.

First, a mapping of relevant stakeholders was carried out to start the formulation activities and carry out the project. A project team was created with the participation of the following representatives from the relevant parties: International Cooperation, Municipal divisions, such as Project and Environmental Management and Municipal Services, the Hamburg Twinning and BORDA. Once the problem was identified, the project team defined a strat-

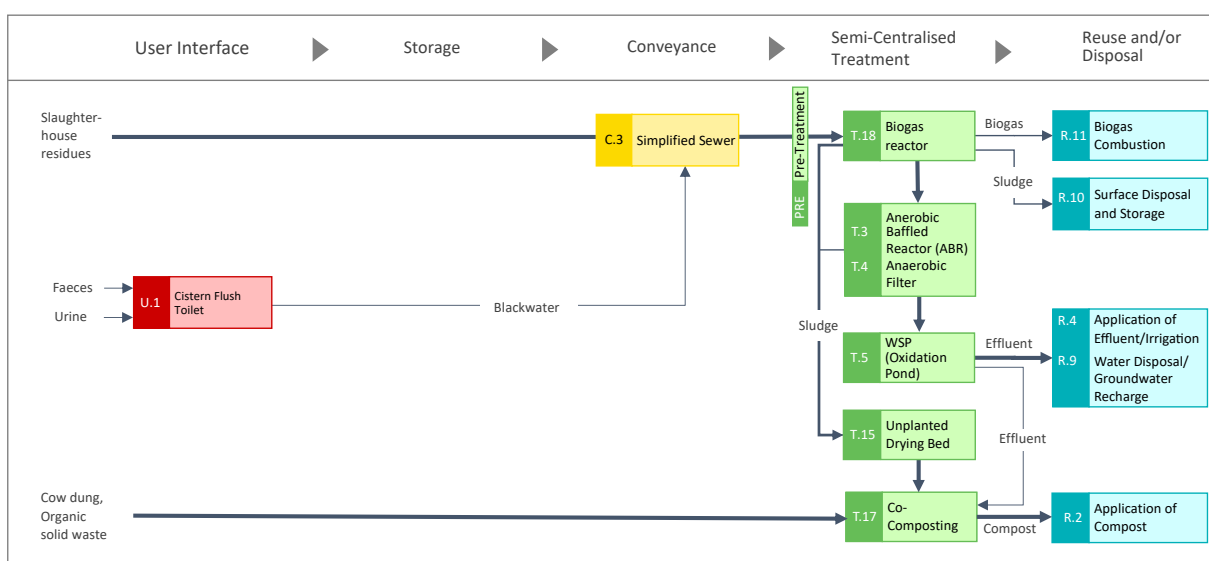

Figure 1: System diagram

egy and a specific action plan to achieve the proposed objectives. Human, financial and material resources were assigned based on the planned activities and a working agreement was established. The project team held weekly follow-up meetings to keep track of the activities, the progress and the budget in order to have a successful project.

The vision, objectives, risks assessment and brainstorming sessions were all carried out in a participatory manner with the contribution of all stakeholders.

A Technical Project Committee met regularly to review the project budget and the execution of works assigned to ERAMAC (a municipal company responsible for implementing the Hamburg Twinning agreement). Engineering design was developed by BORDA and presented to ERAMAC for its implementation. The Technical Committee met every 15 days, or whenever necessary, during the project implementation period to evaluate the project status from the financial and technical perspectives. Finally, operators were trained on operations & maintenance of the infrastructure to ensure the project's sustainability.

Technical aspects The wastewater treatment approach was developed and, in addition to the original purpose of reducing environmental pollution, it incorporated the “water-energy-food security” nexus approach to achieve a holistic perspective that deviates from the traditional vision of the subsector. This is reflected in the use of the treated wastewater in the organic orchard and the heating of water with the biogas generated as a by-product of the anaerobic and biological treatment of the wastewater.

A series of modules were implemented to create an effective, efficient and affordable decentralised wastewater treatment solution (DEWATS). The technological choice is based on the principle of easy maintenance and negligible power consumption. Figure 1 shows how the system was configured.

DEWATS facilities are designed and sized in such a way that the treated water meets the parameters stipulated by environmental laws and regulations. The treatment process is based on four steps:

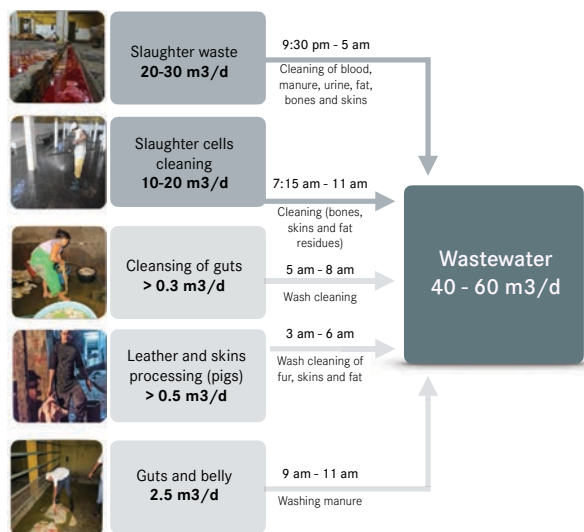

Figure 2: Quality and quantity of wastewater production. Blood is the highest pollutant. COD up to 375 000 mg/L. Livestock manure is the 2nd highest pollutant contributing to TDS and COD.

Biogas reactor (T.18): This stage involves sedimentation and flotation since the separation of solids is a crucial step for the efficiency of the system as a whole. This initial stage of the process aims to achieve the highest separation of settleable solids and floating solids.

Anaerobic baffled reactor (T.3): The effluent is forced to circulate through various chambers, which are isolated from each other and communicated only by pipes that direct the fluid, from the top of one chamber to the bottom of the next. As the fluid moves along the anaerobic filter, it comes into contact with the active sludge (rich in microorganisms) present at the bottom of each chamber, which facilitates the digestion of the organic matter present in the water.

Anaerobic filter (T.4): This stage consists of independent chambers, containing volcanic rocks on a concrete grid, which works as an anaerobic filter. The irregular body and porosity of volcanic rocks facilitate the proliferation of bacteria communities. As the effluent circulates from one treatment chamber to the other, it is forced to pass through this rock filter. Each chamber facilitates the sedimentation of solids still present in water.

Oxidation pond (T.5): The last stage of the process is carried out aerobically in oxidation ponds, which facilitate further reduction of the organic load (measured as concentrations of biological and chemical oxygen



Figure 3: Service access to floating drum biogas reactor (T.18)

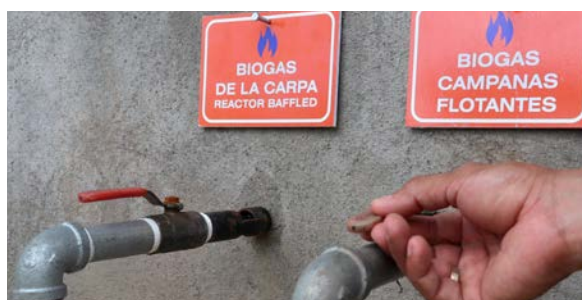

Figure 4: Biogas outlet from ABR (left) and Biogas reactor (right)



Figure 5: Anaerobic baffled reactor (T.3) with membrane cover

demand). Three biogas reactors, an anaerobic reactor and an oxidation pond were constructed, according to the detail presented in Table 1.

Tab. 1: Component sizing

Component	Size	Hydraulic retention time [days]
Biogas reactor for pigs	21 m ²	02
Biogas reactor for intestines	19 m ²	10
Biogas reactor for cattle	30 m ²	0,6
Anaerobic baffled reactor and filter (ABR+AF)	120 m ²	2-3

The treated wastewater is re-used, using a solar pumping system and drip irrigation in the organic garden at the slaughterhouse. Approximately 1 500 - 2 000 m³/year of treated wastewater is used in the agricultural production area at the slaughterhouse and composting process. In 2021, a total of 20 670 kg of organic fertiliser were sold. The biosolids come from the slaughterhouse processes and from the animal pens.

Up to 16 000 m³/year of treated wastewater per year comply with the maximum permissible limits for disposal in the sewer. Laboratory analyses comply with Art. 30 on the quality parameters for liquids to be discharged into sewer networks, as shown in Table 2.

Tab. 2: Water quality monitoring parameters

Parameter	Concentrations at effluent [mg/l]	Discharge standard [mg/l]
COD	144 - 620	900
BOD	100 - 240	400
SS	30 - 220	400

Between 7 m³ and 9 m³ of biogas are captured and burned every day (approximately 2500 m³/year). This is equivalent to the calorific power of 12500 kg of firewood, which was previously used every year to heat

water at the slaughterhouse. This implies a 2000 kg CO₂ reduction from the original process.

Institutional and normative aspects According to the Law of the Environment and Natural Resources (No. 217), it is the responsibility of the Ministry of the Environment and Natural Resources (MARENA) to establish the standards for the conservation, protection, improvement and restoration of the environment and natural resources, so as to ensure its rational and sustainable use. Currently, the Ministry of Health (MINSa) has the competency to monitor and regulate wastewater discharge from domestic, industrial and commercial activities to the limits established by Law No. 217 and related by laws. Wastewater generated during the slaughter process of cattle and pigs is classified as an industrial effluent and reduction of the organic load is needed before discharging the effluent to the sanitary sewer.

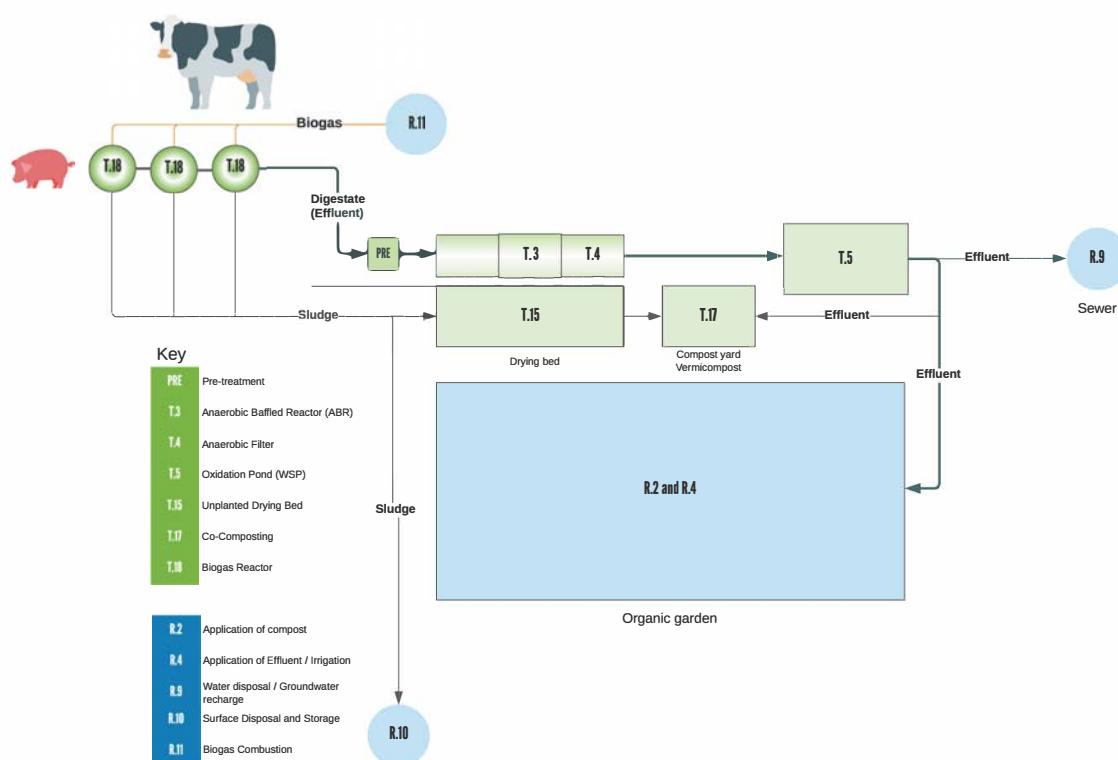

Figure 6: System layout

Tab. 3: Summary of project activities

Component	Items
Infrastructure improvement	<ul style="list-style-type: none"> • Construction of an area for washing in slaughter process for cows • Replacement of electrical system • Design and construction of drainage system for rainwater and water from pig washing • Construction of roof for the pigsty area • Rehabilitation of existing well • Construction of a biogas or wood crematory for discarded animals • Assessment of improvements for the slaughtering process
Management improvement	<ul style="list-style-type: none"> • Organisational study • Infrastructure assessment
Personnel training	<ul style="list-style-type: none"> • Training and capacity development on operation and maintenance of the wastewater treatment system • Training on reuse of by products
Communications	<ul style="list-style-type: none"> • Series of workshops with the slaughterhouse customers
New equipment	<ul style="list-style-type: none"> • Centrifugal pump with all fittings for maintenance of biodigester • Industrial heater which uses biogas for heating water for rumen processing. • Instruments for measuring CO₂, H₂S, CH₄ and gas consumption • Personal Protection Equipment • Industrial hoses • Bone crusher • Static sieve for rumen

Financial aspects Total investment cost was approximately \$178 300, including the activities presented in Table 3. Direct Operation & Maintenance Costs (does not include labour costs) total \$215/ year. See the details of OPEX costs in Table 4.

Tab. 4: Operation and maintenance costs

Activity	Annual OPEX [USD]
Rakes, shovels, boots, gloves and masks	85
Fuel and operation costs for vacuum truck	115
Fuel for centrifugal pump	18
Total	215

Success/failure factors and lessons learned

About 10 to 30% of the treated water is being used in drip irrigation for vegetable production in the organic garden and composting area. Compost made on-site is currently being sold.

The capture of biogas has improved the conditions for workers and the environment and is used for heating water instead of firewood, which produces gases and particles that affect human health.

The slaughterhouse complies with national regulations for the discharge of wastewater. Thanks to dissemination to NGOs, academics and other visitors, the project has become a national reference for other slaughterhouses. The project has not achieved full sustainability yet, due to lack of resources and some administrative problems between the slaughterhouse and the community. More effective involvement and greater cooperation from the Municipality would be instrumental in solving current problems and to reach long-term sustainability.

References & Further Reading

can be found on page 263



Figure 7: Different Compost and vermicompost qualities from co-composting pure (not cross-contaminated) organic substrate (T.15, T.17 and plant residues).

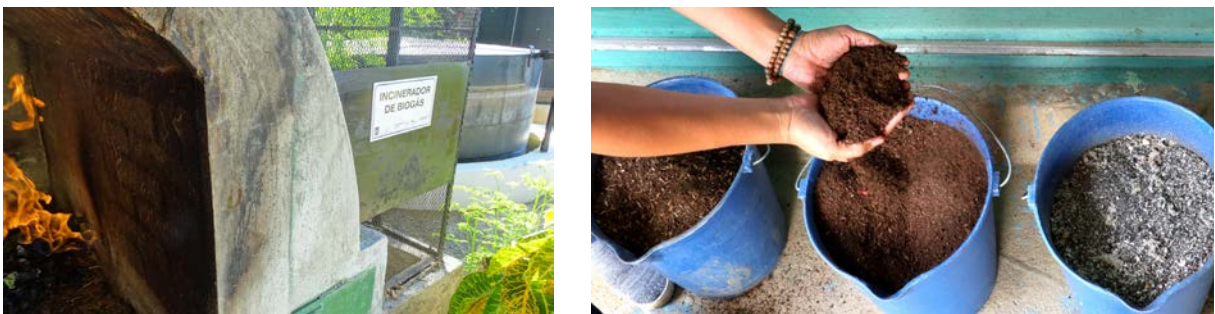

Figure 8: Compost may be enriched, e.g. by bonemeal or horn shavings. Twenty tonnes of organic fertiliser was sold in 2021.



Figure 9: A solar pumping system (see Figure 7, top left image) is supplying 2 000 m³/y treated wastewater through a drip irrigation system for organic vegetable production with 34 seedbeds (1.2 m x 26 m each).

Case 3: Semi-Centralised Wastewater Treatment for New Housing Developments in Nindiri, Nicaragua



General aspects In 2012, the Monte Cielo condominium, a new housing development located in the Municipality of Nindiri, Masaya (Nicaragua), completed the implementation of a sanitation system for 5 040 people. The design and implementation of the treatment plant was carried out by BIOSAM (Biosistemas integrados para el saneamiento ambiental S.A.), a company based in Nicaragua dedicated to wastewater and environmental management.

Planning aspects The developer decided to implement a conventional sewer system to collect domestic wastewater from 847 households and convey it to a Semi-Centralised treatment plant, which was exclusively designed to meet the needs of the condominium. Figure 1 shows the basic data of this sanitation solution. According to the General Law of Environment, the ministerial decree of environmental permits 20-2017 and decree 21-2017 of wastewater discharge, at the time of applying for construction permits, new urban developments must include water and sanitation services and wastewater treatment systems. This is the case of the surroundings of the Municipality of Nindiri,

which has experienced an intense urbanisation process since 2005. Developers have the freedom to choose the treatment technology based on the technical options available in the market, as long as the effluent complies with local regulations. In Nicaragua, most developers prefer anaerobic systems due to lower energy costs. The Nicaraguan Technical Standard 05-027-05 “Environmental Technical Standard for wastewater treatment and reuse systems” establishes the technical provisions and regulations for the location, operation, maintenance, management and disposal of effluent and solid waste generated by domestic wastewater treatment systems, including water reuse.

Technical aspects Table 1 presents the initial data for the dimensioning of the treatment plant.

Tab. 1: Project data for engineering design

Population [inhabitants]	5 040
Daily allowance [lpcd]	120
Daily average flow [l/s]	7
Minimum flow [l/s]	3.5
Maximum flow [l/s]	22.7

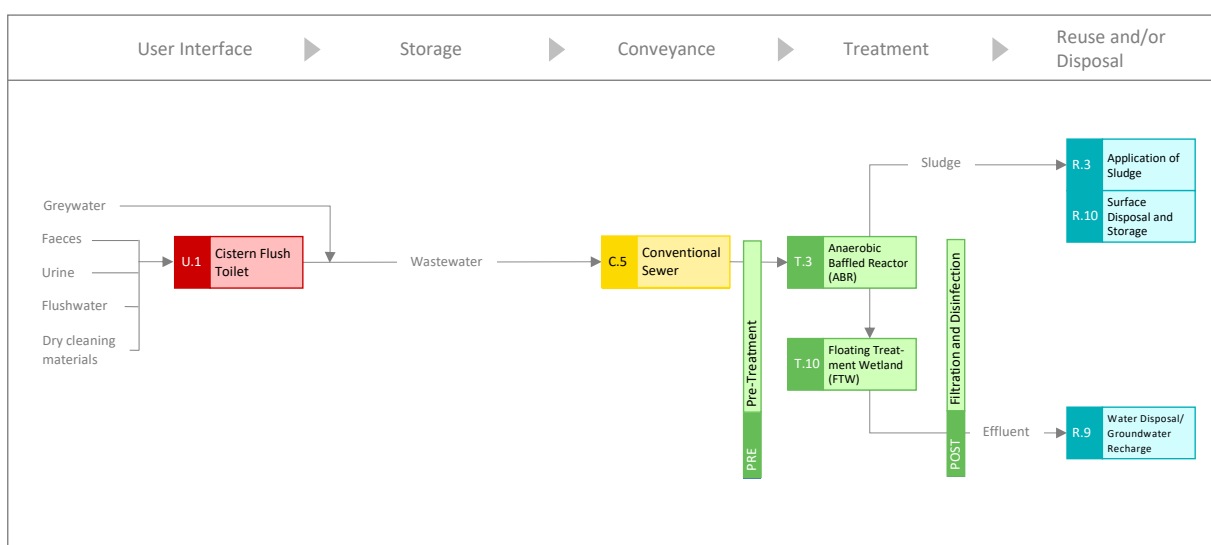

Figure 1: System diagram

The treatment train implemented in this project includes preliminary treatment, which prevents the passage of solids that could obstruct the plant, such as solid waste, plastic bags, gravel and sand. The pumping well temporarily stores wastewater and from this point it is pumped into the distributor tank.

Distribution tank: Wastewater is pumped to the distribution tank and then distributed to the anaerobic reactors.

Upflow anaerobic reactors: The purpose of this circular fixed dome ABR is to digest and reduce organic matter present in water, mainly turning it into carbon dioxide and methane. BOD removal efficiency ranges between 60% and 80%. Sludge is retained in the reactors for at least one hundred days creating an active biomass apt for treatment. It is necessary to periodically remove the

old sludge. Since this sludge has been digested, it can be directly dried or composted after removal.

Floating treatment wetland: Acts as a third step in the treatment system to reduce the concentrations of settleable solids, pathogens and nutrients by naturally floating macrophytes (hyacinths). This form of treatment differs slightly from the floating treatment wetland (T.10) and bears characteristics of a floating plant pond (R.8).

Outlet works: This transports the final effluent (treated wastewater) to a canal where it is discharged.

Treatment efficiency:

Table 2 shows the removal of organic matter in the treatment plant measured as the reduction of BOD₅ concentration in water.

Tab. 2: Water quality monitoring and treatment efficiency

Parameter	Inlet	After anaerobic treatment	At outlet of plant (effluent)	Limit according to standard	Removal efficiency
BOD ₅ [mg/l]	400	80	24	80	94%

Financial aspects The total investment cost for this treatment was \$250 000 or \$295.00/household. Operation and maintenance costs are estimated at 0.11 – \$0.15/m³.

Success factors and lessons learned The treatment system turned out to be a cost-effective solution that complies with local standards and does not require highly specialised staff. The whole system was constructed in only four months.

This type of solution can be developed modularly, so additional modules can be added as demand grows (incremental investment). In this case, in two years, the demand reached 80% of the nominal capacity of the plant.

The implementation of this system showcased all the benefits of a cost-efficient treatment system to other developers.

References & Further Reading

can be found on page 263

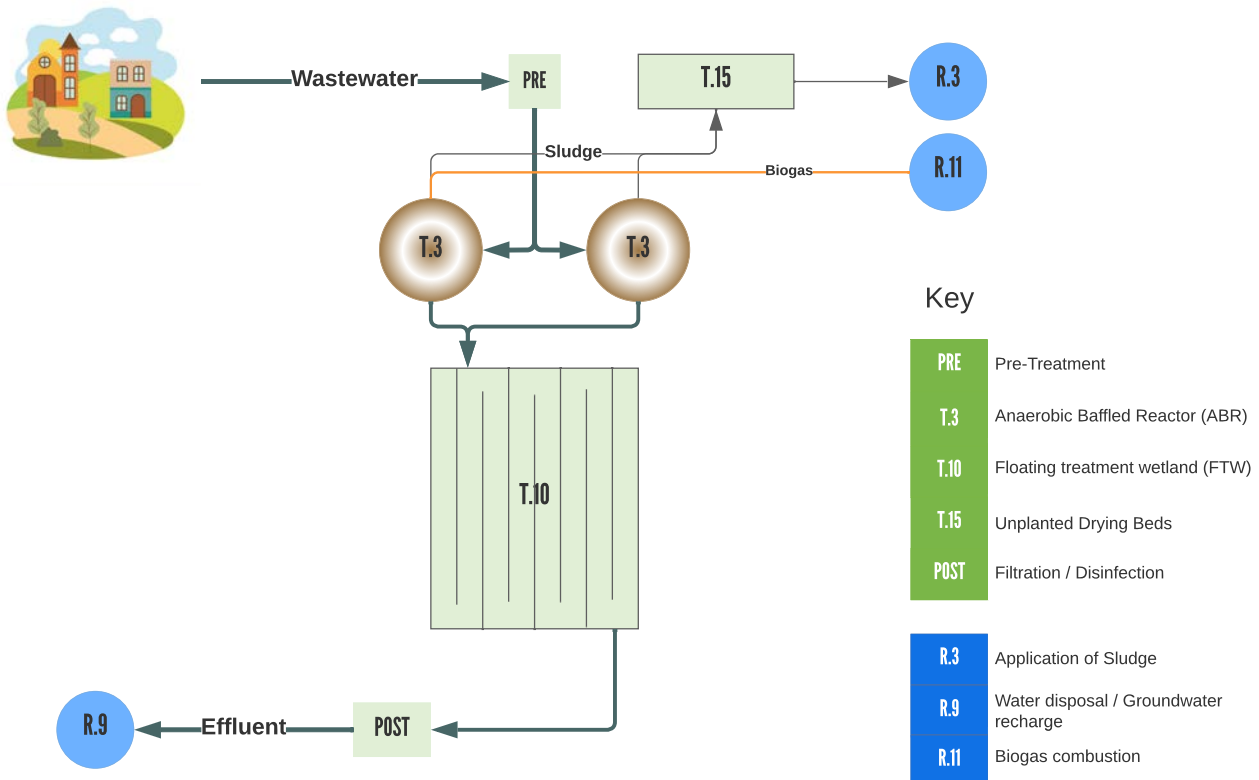

Figure 2: System layout



Figure 3: Additional perspectives on the Nature-Based Solution for wastewater treatment of the new housing developments in Nicaragua.



Figure 4: Using prefabricated fiber-reinforced plastic or monolithic concrete (around 500 people for this office building in Miramar) the installation time can be reduced to 3 days.

Case 4: Wastewater Treatment and Reuse for Golf Course Irrigation in a Large Beach Resort in Punta Cana, Dominican Republic



General aspects Punta Cana (Dominican Republic) is the main tourist destination in the Caribbean with over 40 resorts and hotels located on the seashore. Their size varies from 300 to 2000 rooms and the water consumption of one complex is close to that of a small town of 10 000 to 20 000 inhabitants. PROAMSA, a group of companies, which provides services in the area of wastewater treatment, including design, construction, operation and maintenance, was hired in 2012 to refurbish the treatment plant of a large resort that was not working properly.

Planning aspects The engineering team decided to perform a detailed evaluation of all the components of the existing plant to determine the main problems and to identify improvement measures. Figure 1 shows the company's approach to solve the problem. During the evaluation of the existing system, the following problems were identified:

- There was no historical data about operation and control parameters
- Screens at the inlet works were not working
- Flow was not evenly distributed among the components
- Gas and liquid phases were not properly separated within the anaerobic reactors
- High concentration of algae in the effluent
- Low global treatment efficiency (only 45% reduction of organic matter)

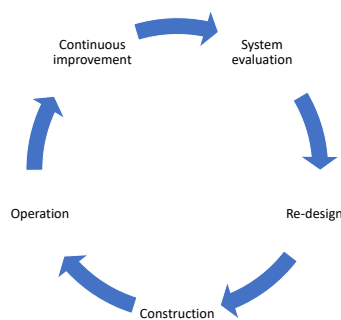

Figure 1: Project cycle for the evaluation and improvement of an existing wastewater treatment system

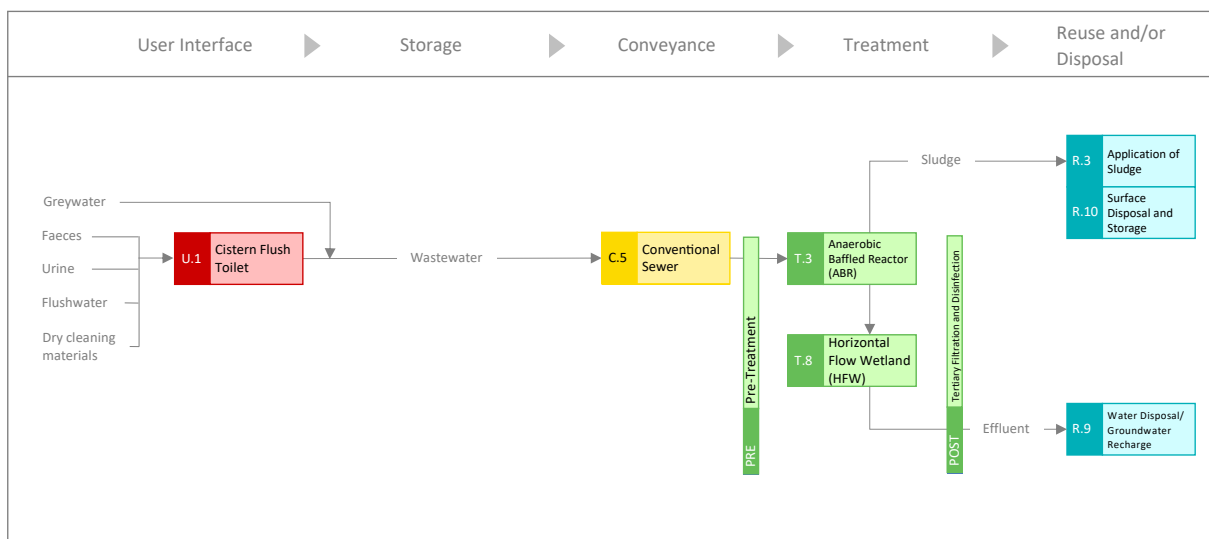

Figure 2: Sanitation system for collection, treatment and reuse of wastewater generated in a beach resort

Technical aspects The treatment system consists of the following components:

Collection network (C.5): This includes all the pipes and pumping stations to collect and transport blackwater from all sanitation services (bathrooms including flush cistern toilets, showers and sinks) of the resort as well as from all the restaurants in the complex.

Preliminary treatment (PRE): Fixed screens installed at the inlet works of the plant that separates water from large solids that might have been collected in the sewer network.

UASB Reactors (T.12): Four Upflow Anaerobic Sludge Blanket Reactors in parallel, which digest organic matter present in wastewater.

Stabilisation ponds (T.5): Two facultative ponds and two clarification ponds.

Chlorination unit (POST): It is part of the post-treatment. The chlorination unit injects chlorine gas into the effluent for pathogen reduction.

Golf course irrigation (R.4): This is the irrigation system for a golf course in the same resort. The treated effluent is directed to lakes located in the golf course and then pumped for irrigation, using a sprinkler system.

Figure 3 shows the layout and the main components of the sanitation system at the resort.

The sanitation system for the resort collects, conveys, treats and reuses a total flow of 4 000 m³ of water per day. The wastewater is basically from domestic activities that take place in the residences (hotel rooms) and restaurants of the complex. Based on water samples, it was determined that the following concentrations of organic matter in the suspended solids were: BOD₅ = 399 mg/l and TSS = 200 mg/l.

After evaluating all of the components, it was decided to perform the following improvements to the system:

- All screens were repaired and adjusted, according to the local conditions
- UASB reactors were modified to insure proper hydraulic retention times, good phase separation (liquid/gas) and even flow distribution among them
- The flow in the stabilisation ponds was improved to avoid dead zones (areas with stagnated water)
- The filtration system (post treatment) was rehabilitated and the chlorine gas disinfection system was replaced by a new one that uses chlorine in liquid form.

Additionally, the algae count was significantly reduced once the treatment plant was operating in its new condition (See Table 2) and the water lakes in the golf course where the treated effluent is discharged improved visibly, changing from green colour due the excess of algae to blue (See Figure 5).

Success factors and lessons learned The efficiency of the UASB reactors at the initial evaluation of the system was as follows: BOD₅ 18% - 45%, COD 12% - 45% and TSS 25% - 45%. After all the improvements were implemented, the efficiency rose to BOD₅ 67%, COD

65% and TSS 70%. These efficiencies are congruent with typical efficiency ranges reported in the literature for UASB reactors of 65% - 75%.

There are thousands of wastewater treatment plants that have been built in the last 20-50 years in Latin America and the Caribbean that are not operational. This case demonstrates that old infrastructure can be refurbished, updated or improved to provide efficient treatment.

References & Further Reading

can be found on page 263

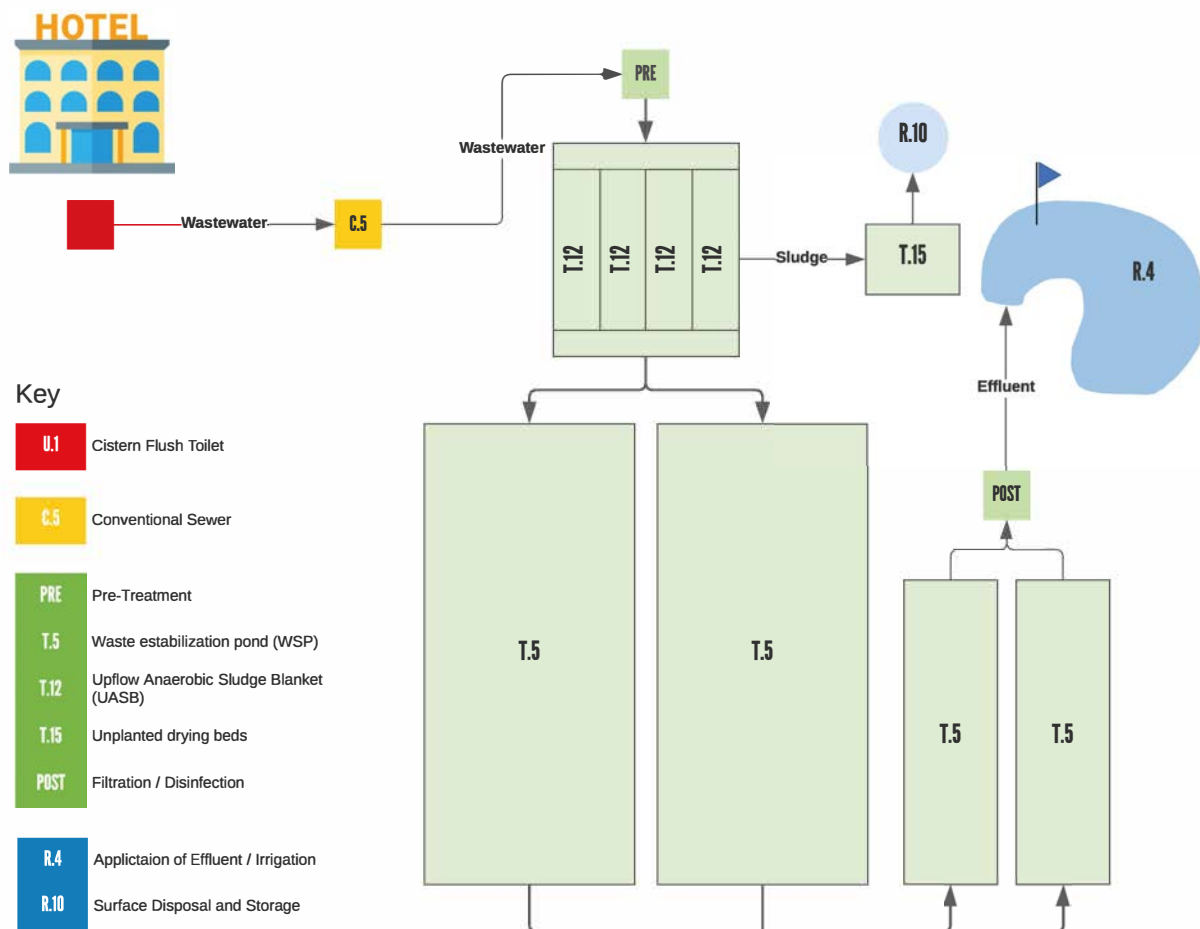

Figure 3: Layout and main components of the wastewater treatment system at the resort

Table 1 presents characteristics of waste water before and after treatment and highlights the positive impact of the retrofitting and improvements in the system performance of the 4 UASB of the treatment plant.

Tab. 1: Summary of monitoring parameters before and after the improvements

Parameter	Avg. value before improvements	Avg. value after improvements	Limit according to local standards
BOD ₅ [mg/l]	56	26	35
COD [mg/l]	202	96	130
TSS [mg/l]	170	43	40

Tab. 2: Algae count in lakes before and after the improvements

Algae type	Algae count before improvements	Algae count after improvements
Chlamydomonas sp.	8 1680,000	30 000
Spirulina sp.	20 000	0
Euglena sp.	10 000	0
Chorella sp.	80 000	7 500

Figure 4 shows some of the construction works and retrofitting that took place to improve the performance of the 4 UASB of the treatment plant.



Figure 4: Improvements in UASB reactors for higher treatment efficiency



Figure 5: Improvement in the quality of water in the lakes

Case 5: Water Savings and Sustainable Sanitation with Container-Based Sanitation for a Periurban Community at Lake Atitlan, Guatemala



General aspects Guatemala, the most populous country in Central America with 17 million inhabitants, is among the countries with the worst access to sanitation in Latin America. Estimates indicate that 35% or 6 million people do not have access to a basic sanitation service; this increases to 49% in rural areas.

Challenges to conventional sanitation systems in low income, densely populated communities in Guatemala include factors such as the cost and technical complexity of sewer systems and wastewater treatment plants (WWTPs), the difficulty of safe containment, the emptying and disposal of waste in onsite-sanitation systems (OSSs), the lack of investment around sanitation, and current and projected water shortages in certain areas. Adaptable, off-grid, market-based sanitation solutions can contribute to bridging this gap by addressing the most vulnerable communities. Mosan is an international social enterprise, offering circular off-grid dry sanitation services for densely populated settlements. It currently operates in the department of Solola in the Lake Atitlan region, where about 250 000 people live in 18 municipalities, of which more than 95% are indigenous and belong to different Mayan ethnic groups. Some important problems for the communities

are water pollution, due to improper waste disposal, indiscriminate use of agrochemicals in the soil and untreated or inefficiently treated wastewater. With a poverty rate of 81% and an extreme poverty rate of 40%, providing affordable improved sanitation in the region remains a challenge. Of the 71 438 households in the lake basin, 24% are connected to the sewerage system, 20% have a septic tank while the remaining nearly 40 000 families have latrines or nothing at all. Emptying septic tanks and latrines is challenging due to the terrain, narrowness, and steepness of the alleys, which prevents access to vacuum trucks that are also not common in the region. Only 21% of the wastewater generated in the region is treated in the few operational WWTPs. This leads to the eutrophication of the lake water and a high level of faecal coliforms, resulting in numerous cases of illnesses transmitted via water or food, affecting over 30% of children. Moreover, only 1 out of 12 plants is confirmed to comply with all the regulations; the rest release effluents with a high chemical and biochemical oxygen demand. The inefficiency of WWTPs is caused by inadequate design, lack of knowledge of operating and maintaining the plants, elevated costs and a lack of control over wastewater effluents.

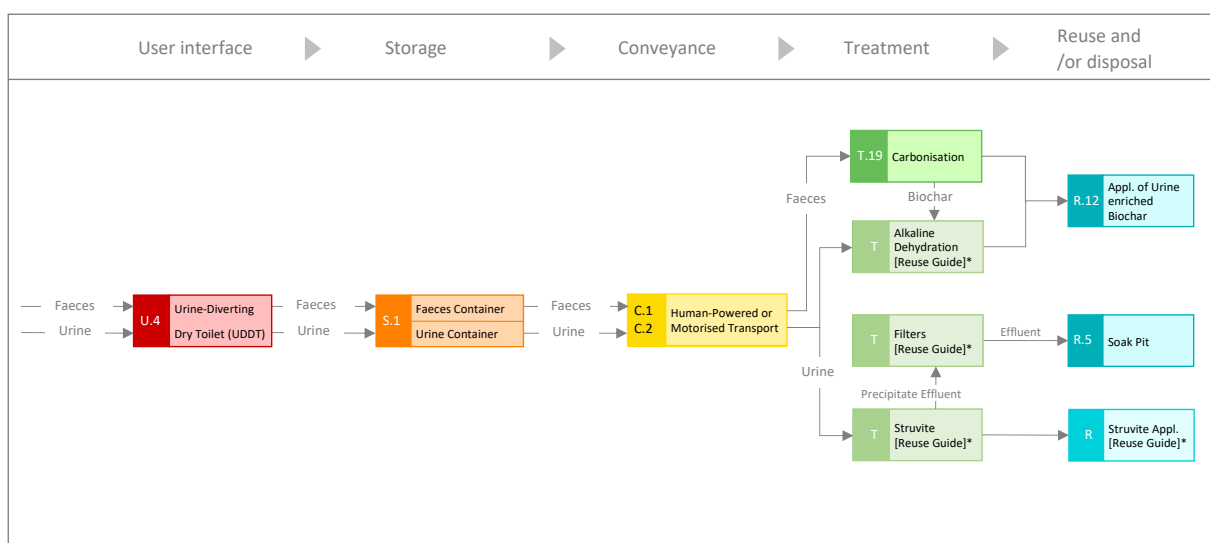

Figure 1: System diagram

Planning aspects Mosan has implemented a decentralised, circular sanitation solution, encompassing the entire sanitation chain which includes user interface, containment, collection, transport, treatment and reuse. Focused on community-scale systems, Mosan is applying participatory design principles and co-creation to enable community engagement, raise awareness, trigger the creativity of the population and support local innovation. Inadequate sanitation is addressed by providing an ecological, circular sanitation system. The solution includes a urine-diverting dry toilet appropriate for densely populated settlements or for areas where conventional sewerage systems are not feasible, due to either difficult terrain, hard ground, lack of water or investment capacity. Mosan ensures safe collection, containment, transport and transformation of human excreta. The excreta is then valorised into products that can be commercialised. The illustration of this circular approach is depicted in Figure 2.

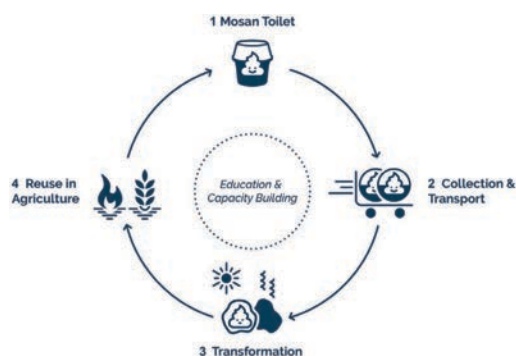

Figure 2: Mosan circular approach to sanitation

This concept grew from the vision of giving people a safe and affordable sanitation service that is easy to use and install. The Mosan solution is designed to integrate high-quality standards. The goal is to provide a dignified and attractive sanitation solution that is perceived as modern and that is not associated with old-fashioned dry alternatives, such as pit latrines. The system is designed for resilience, safety, adaptability, fast deployment and replicability. The aim of this system is to provide immediate emergency response in case of extreme weather events or other climate related, political or social hazards, as well as a permanent sanitation solution for densely populated, low-income, vulnerable settlements where conventional sewage systems fail.

Technical aspects The toilet designed by Mosan is an ergonomic mobile, and light-weight in-home toilet. The toilet is in its fourth iteration and is the result of a participatory design process that included users and stakeholders in Bangladesh, Kenya and Guatemala. Industry collaborations allows for optimisation and large-scale production, easy shipping, stacking and transport. The toilet is made from recyclable polyethylene. The first models were produced in 2013 and are still functional, thus allowing for an estimated minimum lifespan of 8 years. The materials are fully recyclable. The Mosan Toilet includes two sealable containers: one for faeces, in which sawdust or wood chips are used for covering to prevent odours and flies, and one for urine, that has an odour seal, which closes after use. The separation of urine and faeces is key to prevent smells and ensure

the efficient transport, transformation and reutilisation of excreta. Two times per week, users bring their full containers to a collection point where fresh containers are provided by Mosan’s service staff. Containers are emptied and cleaned, and excreta are then transferred into bigger barrels, which are transported to the transformation centre. The transport is currently done by foot, but a motorised transport or a combination of both is possible for areas with road access. Mosan’s service is illustrated in Figure 3.



Figure 3: Service activities

At the transformation centre, the faeces mixed with sawdust are carbonised into biochar. Carbonisation is explained in the technology information sheet R.12 (p.114).

Biochar can improve soil properties and it has also been recognised by the Intergovernmental Panel on Climate Change (IPCC) as a viable and scalable carbon sequestration measure. Multiple studies have shown the potential of biochar to improve soil health. Increases in cation exchange and water-holding capacity and enhanced nutrient uptake, microbial activity and fertiliser performance have been observed with the use of biochar in soil. The effects on the soil have direct impacts on agricultural productivity. A study in Nepal demonstrated an increase of over 100% in crop yield when cow urine-enriched biochar was used as fertiliser. Enriched biochar (e.g. with urine, compost, digestate and dissolved mineral fertiliser) shows promising

results given its nutrient-carrier effect that ensures slow release, reduced losses and more balanced nutrient fluxes. All these features make biochar, applied alone or enriched, attractive for use in agriculture.

The urine is currently collected and precipitated with magnesium oxide into struvite, a phosphate mineral. While this process was chosen mainly because it is simple to develop, struvite is not a complete fertiliser as it contains low values of nitrogen and no potassium.

Through its operation, the system has the potential to contribute to climate change mitigation through the prevention of methane emissions by safely containing excreta. To quantify the climate impact of container-based sanitation (CBS), the Container Based Sanitation Alliance (CBSA) supported by the Water Supply and Sanitation Collaborative Council (WSSCC) have done a study based on four CBS operations. The results indicated that the CBS systems save 80–210 kg CO₂ eq/ person/ year. The savings were calculated against existing onsite sanitation systems, such as pit latrines and septic tanks. High population growth and the extended use of on-site solutions in periurban areas may lead to increases in methane emissions that may undermine climate change mitigation efforts. In addition, methane has greenhouse warming potential which is 80 times higher than that of CO₂ for a 20-year timeframe (GWP₂₀); thus, it has an important impact on climate change particularly in the near term. The latest IPCC report (Sixth Assessment Report) highlights that climate resilient development prospects are increasingly limited if current greenhouse gas emissions do not rapidly decline.

The other climate change mitigation potential lies in the use of biochar in the soil as a CO₂ sequestration measure. Biochar is primarily made up of stable organic carbon, which, when applied to soil, can be locked up for several centuries. When anaerobic conditions are present, which is most of the time for onsite sanitation systems, organic matter decomposition leads to methane emissions. By using carbonisation and applying biochar to soil, up to 50% of the carbon that would otherwise be released as methane can be locked in, while the rest will be released using the biofuel

created. A visual representation of the carbon cycle with and without carbonisation can be seen in Figure 5. In addition to storing carbon, biochar has been shown to improve the soil quality and, if enriched, can potentially be a replacement for synthetic fertilisers, which would lead to additional CO₂ savings.

The environmental impact of biochar goes beyond its climate change mitigation potential into reducing water usage and effectively limiting excreta contamination in people's houses, water bodies and community environments. Creating systems that have a regenerative effect on the ecosystem is a core part of the operation. A strong focus is put on education, awareness raising and local capacity building, which are crucial elements in ensuring the solution's adoption and sustainability in the long term.

Institutional and regulatory aspects Mosan's model is centred around several actors and markets:

(i) The market of "sanitation as a service" is offered to an offtaker; these could be municipalities, NGOs or other institutions financially supporting local communities.

This is a rather new approach and certainly not common in the local context. Access to sanitation is most commonly either the responsibility of individual households or of the municipalities in charge of building centralised systems.

(ii) The market of "sanitation as a service" is based on a subscription model to end users. In the Mosan case, users are households that use the service, for which they pay a monthly fee. In Mosan's current service location in the village of Santa Catarina Palopo in Guatemala, the monthly fee is set at about \$5, which is 1.3% of the average household income, assuming that one adult in the household is earning the annual gross national income. This is well below the 3–5% affordability benchmark for water, sanitation and hygiene defined by the World Bank. The fee is meant to ensure the engagement and commitment of the users and to increase the perceived value of the service at an affordable price. By joining Mosan, users receive the Mosan Toilet, benefit from a container exchange at collection points and are regularly invited to educational events and capacity-building workshops.

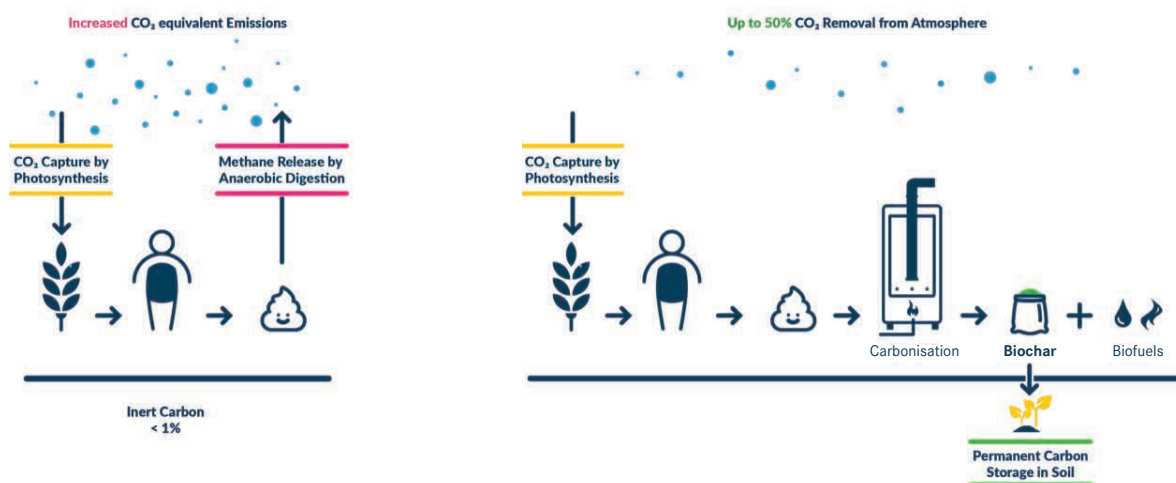

Figure 4: CO₂ capture process. Carbon cycle with anaerobic digestion (left) and with carbonisation (right).

(iii) The market of commercialising agricultural products, such as biochar as a human excreta-derived soil amendment, creates commercialisation of biochar as a revenue stream that can progressively become more significant and cross-subsidise parts of the sanitation service's operational costs.

(iv) The carbon market is affected as given its positive climate impact, Mosan can sell carbon credits on the voluntary carbon market. This can become a considerable revenue stream once a certain scale is achieved.

Mosan is developing its service based on a design-build-operate model via which ownership, management and O&M remain with the company. The offtaker would contract Mosan to implement and operate a sanitation service in a given community. Although in the future, it is possible that no offtaker obligation is needed to make the service financially viable, it is very beneficial to establish some sort of government support and recognition as an enabling local environment to support innovation.

Through involving numerous local actors, community leaders, users, and prospects, Mosan facilitates participation, following a multi-sector, multi-actor approach. Building a wide range of skills and local capacities is critical for Mosan to be a sanitation service facilitator, whose role is guiding and supporting a service led and operated by community representatives. Developing inclusive implementation strategies is important to ensure the adaptability and sustainability of the system. Stakeholder participation throughout the design process creates shared ownership, buy-in and responsibility and supports the co-creation of locally and culturally feasible solutions. The goal is to go a step further and cultivate leadership from the community in managing, maintaining and growing the service after the design process. The community-led sanitation services are built through the participatory approach and by providing agency to the community to have decision-making power and leadership in the long-term.

Mosan's strategy is to scale via social franchising, seeking to enable community-led services, thus, maximising its social and environmental impact. The replication via franchising would allow Mosan to share responsibilities with the franchisee, who would learn how to operate the sanitation service on a daily basis, while Mosan can focus on development and innovation. Mosan would provide a start-up package, training and support in setting up the service. Franchisees would go through intensive training and remain in close relationship with Mosan.

Financial aspects The above-mentioned revenues cover the operational costs of the service, while the capital investment is covered by investors, donors and reinvested profits. Given the modularity, small-scale and use of optimised, low-cost technologies, capital costs are kept low. Direct operating costs are largely dominated by labour costs. This means that scaling the model would translate in job creation in low-income communities and increased economic activity. This also means that direct operating costs can be optimised with scale and the professionalisation of the operation. For services over 1000 units, the cost per year would amount to \$300, which is between 30% to just over 60% of the average costs of a sewerage system, depending on the type of system. Fertilizer sales and the activation of alternative revenue streams, such as carbon credit sales, would certainly increase the resilience of the operation to risks associated with contracts with sanitation service offtakers. 100% operational cost recovery could be achieved commercially, if the maximum possible revenue from these two sources is assumed. However, in the short term, there will most likely be a gap that needs to be secured through public contracts or subsidies.

Success/failure factors and lessons learned

It is widely recognised that sanitation services need government support, direction and legislative integration. However, relying too much on them would make the business move very slow or even stagnate. While short term financial sustainability will most likely rely in the short term on a mix of earned revenues and

public financing or other investments, it is important to plan for the long term to reach sustainability through commercial revenues. Until then, sustaining these kinds of innovations and their diffusion would certainly require a combination of efforts by multiple sector stakeholders, cooperation, advocacy, and most importantly, adequate, impact-linked financing.

The stigma of poverty, topped with the tabu of sanitation, makes the 'toilet' conversation a difficult one to have in an indigenous community. Most do not want to reveal that sanitation may be a problem in their household. Mosan did a demand assessment in Santa Catarina Palopo in 2019 where 230 households were interviewed. The interviewers were chosen from people in the village, current users, so that the interviewees would feel at ease. Nevertheless, only 4 out of the 230 households interviewed reported to have a pit latrine as their current sanitation solution. However, based on

official sources, over 60% of the community currently have pit latrines. Almost all of the families said that they use sewer connected or septic tank connected flush toilets. When everybody wants water flush toilets, any other solution might look like a step back. Mosan invested a lot of effort into the design and image to make the toilet look attractive, trendy, aspirational and not a compromise. Nothing is more telling about a product than its early adopters. The early adopters in the community shape the way the solution is seen so it is important to start involving people from the beginning who are representative of the target market. Plus, clients make the best ambassadors. At Mosan, clients are key in the co-creation processes, marketing and community engagement events.

References & Further Reading

can be found on page 264



Case 6: Wastewater Treatment and Reuse for Crop Irrigation at Municipal Level in Tolata, Bolivia



General aspects The urbanisation process of cities in Bolivia and the increase in the coverage of sanitation services in recent years have generated a considerable increase in the demand for drinking water and, consequently, have generated more wastewater. This is the case of the Municipality of Tolata (5 000 inhabitants) in the Department of Cochabamba, which in 2015 provided piped and sewerage services to households, but did not treat its wastewater and, therefore, negatively affected the water bodies surrounding the urban centre. To address this challenge, the Municipal Government of Tolata managed a cooperation project with the Swedish Embassy in Bolivia and the Aguatuya Foundation, which promotes wastewater management and the use of the nutrients present in it, including the construction and implementation of treatment plants with a focus on reuse.

The Municipality of Tolata is located in a region with an agricultural tradition. However, rainfall in the area is relatively low (490 mm/year) and concentrated in 3 or 4 months of the year; therefore, there is an

unsatisfied demand for irrigation water in the area. Treated wastewater offers opportunities for a sustainable and reliable supplementary irrigation water supply for agriculture. Wastewater treatment that meets quality standards (treatment suitable for reuse) and its application to certain types of crops ensures responsible and safe reuse, and contributes to the local economy, as well as improving people's health and the environment.

Planning process In Bolivia, municipalities have exclusive competence for the planning and provision of basic services in their territories. In this particular case, the Municipality signed an inter-institutional agreement with the Swedish Embassy in Bolivia and Aguatuya to receive technical assistance in planning and improving basic services. The Municipality, through its Directorate of Basic Services, implemented sewerage services for the entire urban centre of the Municipality. Houses that are connected to the sewerage system discharge their wastewater (black water and greywater) into the network. The connection of rainwater to the sanitary sewer system

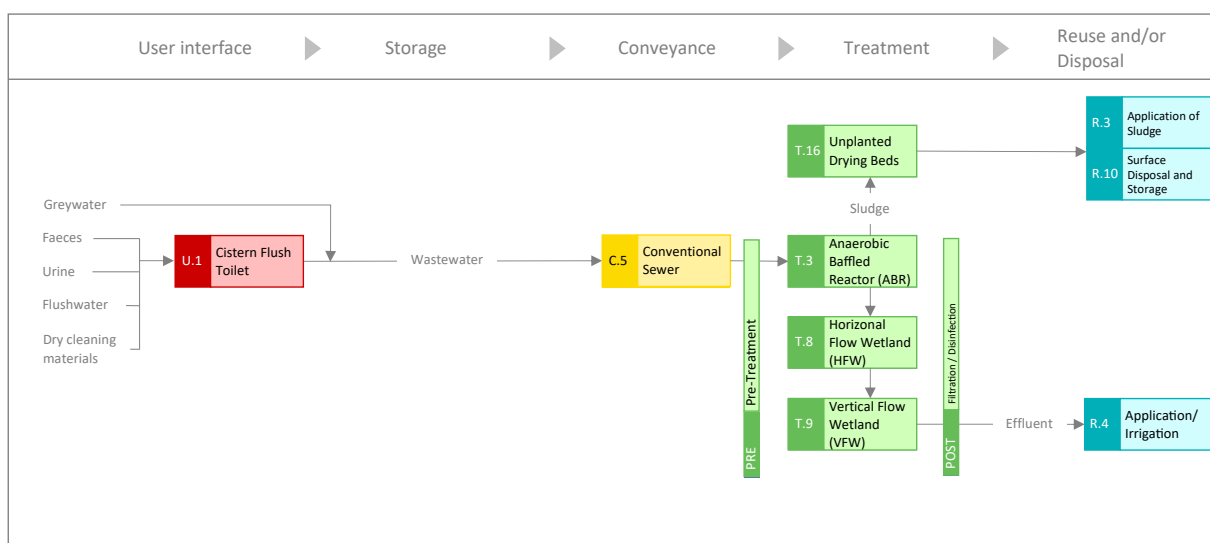

Figure 1: System diagram

is not permitted. The sewer network carries the collected water to the treatment plant by gravity. The complete sanitation chain is described in Figure 1.

Three aspects have been prioritised when planning and designing the Tolata wastewater treatment plant:

- i) Natural processes,
- ii) Lowest annual equivalent cost (LEC) and
- iii) Reuse approach to use the treated effluent for agricultural irrigation.

Wastewater treatment based on natural processes reduces the use of energy external to the treatment system, requires no chemicals and is environmentally friendly. Systems that use less energy generate lower operating and maintenance costs. The level of treatment is commensurate with the reuse activity, in this case, agricultural irrigation.

Taking these three principles into account, anaerobic treatment has been selected through the use of anaerobic compartmentalised reactors (ABR), combined with secondary treatment, in a configuration combining

horizontal gravel filters (HGF) and vertical flow gravel filters (VGF). The ABR technology was selected because of its simple design, unsophisticated equipment, high performance, low sludge production and low operating costs. The main advantage of the ABR is its ability to separate acidogenesis and methanogenesis longitudinally along the length of the reactor, allowing different populations of bacteria to dominate each compartment. Acidification dominates in the first compartment and methanogenesis dominates in the subsequent compartments (Barber and Stuckey, 1998). Although ABRs have been widely used, they alone cannot meet effluent quality requirements and their use requires a combination with other treatment technologies, hence the use of gravel filters.

HFW and VFW in wastewater treatment plants offer a robust treatment system at a very low cost compared to conventional treatment technologies. In addition, biofilters are necessary to filter ABR effluent before it is discharged and reused as supplementary irrigation for tall stem crops in surrounding areas.

Tab. 1: Selection of appropriate technologies

Local conditions	Technology appropriate to local conditions
Wastewater with relatively high concentrations of organic matter (BOD>400mg/l). Variable flow at the inlet of the plants due to small collection systems (length < 10 km).	Anaerobic treatment based on an anaerobic compartmentalised reactor (ABR).
The low-income population cannot afford to pay fees higher than 1.5 to 2.0 USD/month.	Natural processes that, where possible, do not require energy or supplies. Anaerobic treatment and artificial wetlands as secondary treatment.
Potential reuse of reclaimed water for irrigation of crops	Treatment without nutrient removal (N and P).
Crop irrigation	Restriction of crops to be irrigated with treated but not disinfected water. Irrigation restricted to tall-stemmed plants such as maize, alfalfa and forage (irrigation of vegetables such as tomatoes and lettuce is prohibited). Application of chlorination disinfection (only when necessary)

The technologies applied were selected and adapted to local conditions according to the criteria shown in Table 1.

Technical aspects

System design The configuration of the WWTP treatment train (see Figure 2) starts with a pumping station that receives the wastewater from the municipal sewage system and lifts it through a rotary screen, which separates all solids larger than 3 [mm]. Then the wastewater is conveyed to a grease separator with a hydraulic retention time of two minutes. Primary treatment is carried out in two ABRs arranged with a hydraulic retention time of nine hours during which the organic matter is broken down into simpler compounds under anoxic conditions. The walls and their baffles are made of glass fibre reinforced polyester (GRP). Secondary treatment is carried out in a configuration combining two HGFs and two VGFs arranged in parallel. The two HGFs occupy an area of approximately 509 m² (11 x 22.5 m each) and 0.8 [m] deep. The effluent from the HFGs passes through an aeration chamber before entering the VGFs, which occupy an area of 508 m² (11 x 22.5 m each) and are filled with medium-sized gravel. The treated wastewater is collected and directed to a chlorination chamber that is only used in emergency situations, such as the detection of an

epidemic. It is normally preferred not to chlorinate the treated wastewater to avoid the formation of toxic organochlorine compounds. The sludge accumulated at the bottom of the ABR is pumped out and deposited in the 194.5 m² (8.5 x 22.8 m), 0.15 m deep sludge drying area.

Treatment efficiency In accordance with current Bolivian regulations, the WWTP must comply with the following parameters for general discharges, according to Annex A2 of the Water Pollution Regulations of Law 1333 on the Environment. General discharges are considered to be those that are not discharged into a classified water body. In this case, the water will be used for agricultural irrigation and the rivers in the area have not been classified; therefore, the following quality control parameters of the treated water must be monitored periodically: BOD₅, COD and TSS. To determine the treatment efficiency of the plant, a series of monitoring campaigns were carried out from August to December 2018. The monitoring results are presented in Table 2. Based on these results, it

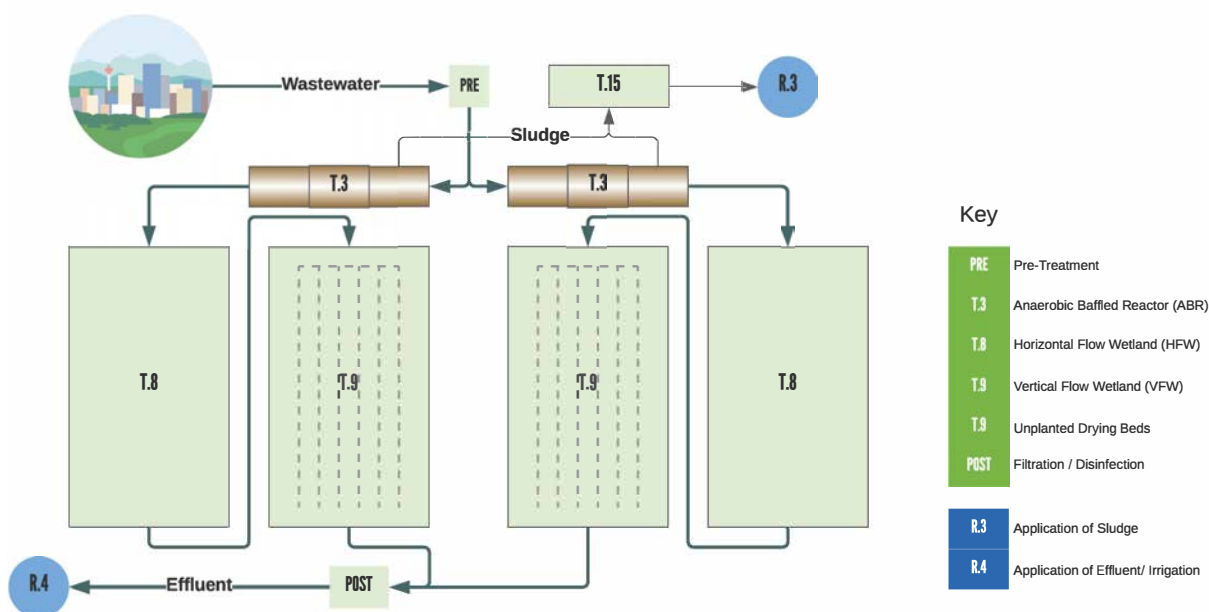

Figure 2: System layout

is concluded that it is advisable to use treated water only for irrigation of tall stem, grass and fodder crops that are not for direct human consumption to reduce health risks to the population and that have moderate salinity tolerance. Only treated effluent can be used on vegetables and other products that are eaten raw, using the disinfection process.

Institutional and regulatory aspects

Ownership and management function: This function is fulfilled by the municipality as the owner of the service/infrastructure. The municipality is responsible for the sustainability of the service over time and must ensure that the day-to-day operations are carried out effectively to meet the needs of the service users and the sustainability of the service over time.

Operation and maintenance (O&M) function: This function consists of performing daily operation and routine maintenance activities. To carry out this function, personnel with knowledge of the WWTP and its processes are required. In plants with a low level of

Tab. 2: Monitoring results (Organic matter and suspended solids)

Parameter	Tributary	Effluent	Limit according to regulations	Overall efficiency of the WWTP
BOD ₅ [mg/l]	396 ± 289	18 ± 12	80	95 %
COD [mg/l]	795 ± 262	95 ± 61	250	88 %
TSS [mg/l]	361 ± 113	18 ± 10	60	95 %

Table 3 shows the details of nutrient and pathogen removal according to the monitoring carried out.

Tab. 3: Monitoring results (Nutrients and electroconductivity)

Parameter	Tributary	Effluent
N-NH ₃ [mg/l]	66.0 ± 38.9	4.170 ± 26.50
P [mg/l]	11.8 ± 2.2	8.30 ± 2.20
EC conductivity [m-S/cm]	2.73 ± 1.13	2.35 ± 0.75

technological sophistication, as is the case of this plant, the function can be carried out by trained personnel who do not require prior technical training. In this case, this function has been outsourced to Aguatuya

on the basis of a service contract. This contract can be renewed every five years by mutual agreement between the parties. When the municipality has trained personnel, it can dispense with external services and operate the plant with its own resources.

Technical service function: Water quality monitoring (laboratory analysis), technical troubleshooting, upgrading and expansion projects of a WWTP are some of the main activities that need to be carried out to fulfil this. This function is normally carried out by wastewater engineers. In this case, it has been outsourced to Aguatuya as a specialised entity.

Figure 3 shows the functional management model implemented in this case.

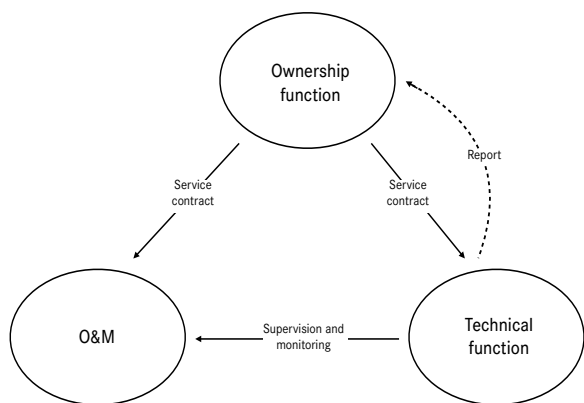

Figure 3: Functional management model

Financial aspects The implementation costs of the WWTP were determined, using the Annual Equivalent Cost (AEC) methodology, which considers not only the initial investment costs, but also all recurrent costs related to operation and maintenance. Aguatuya adopted this methodology to evaluate its treatment systems from a financial point of view in order to

optimise costs over time to make treatment services more economical and accessible to municipalities and end-users.

The total cost of the Tolata WWTP is \$257 694. The equivalent annual cost of this plant, considering an annual discount rate of 5%, is \$39 907/year. Of this amount, 56% (\$22 414/year) corresponds to CAPEX and 44% (\$16 716/year) to OPEX respectively. The total cost per capita is \$11/year and the cost per cubic metre of treated water is \$0.33.

Success/failure factors and lessons learned

One of the main success factors of this case has been the integration into the planning process of the farmers in the areas need irrigation water and who, since the project, have incorporated treated effluent as part of their agricultural practices. In this case, the sanitation process has been planned from the end, i.e. the design of the treatment system has taken into account the reuse activity (agricultural irrigation) with treated wastewater and the plant has been implemented in the area where the water is required.

An irrigation system restricted to maize and alfalfa crops has been implemented as a multiple barrier measure to prevent the irrigation of produce that is eaten raw, which would disinfect water for irrigation.

Another success factor has been the combination of anaerobic reactors with vertical wetlands that allow good organic load removal efficiencies. This technological solution, combined with the reuse of treated effluent in irrigation, allows for compliance with the regulations for general discharges and, at the same time, lowers treatment costs substantially, because nitrogen and phosphorus do not have to be removed at all the levels required when the water is to be discharged to a river or lake.

References & Further Reading

can be found on page 264



Figure 4: *The active involvement of the community in the planning of the wastewater treatment plant solved a problem that the Tolata Municipality alone could not: identifying the required land. It was offered by farmers near the facility - in exchange for access to the treated effluent for irrigation. The treatment plant was designed for this purpose, i.e. „from the end“ (p. 230 and chapter X 4.1, pp. 186-187).*

Glossary

Activated Sludge: See T.13

Aerated Pond: See T.6

Aerobic: Describes biological processes that occur in the presence of oxygen.

Aerobic Pond: A lagoon that forms the third treatment stage in Waste Stabilisation Ponds. See T.5 (Syn.: Maturation Pond, Polishing Pond)

Anaerobic: Describes biological processes that occur in the absence of oxygen.

Anaerobic Baffled Reactor (ABR): See S.4 and T.3

Anaerobic Digester: See T.18 (Syn.: Biogas Reactor)

Anaerobic Digestion: The degradation and stabilisation of organic compounds by microorganisms in the absence of oxygen, leading to production of biogas.

Anaerobic Filter: See S.5 and T.4

Anaerobic Pond: A lagoon that forms the first treatment stage in Waste Stabilisation Ponds. See T.5

Anal Cleansing Water: See Products, p. 12

Anoxic: Describes the process by which nitrate is biologically converted to nitrogen gas in the absence of oxygen. This process is also known as denitrification.

Application of Dehydrated Faeces: See R.2

Application of Sludge: See R.3

Application of Stored Urine: See R.1

Aquaculture: The controlled cultivation of aquatic plants and animals. See Fish Pond (R.7) and Floating Plant Pond (R.8)

Aquifer: An underground layer of permeable rock or sediment (usually gravel or sand) that holds or transmits groundwater.

Bacteria: Simple, single cell organisms that are found everywhere on earth. They are essential for maintaining life and performing essential “services”, such as composting, aerobic degradation of waste and digesting food in our intestines. Some types, however, can be pathogenic and cause mild to severe illnesses. Bacteria obtain nutrients from their environment by excreting enzymes that dissolve complex molecules into more simple ones which can then pass through the cell membrane.

Bar Rack: See PRE, p. 76 (Syn.: Trash Trap)

Biochar: See Products, p. 12 and R.12

Biochemical Oxygen Demand (BOD): A measure of the amount of oxygen used by microorganisms to degrade organic matter in water over time (expressed in mg/L and normally measured over five days as BOD₅). It is an indirect measure of the amount of biodegradable organic material present in water or wastewater: the more the organic content, the more oxygen is required to degrade it (high BOD).

Biodegradation: Biological transformation of organic material into more basic compounds and elements (e.g., carbon dioxide, water) by bacteria, fungi and other microorganisms.

Biogas: See Products, p. 12

Biogas Combustion: See R.11

Biogas Reactor: See T.18 (Syn.: Anaerobic Digester)

Biomass: See Products, p. 12

Blackwater: See Products, p. 12

Brackish Water: Water with more salinity than fresh water but less than seawater (1,000 - 10,000 mg/L total dissolved solids). It is usually the result of seawater intrusion into groundwater bodies along coastal areas.

Brownwater: See Products, p. 12

Capital Cost: Funds spent for the acquisition of a fixed asset, such as sanitation infrastructure.

Carbonisation: See T.19

Centralised Treatment: See Functional Group T, p. 74

Cesspit: An ambiguous term either used to describe a Soak Pit (Leach Pit), or a Holding Tank. (Syn.: Cesspool)

Cesspool: See Cesspit (Syn.)

Chemical Oxygen Demand (COD): A measure of the amount of oxygen required for chemical oxidation of organic material in water by a strong chemical oxidant (expressed in mg/L). COD is always equal to or higher than BOD since it is the total oxygen required for complete oxidation. It is an indirect measure of the amount of organic material present in water or wastewater: the more the organic content, the more oxygen is required to chemically oxidise it (high COD).

Cistern Flush Toilet: See U.1

Clarifier: See T.1 (Syn.: Settler, Sedimentation/Settling Tank/Basin)

C:N Ratio: The ratio of the mass of carbon to the mass of nitrogen in a substrate.

Coagulation: The destabilisation of particles in water by adding chemicals (e.g., aluminium sulphate or ferric chloride) so that they can aggregate and form larger flocs.

Co-Composting: See T.17

Collection and Storage/Treatment: See Functional Group S, p. 48

Compost: See Products, p. 12

Composting: The process by which biodegradable components are biologically decomposed by microorganisms (mainly bacteria and fungi) under controlled aerobic conditions.

Condominial Sewer: See C.3 (Syn.: Simplified Sewer)

Constructed Wetland: A treatment technology for wastewater that aims to replicate the naturally occurring processes in wetlands, now called “Wetlands”. See T.7-T.10

Conventional Gravity Sewer: See C.5

Conveyance: See Functional Group C, p. 62

Cyst: An environmentally resistant stage of a microorganism that helps it to survive periods of environmentally harsh conditions. Some protozoan parasites form infective, highly resistant cysts (e.g., Giardia) and oocysts (thick-walled spores, e.g., Cryptosporidium) during their life cycle.

Decentralised Wastewater Treatment System (DEWATS): A small-scale system used to collect, treat, discharge and/or reclaim wastewater from a small community or service area.

Dehydrated Faeces: See Products, p. 13 (Syn.: Dried Faeces)

Desludging: The process of removing the accumulated sludge from a storage or treatment facility.

Detention Time: See Hydraulic Retention Time (Syn.)

Dewatering: The process of reducing the water content of a sludge or slurry. Dewatered sludge may still have a significant moisture content, but it typically is dry enough to be conveyed as a solid (e.g., shovelled).

Digestate: The solid and/or liquid material remaining after undergoing anaerobic digestion.

Disinfection: The elimination of (pathogenic) microorganisms by inactivation (using chemical agents, radiation or heat) or by physical separation processes (e.g., membranes). See POST, p. 116

Disposal: See Functional Group R, p. 118

Dried Faeces: See Products, , p. 13 (Syn.: Dehydrated Faeces)

Dry Cleansing Materials: See Products, , p. 13

Dry Toilet: See U.4

E. coli: Escherichia coli, a bacterium inhabiting the intestines of humans and warm-blooded animals. It is used as an indicator of faecal contamination of water.

Ecological Sanitation (EcoSan): An approach that aims to safely recycle nutrients, water and/or energy contained in excreta and wastewater in such a way that the use of non-renewable resources is minimised. (Syn.: Resources-Oriented Sanitation)

Effluent: See Products, , p. 13

Emerging Technology: A technology that has moved beyond the laboratory and small-pilot phase and is being implemented at a scale that indicates that expansion is possible. See p. 147

End-Use: The utilisation of products derived from a sanitation system. (Syn.: Use, in this Compendium: Reuse)

Environmental Sanitation: Interventions that reduce people exposure to disease by providing a clean environment in which to live, with measures to break the cycle of disease. This usually includes hygienic management of human and animal excreta, solid waste, wastewater and stormwater; the control of disease vectors; and the provision of washing facilities for personal and domestic hygiene. Environmental Sanitation involves both behaviours and facilities that work together to form a hygienic environment.

Eutrophication: The enrichment of water, both fresh and saline, by nutrients (especially the compounds of nitrogen and phosphorus) that accelerate the growth of algae and higher forms of plant life and lead to the depletion of oxygen.

Evaporation: The phase change from liquid to gas that takes place below the boiling temperature and normally occurs on the surface of a liquid.

Evapotranspiration: The combined loss of water from a surface by evaporation and plant transpiration.

Excreta: See Products, p. 13

Facultative Pond: A lagoon that forms the second treatment stage in Waste Stabilisation Ponds. See T.5

Faecal Sludge: See Product Sludge, p. 14

Faeces: See Products, p. 13

Filtrate: The liquid that has passed through a filter.

Filtration: A mechanical separation process using a porous medium (e.g., cloth, paper, sand bed, or mixed media bed) that captures particulate material and permits the liquid or gaseous fraction to pass through. The size of the pores of the medium determines what is captured and what passes through.

Fish Pond: See R.7

Flotation: The process whereby lighter fractions of a wastewater, including oil, grease, soaps, etc., rise to the surface and thereby can be separated.

Floating Plant Pond: See R.8 (Syn.: Macrophyte Pond)

Floating Treatment Wetland: See T.10 (Syn.: Green Floating Filter)

Flocculation: The process by which the size of particles increases as a result of particle collision. Particles form aggregates or flocs from finely divided particles and from chemically destabilized particles and can then be removed by settling or filtration.

Flushwater: See Products, p. 13

Free-Water Surface Wetland: See T.7

Functional Group: See Compendium Terminology, p. 14

Grease Trap: See PRE, p. 76

Green Floating Filter: See Floating Treatment Wetland (Syn.) T.10

Greywater: See Products, p. 14

Grit Chamber: See PRE, p. 76 (Syn.: Sand Trap)

Groundwater: Water that is located beneath the earth's surface.

Groundwater Recharge: See R.9

Groundwater Table: The level below the earth's surface which is saturated with water. It corresponds to the level where water is found when a hole is dug or drilled. A groundwater table is not static and can vary by season, year or usage (Syn.: Water Table).

Hand-Powered Emptying and Transport: See C.1

Holding Tank: See S.2

Helminth: A parasitic worm, i.e. one that lives in or on its host, causing damage. Some examples that infect humans are roundworms (e.g., Ascaris and hookworm) and tapeworms. The infective eggs of helminths can be found in excreta, wastewater and sludge. They are very resistant to inactivation and may remain viable in faeces and sludge for several years.

Horizontal Flow Wetland: See T.8

Humus: The stable remnant of decomposed organic material. It improves soil structure and increases water retention, but has no nutritive value.

Hydraulic Retention Time (HRT): The average amount of time that liquid and soluble compounds stay in a reactor or tank. (Syn.: Detention Time)

Imhoff Tank: See T.2

Improved Sanitation: Facilities that ensure hygienic separation of human excreta from human contact.

Influent: The general name for the liquid that enters into a system or process (e.g., wastewater).

Irrigation: See R.4

Jerrycan: A robust liquid plastic container made mostly from high density polyethylene.

Leachate: The liquid fraction that is separated from the solid component by gravity filtration through media (e.g., liquid that drains from drying beds).

Leach Field: See R.6

Leach Pit: See Soak Pit (Syn.)

Lime: The common name for calcium oxide (quicklime, CaO) or calcium hydroxide (slaked or hydrated lime, Ca(OH)₂). It is a white, caustic and alkaline powder produced by heating lime-

stone. Slaked lime is less caustic than quicklime and is widely used in water/wastewater treatment and construction (for mortars and plasters).

Log Reduction: Organism removal efficiencies. 1 log unit = 90%, 2 log units = 99%, 3 log units = 99.9%, and so on.

Macrophyte Pond: See R.8 (Syn.: Floating Plant Pond)

Macrophyte: An aquatic plant large enough to be readily visible to the naked eye. Its roots and differentiated tissues may be emergent (reeds, cattails, bulrushes, wild rice), submergent (water milfoil, bladderwort) or floating (duckweed, lily pads).

Maturation Pond: See in T.5 Aerobic Pond (Syn.)

Methane: A colourless, odourless, flammable, gaseous hydrocarbon with the chemical formula CH₄. Methane is present in natural gas and is the main component (50-75%) of biogas that is formed by the anaerobic decomposition of organic matter.

Microorganism: Any cellular or non-cellular microbiological entity capable of replication or of transferring genetic material (e.g., archaea, bacteria, viruses, protozoa, algae or fungi).

Micropollutant: Pollutant that is present in extremely low concentrations (e.g., trace organic compounds).

Motorised Emptying and Transport: See C.2

Night Soil: A historical term for faecal sludge.

Nutrient: Any substance that is used for growth. Nitrogen (N), phosphorus (P) and potassium (K) are the main nutrients contained in agricultural fertilizers. N and P are also primarily responsible for the eutrophication of water bodies.

Offsite Sanitation: A sanitation system in which excreta and wastewater are collected and conveyed away from the plot where they are generated. An offsite sanitation system relies on a sewer technology (see C.3-C.5) for conveyance.

Onsite Sanitation: A sanitation system in which excreta and wastewater are collected and stored or treated on the plot where they are generated.

Oocyst: See Cyst

Operation and Maintenance (O&M): Routine or periodic tasks required to keep a process or system functioning according to performance requirements and to prevent delays, repairs or downtime.

Organics: See Products, p. 14

Parasite: An organism that lives on or in another organism and damages its host.

Pathogen: An organism or other agent that causes disease.

Percolation: The movement of liquid through a filtering medium with the force of gravity.

pH: The measure of acidity or alkalinity of a substance. A pH value below 7 indicates that it is acidic, a pH value above 7 indicates that it is basic (alkaline).

Planted Drying Beds: See T.16

Polishing Pond: See in T.5 Aerobic Pond (Syn.)

Post-Treatment: See POST, p. 116 (Syn.: Tertiary Treatment)

Pre-Treatment: See PRE, p. 76

Pre-Treatment Products: See Products, p. 14

Primary Treatment: The first major stage in wastewater treatment that removes solids and organic matter mostly by the process of sedimentation or flotation and is defined as: treatment of wastewater by a physical and/or chemical process involving settlement of suspended solids, or any other process in which the Biochemical Oxygen Demand (BOD) of the incoming wastewater is reduced by at least 20 per cent before discharge (UN Habitat and WHO, 2021).

Product: See Compendium Terminology, p. 12

Protozoa: A diverse group of unicellular eukaryotic organisms, including amoeba, ciliates and flagellates. Some can be pathogenic and cause mild to severe illnesses.

Reclaimed Water: Wastewater after treatment that can be reused for a variety of purposes.

Resources-Oriented Sanitation: See Ecological Sanitation (Syn.)

Reuse: The utilisation of products derived from a sanitation system.

Reuse and/or Disposal: See functional group R, p. 118

Runoff: see Surface Runoff

Sand Trap: See PRE, p. 76 (Syn.: Grit Chamber)

Sanitation: The means of safely collecting and hygienically disposing of excreta and liquid wastes for the protection of public health and the preservation of the quality of public water bodies and, more generally, of the environment.

Sanitation System: See Compendium Terminology, p. 12

Sanitation Technology: see Compendium Terminology, p. 12

Screen: See PRE, p. 76 (Syn.: Bar Rack, Trash Trap)

Scum: The layer of solids formed by wastewater constituents that float to the surface of a tank or reactor (e.g., oil and grease).

Secondary Treatment: Follows primary treatment to achieve the removal of biodegradable organic matter and suspended solids from effluent and is defined as: post-primary treatment of wastewater by a process generally involving biological treatment with a secondary settlement or other process, resulting in a BOD removal of at least 70 per cent and a Chemical Oxygen Demand (COD) removal of at least 75 per cent. Natural biological treatment processes are also considered (UN Habitat and WHO, 2021).

Sedimentation: Gravity settling of particles in a liquid such that they accumulate. (Syn.: Settling)

Sedimentation Tank/Basin: See T.1 (Syn.: Settler, Clarifier, Settling Tank/Basin)

Sedimentation/Thickening Ponds: See T.14

(Semi-) Centralised Treatment: See Functional Group T, p. 74

Septage: A historical term to define sludge removed from septic tanks.

Septic: Describes the conditions under which putrefaction and anaerobic digestion take place.

Septic Tank: See S.3

Settled Sewer: See C.4 (Syn.: Solids-Free Sewer, Small-Bore Sewer)

Settler: See T.1 (Syn.: Clarifier, Sedimentation/Settling Tank/Basin)

Settling: See Sedimentation (Syn.)

Settling Tank/Basin: See T.1 (Syn.: Settler, Clarifier, Sedimentation Tank/Basin)

Sewage: Waste matter that is transported through the sewer.

Sewer: An open channel or closed pipe used to convey sewage. See C.3-C.5

Sewerage: The physical sewer infrastructure (sometimes used interchangeably with sewage).

Simplified Sewer: See C.3 (Syn.: Condominium Sewer)

Sitter: Someone who prefers to sit on the toilet, rather than squat over it.

Sludge: See Products, p. 14

Small-Bore Sewer: See C.4 (Syn.: Solids-Free Sewer, Settled Sewer)

Soak Pit: See R.5 (Syn.: Leach Pit)

Soil Conditioner: A product that enhances the water and nutrient retaining properties of soil.

Solids-Free Sewer: See C.4 (Syn.: Small-Bore Sewer, Settled Sewer)

Specific Surface Area: The ratio of the surface area to the volume of a solid material (e.g., filter media).

Squatter: Someone who prefers to squat over the toilet, rather than sit directly on it.

Stabilisation: The degradation of organic matter with the goal of reducing readily biodegradable compounds to lessen environmental impacts (e.g., oxygen depletion, nutrient leaching).

Stored Urine: See Products, p. 14

Stormwater: See Products, p. 14

Sullage: A historical term for greywater.

Submerged Aerated Fixed-Film Reactor: See S.6

Superstructure: The walls and roof built around a toilet or bathing facility to provide privacy and protection to the user.

Surface Disposal and Storage: See R.10

Surface Runoff: The portion of precipitation that does not infiltrate the ground and runs overland.

Surface Water: A natural or man-made water body that appears on the surface, such as a stream, river, lake, pond, or reservoir.

System Template: See Part 1, pp. 16-21

Tertiary Filtration: Application of filtration processes for tertiary treatment of effluent. See POST, p. 116

Tertiary Treatment: Follows secondary treatment to achieve enhanced removal of pollutants from effluent. Nutrient removal (e.g., phosphorus) and disinfection can be included in the definition of secondary treatment or tertiary treatment, depending on the configuration. See POST, p. 116 (Syn.: Post-Treatment) According UN-Water: The treatment of nitrogen and/or phosphorous and/or any other pollutant affecting the quality or a specific use of water (microbiological pollution, colour, etc.; UN Habitat and WHO, 2021, Box 3, p. 9)

Thickening Ponds: See T.14

Toilet: See U.1, U.3 and U.4, User interface for urination and defecation.

Total Solids (TS): The residue that remains after filtering a water or sludge sample and drying it at 105 °C (expressed in mg/L). It is the sum of Total Dissolved Solids (TDS) and Total Suspended Solids (TSS).

Trash Trap: See PRE, p. 76 (Syn.: Screen, Bar Rack)

Trickling Filter: See T.11

Underground Holding Tank: See S.2

Unplanted Drying Beds: See T.145

Upflow Anaerobic Sludge Blanket Reactor (UASB):
See T.12

Urea: The organic molecule (NH₂)CO₂ that is excreted in urine and that contains the nutrient nitrogen. Over time, urea breaks down into carbon dioxide and ammonium, which is readily used by organisms in soil.

Urinal: See U.2

Urine: See Products, p. 14

Urine-Diverting Dry Toilet (UDDT): See U.24

Urine-Diverting Flush Toilet (UDFT): See U.3

Urine Storage Tank: See S.1

User Interface: See Functional Group U, p. 38

Vector: An organism (most commonly an insect) that transmits a disease to a host. For example, flies are vectors as they can carry and transmit pathogens from faeces to humans.

Vertical Flow Wetland: See T.9

Virus: An infectious agent consisting of a nucleic acid (DNA or RNA) and a protein coat. Viruses can only replicate in the cells of a living host. Some pathogenic viruses are known to be water-borne (e.g., the rotavirus that can cause diarrheal disease).

Washer: Someone who prefers to use water to cleanse after defecating, rather than wipe with dry material.

Waste Stabilisation Ponds (WSP): See T.5

Wastewater: Used water from any combination of domestic, industrial, commercial or agricultural activities, surface runoff/stormwater and any sewer inflow/infiltration.
See Products, p. 14.

Water Disposal: See R.9

Water Table: See Groundwater Table (Syn.)

Wiper: Someone who prefers to use dry material (e.g., toilet paper or newspapers) to cleanse after defecating, rather than wash with water.

References & Further Reading

Introduction

- _ Sklar, R., Faustin, C., (2017). *Pit Latrines or Container Based Toilets?* Haiti Priorise. Copenhagen Consensus Center. Denmark. Available at: www.copenhagenconsensus.com

Outside the safe operating space of the planetary boundary for novel entities (2022)

The authors submit that the safe operating space of the planetary boundary of novel entities is exceeded since annual production and releases are increasing at a pace that outstrips the global capacity for assessment and monitoring. They recommend taking urgent action to reduce the production and release of these novel entities, including plastic and other substances.

- _ Persson, L., Almqvist, B.C., Collins, C.D. et al. (2022). *Outside the Safe Operating Space of the Planetary Boundary for Novel Entities*. *Environ. Sci. Technol.* 2022, 56, 3, 1510–1521. Available at doi: [10.1021/acs.est.1c04158](https://doi.org/10.1021/acs.est.1c04158)

Crossing the boundaries in global sustainability (2015)

The planetary boundary (PB) concept, introduced in 2009, aimed to define the environmental limits within which humanity can safely operate. This approach has proved influential in global sustainability policy development. Steffen et al. provide an updated and extended analysis of the PB framework. Of the original nine proposed boundaries, they identify three (including climate change) that might push the Earth system into a new state if crossed and that also have a pervasive influence on the remaining boundaries. They also develop the PB framework so that it can be applied usefully in a regional context.

- _ Steffen, W., Richardson, K., Rockstrom, J. et al. (2015). *Planetary Boundaries: Guiding Human Development on a Changing Planet*. *Science* 2015, 347 (6223), 1259855–1259855. Available at doi: [10.1126/science.1259855](https://doi.org/10.1126/science.1259855)

Compendium Terminology

- _ Rose, C., Parker, A., Jefferson, B., & Cartmell, E. (2015). *The Characterization of Feces and Urine: A Review of the Literature to Inform Advanced Treatment Technology*. *Crit. Rev. Environ. Sci. Technol.* 45, 1827–1879. Available at doi: [10.1080/10643389.2014.1000761](https://doi.org/10.1080/10643389.2014.1000761)
- _ Morel, A. and Diener, S. (2006). *Greywater Management in Low- and Middle-Income Countries. Review of Different Treatment Systems for Households or Neighbourhoods*. Swiss Federal Institute of Aquatic Science and Technology (Eawag), Dübendorf, CH. Available free for download at: www.sandec.ch

U.1

- _ Maki, B. (2005). *Assembling and Installing a New Toilet*. Hammerzone.com Available at: www.hammerzone.com (Describes how to install a toilet with full colour photos and step-by-step instructions)
- _ Benett, M. (2018). *How do Pressure Assist Toilets Work. Shower Redefined*. Available at: <https://showerredefined.com/how-do-pressure-assist-toilets-work/>
- _ ToiletReviewer.com (2020). *The 5 Best Pressure-Assist Toilets (Reviews and Rankings)* Available at: <https://toiletreviewer.com/pressure-assist-toilets>
- _ Vandervort, D. (2007). *Toilets: Installation and Repair*. HomeTips.com. Available at: www.hometips.com/bathroom_toilets.html (Describes each part of the toilet in detail and provides links to other tools, such as how to install a toilet, how to fix a leaking toilet and other toilet essential)

U.2

- Eawag, Wafler, M., Spuhler, D., Stauffer, B. (2020). *Waterless Urinals and Flush Urinals*. – SSWM Factsheet
Available at: <https://sswm.info/humanitarian-crises/camps/sanitation/user-interface/waterless-urinals-and-flush-urinals>
- von Münch, E. and Dahm, P. (2009). *Waterless Urinals: A Proposal to Save Water and Recover Urine Nutrients in Africa*. 34th WEDC International Conference. Addis Ababa, ET.
Available at: www.susana.org/en/knowledge-hub/resources-and-publications/library/details/890
- von Münch, E. and Winker, M. (2011). *Technology Review of Urine Diversion Components. Overview of Urine Diversion Components Such as Waterless Urinals, Urine Diversion Toilets, Urine Storage and Reuse Systems*. Gesellschaft für Internationale Zusammenarbeit (GIZ) GmbH, Eschborn, DE.
Available at: www.susana.org/en/knowledge-hub/resources-and-publications/library/details/875

U.3

- EOOS (2020). *Save! – Smart Sanitation for a sustainable future*. Laufen, Laufen, CH.
Available at: <http://publications.laufen.com/62524/1173855/>
- EOOS (2018). “The Urine Trap Folder” <https://urinetrap.com/src/assets/img/UrineTrap.pdf>
- EnviroSan (2021). *EaziSplit hybrid low flush urine diversion sanitation technology, EOOS “urine trap” design (SASTEP Project)*, EnviroSan, eThekweni, ZA. Available at: www.envirosan.co.za
- Mitchell, C., Fam, D., Abeysuriya, K. (2013). *Transitioning to sustainable sanitation – A transdisciplinary project of urine diversion*. Institute for Sustainable Futures, University of Technology Sydney, Australia
Available at: www.susana.org/en/knowledge-hub/resources-and-publications/library
- Kvarnström, E., Emilsson, K., Richert Stintzing, A., Johansson, M., Jönsson, H., af Petersens, E., Schönning, C., Christensen, J., Hellström, D., Qvarnström, L., Ridderstolpe, P. and Drangert, J.-O. (2006). *Urine Diversion: One Step Towards Sustainable Sanitation*. Report 2006–1, EcoSanRes: Ecosan Publications Series, Stockholm, SE.
Available at: www.ecosanres.org/publications.htm
- Wostmann Ecoflush urine diverting toilet brochure, manual and user manual,
Available at: www.wostman.se/en/support
- von Münch, E. and Winker, M. (2011). *Technology Review of Urine Diversion Components. Overview of Urine Diversion Components Such as Waterless Urinals, Urine Diversion Toilets, Urine Storage and Reuse Systems*. Gesellschaft für Internationale Zusammenarbeit (GIZ) GmbH, Eschborn, DE.
Available at: www.susana.org/en/knowledge-hub/resources-and-publications/library/details/875
- Winker, M. and Saadoun, A. (2011). *Urine and Brownwater Separation at GTZ Main Office Building Eschborn, Germany – Case Study of Sustainable Sanitation Projects*. Sustainable Sanitation Alliance (SuSanA), Eschborn, DE.
Available at: www.susana.org/en/knowledge-hub/resources-and-publications/case-studies/details/63

U.4

- Mijthab, M., Anisie, R. & Crespo, O. Mosan (2021). *Combining Circularity and Participatory Design to Address Sanitation in Low-Income Communities*. *Circ.Econ.Sust.* 1, 1165–1191 (2021). <https://doi.org/10.1007/s43615-021-00118-w>
- Russel, KC., Hughes, K., Roach, M., Auerbach, D., Foote, A., Kramer, S. and Briceño, R. R. (2019). *Taking Container-Based Sanitation to Scale: Opportunities and Challenges*. *Front. Environ. Sci.* 7:190. Available at doi: 10.3389/fenvs.2019.00190
- World Bank (2019). *Evaluating the Potential of Container-Based Sanitation*. World Bank, Washington, DC. Available at: <http://hdl.handle.net/10986/31292>
- World Bank (2019). *Evaluating the Potential of Container-Based Sanitation: SOIL in Cap-Haitien, Haiti*. World Bank, Washington, DC. Available at: <http://hdl.handle.net/10986/31295>
- World Bank (2019). *Evaluating the Potential of Container-Based Sanitation : x-runner in Lima, Peru*. World Bank, Washington, DC. Available at: <http://hdl.handle.net/10986/31293>
- von Münch, E. and Winker, M. (2011). *Technology Review of Urine Diversion Components. Overview of Urine Diversion Components Such as Waterless Urinals, Urine Diversion Toilets, Urine Storage and Reuse Systems*. Gesellschaft für Internationale Zusammenarbeit (GIZ) GmbH, Eschborn, DE. Available at: www.susana.org/en/knowledge-hub/resources-and-publications/library/details/875

S.1

- Kvarnström, E., Emilsson, K., Richert Stintzing, A., Johansson, M., Jönsson, H., af Petersens, E., Schönning, C., Christensen, J., Hellström, D., Qvarnström, L., Ridderstolpe, P. and Drangert, J.-O. (2006). *Urine Diversion: One Step Towards Sustainable Sanitation*. Report 2006-1, EcoSanRes: Ecosan Publications Series, Stockholm, SE. Available at: www.ecosanres.org/publications.htm
- von Münch, E. and Winker, M. (2011). *Technology Review of Urine Diversion Components. Overview of Urine Diversion Components Such as Waterless Urinals, Urine Diversion Toilets, Urine Storage and Reuse Systems*. Gesellschaft für Internationale Zusammenarbeit (GIZ) GmbH, Eschborn, DE. Available at: www.susana.org/en/knowledge-hub/resources-and-publications/library/details/875
- Wald, C. (2022). *The urine revolution: how recycling pee could help save the world*. *Nature*, Springer Nature Ltd., Vol 602, p.202-206. Available at: www.nature.com/articles/d41586-022-00338-6
- WHO (2006). *Guidelines for the Safe Use of Wastewater, Excreta and Greywater*. Volume 4: Excreta and Greywater Use in Agriculture. World Health Organization, Geneva, CH. Available at: www.who.int

S.2

- Texas A&M. On-Site Sewage Facilities (OSSF) online facility Available at: <https://ossf.tamu.edu/holding-tank/>
- Washington State Department of Health, (2021). *Recommended Standards and Guidance for Performance, Application, Design, and Operation & Maintenance Holding Tank Sewage System* Available at: www.doh.wa.gov/portals/1/Documents/Pubs/337-006.pdf

S.3

- Crites, R. and Tchobanoglous, G. (1998). *Small and Decentralized Wastewater Management Systems*. WCB/McGraw-Hill, New York, US.
- Mara, D. D. (1996). *Low-Cost Urban Sanitation*. Wiley, Chichester, UK.
(Sizing, volume and emptying calculations and example design solutions – Chapter 6)
- Oxfam (2008). *Septic Tank Guidelines. Technical Brief*. Oxfam GB, Oxford, UK.
Available at: policy-practice.oxfam.org.uk
- Polprasert, C. and Rajput, V. S. (1982). *Environmental Sanitation Reviews. Septic Tank and Septic Systems*. Environmental Sanitation Information Center, AIT, Bangkok, TH.
Available at: www.susana.org/_resources/documents/default/3-2995-7-1519811046.pdf
(Comprehensive design manual)
- Ulrich, A. (Ed.), Reuter, S. (Ed.), Gutterer, B. (Ed.), Sasse, L., Panzerbieter, T. and Reckerzügel, T. (2009). *Decentralised Wastewater Treatment Systems (DEWATS) and Sanitation in Developing Countries. A Practical Guide*. WEDC, Loughborough University, Leicestershire, Available at: <https://wedc-knowledge.lboro.ac.uk/details.html?id=10409>

S.4

- Bachmann, A., Beard, V. L. and McCarty, P. L. (1985). *Performance Characteristics of the Anaerobic Baffled Reactor*. *Water Research* 19 (1): 99-106.
- Barber, W. P. and Stuckey, D. C. (1999). *The Use of the Anaerobic Baffled Reactor (ABR) for Wastewater Treatment: A Review*. *Water Research* 33 (7): 1559-1578.
- Foxon, K. M., Buckley, C. A., Brouckaert, C. J., Dama, P., Mtembu, Z., Rodda, N., Smith, M., Pillay, S., Arjun, N., Lalbahadur, T. and Bux, F. (2006). *Evaluation of the Anaerobic Baffled Reactor for Sanitation in Dense Peri-urban Settlements*. WRC Report No 1248/01/06, Water Research Commission, Pretoria, ZA. Available at: www.wrc.org.za
- Foxon, K. M., Pillay, S., Lalbahadur, T., Rodda, N., Holder, F. and Buckley, C. A. (2004). *The Anaerobic Baffled Reactor (ABR): An Appropriate Technology for on-Site Sanitation*. *Water SA* 30 (5) (Special Edition). Available at: www.wrc.org.za
- Stuckey, D. C. (2010). *Anaerobic Baffled Reactor (ABR) for Wastewater Treatment*. In: *Environmental Anaerobic Technology. Applications and New Developments*, H. H. P. Fang (Ed.), Imperial College Press, London, UK.
- Ulrich, A. (Ed.), Reuter, S. (Ed.), Gutterer, B. (Ed.), Sasse, L., Panzerbieter, T. and Reckerzügel, T. (2009). *Decentralised Wastewater Treatment Systems (DEWATS) and Sanitation in Developing Countries. A Practical Guide*. WEDC, Loughborough University, Leicestershire, UK. Available at: <https://wedc-knowledge.lboro.ac.uk/details.html?id=10409>

S.5

- Morel, A. and Diener, S. (2006). *Greywater Management in Low and Middle-Income Countries. Review of Different Treatment Systems for Households or Neighbourhoods*. Eawag (Department Sandec), Dübendorf, CH.
Available at: www.sandec.ch (Short summary including case studies – p. 28)
- von Sperling, M. and de Lemos Chernicharo, C. A. (2005). *Biological Wastewater Treatment in Warm Climate Regions*, Volume One. IWA Publishing, London, UK. pp. 728-804. Available at: doi: 10.2166/9781780402734
(Detailed design instructions)
- Ulrich, A. (Ed.), Reuter, S. (Ed.), Gutterer, B. (Ed.), Sasse, L., Panzerbieter, T. and Reckerzügel, T. (2009). *Decentralised Wastewater Treatment Systems (DEWATS) and Sanitation in Developing Countries. A Practical Guide*. WEDC, Loughborough University, Leicestershire, UK. Available at: <https://wedc-knowledge.lboro.ac.uk/details.html?id=10409>
(Design summary including Excel spreadsheets for design calculations)

S.6

- EPA Decentralized Wastewater Program (2005). *Decentralized wastewater treatment can protect the environment, public health, and water quality*. Available at: www.epa.gov/sites/default/files/2015-06/documents/mou-public-health-paper-081712.pdf
- Siegrist, R. L. (2017). *Introduction to Decentralized Infrastructure for Wastewater Treatment and Water Reclamation*. In: *Decentralized Water Reclamation Engineering*. Springer, Cham. Available at doi: 10.1007/978-3-319-40472-1_1
- Utilities Tech Outlook, (2019). *Effective Wastewater Treatment for Sustainable Future. Top 10 Wastewater Management Solution Companies - 2019*. Available at: <https://waste-water-management.utilitiestechoutlook.com/vendors/top-wastewater-management-solution-companies-2019.html>

C.1

- During, A. et al. (2001). *Start Your Waste Collection Services (p. 49). Waste Transportation Equipment used in Latin America*. ILO Technical Handouts. Lusaka. Zambia. Available at: www.ilo.org/wcmsp5/groups/public/@ed_emp/@emp_policy/@invest/documents/instructionalmaterial/wcms_asist_8526.pdf
- Russel, K., Montgomery, I. (2020). *Container-Based Sanitation Implementation Guide 1st Edition*. Container-Based Sanitation Alliance, UK, London. Available at: <https://cbsa.global/resources>
- Sustainable Organic Integrated Livelihoods (2019). *Sanitation Safety Planning - Applying the WHO methodology to SOIL's operations in Northern Haiti*. Sustainable Organic Integrated Livelihoods. Haiti. Available at: www.susana.org/_resources/documents/default/3-4914-340-1647807343.pdf

C.2

- Strande, L., Ronteltap, M. and Brdjanovic, D. (Eds.) (2014). *Faecal Sludge Management. Systems Approach for Implementation and Operation*. IWA Publishing, London, UK. Available at: www.sandec.ch/fsm_book (Detailed book compiling the current state of knowledge on all aspects related to FSM)
- Gurski, T., Hennessy, S., Rogers, T., Shaw, J. (2022). *Practical Guide to Available Pit-Emptying Technologies*. Available at: <https://fsm-alliance.glueup.com/event/fsma-spotlights-a-practical-guide-to-available-pit-emptying-technologies-48207/> (Available along with a filterable chart and webinar slides from Faecal Sludge Management Alliance (FSMA))

C.3

- Bakalian, A., Wright, A., Otis, R. and Azevedo Netto, J. (1994). *Simplified Sewerage: Design Guidelines*. UNDP-World Bank Water and Sanitation Program, Washington, D.C., US. Available at: <https://documents.worldbank.org/curated/en/home> (Design guidelines for manual calculations)
- Mara, D. D. (1996a). *Low-Cost Sewerage*. Wiley, Chichester, UK. (Assessment of different low-cost systems and case studies)
- Mara, D. D. (1996b). *Low-Cost Urban Sanitation*. Wiley, Chichester, UK. pp. 109-139. (Comprehensive summary including design examples)

- _ Mara, D. D. (2005). *Sanitation for All in Periurban Areas? Only If We Use Simplified Sewerage*. Water Science & Technology: Water Supply 5 (6): 57-65.
Available at: www.oieau.org/eaudoc/system/files/documents/41/205369/205369_doc.pdf
(An article summarizing the technology and its potential role in urban sanitation)
- _ Mara, D. D., Sleight, A. and Tayler, K. (2001). *PC-Based Simplified Sewer Design*. University of Leeds, Leeds, UK.
Available at: www.susana.org/_resources/documents/default/3-3012-7-1520342301.pdf
(Comprehensive coverage of theory and design including a program to be used as a design aid)
- _ Watson, G. (1995). *Good Sewers Cheap? Agency-Customer Interactions in Low-Cost Urban Sanitation in Brazil*. Water and Sanitation Division, The World Bank, Washington, D.C., US.
Available at: www.wsp.org/sites/wsp/files/publications/Good_sewer.pdf
(A summary of large-scale projects in Brazil)
- _ Instituto Nicaragüense de Acueductos y Alcantarillado - INAA, (2013). *Normativa Alcantarillado Condominial - Guía de Criterios Técnicos para el Diseño de Sistemas* (GAS-GCTD-01.V1-INAA-13), Nicaragua, Managua
Available at: www.inaa.gob.ni/node/223
- _ Instituto Nicaragüense de Acueductos y Alcantarillado (INAA, Ente Regulador) (2013). *Normativa Alcantarillado Condominial - Guía para la Movilización Técnica y Social* (GAS-GMTS-01.V2-INAA-13), Nicaragua, Managua

C.4

- _ Azevedo Netto, J. and Reid, R. (1992). *Innovative and Low-Cost Technologies Utilized in Sewerage*. Technical Series No. 29, Environmental Health Program, Pan American Health Organization, Washington, D.C., US.
(A short summary and component diagrams – Chapter 5)
- _ Crites, R. and Tchobanoglous, G. (1998). *Small and Decentralized Wastewater Management Systems*. WCB/McGraw-Hill, New York, US. pp. 355-364.
(A short summary of design and construction considerations)
- _ Mara, D. D. (1996a). *Low-Cost Sewerage*. Wiley, Chichester, UK. (Assessment of different low-cost systems and case studies)
- _ Mara, D. D. (1996b). *Low-Cost Urban Sanitation*. Wiley, Chichester, UK. pp. 93-108.
(Comprehensive summary including design examples)
- _ Otis, R. J. and Mara, D. D. (1985). *The Design of Small Bore Sewer Systems*. UNDP Interregional Project INT/81/047, The World Bank and UNDP, Washington, D.C., US.
Available at: <http://documents.worldbank.org/curated/en/home>

C.5

- _ Bizier, P. (Ed.) (2007). *Gravity Sanitary Sewer Design and Construction*. Second Edition. ASCE Manuals and Reports on Engineering Practice No. 60, WEF MOP No. FD-5. American Society of Civil Engineers, New York, US. (A standard design text used in North America, although local codes and standards should be assessed before choosing a design manual)
- _ Tchobanoglous, G. (1981). *Wastewater Engineering: Collection and Pumping of Wastewater*. McGraw-Hill, New York, US.
- _ U.S. EPA (2002). *Collection Systems Technology Fact Sheet*. Sewers, Conventional Gravity.832-F-02-007. U.S. Environmental Protection Agency, Washington, D.C., US. Available at: www.epa.gov
(Good description of the technology, including more detailed design criteria and information on operation and maintenance)

PRE

- Morel, A. and Diener, S. (2006). *Greywater Management in Low and Middle-Income Countries*. Review of Different Treatment Systems for Households or Neighbourhoods. Eawag (Department Sandec), Dübendorf, CH. Available at: www.sandec.ch
- Robbins, D. M. and Ligon, G.C. (2014). *How to Design Wastewater Systems for Local Conditions in Developing Countries*. IWA Publishing, London, UK. Available at doi: 10.2166/9781780404776
- Taylor, K. (2018). *Faecal Sludge and Septage Treatment: A guide for low- and middle-income countries*, Practical Action Publishing, Rugby, UK. Available at doi: 10.3362/9781780449869
- Tchobanoglous, G., Burton, F. L. and Stensel, H. D. (2004). *Wastewater Engineering: Treatment and Reuse, Metcalf & Eddy*, 4th Ed. (Internat. Ed.). McGraw-Hill, New York, US.
- Ulrich, A. (Ed.), Reuter, S. (Ed.), Gutterer, B. (Ed.), Sasse, L., Panzerbieter, T. and Reckerzügel, T. (2009). *Decentralised Wastewater Treatment Systems (DEWATS) and Sanitation in Developing Countries*. A Practical Guide. WEDC, Loughborough University, Leicestershire, UK. Available at: <https://wedc-knowledge.lboro.ac.uk/details.html?id=10409>

T.1

- EPA Ireland (1997). *Waste Water Treatment Manuals – Primary, Secondary and Tertiary Treatment*. Wexford, IE. Available at: www.epa.ie
- Taylor, K. (2018). *Faecal Sludge and Septage Treatment: A guide for low- and middle-income countries*, Practical Action Publishing, Reino Unido., Disponible en: <https://practicalactionpublishing.com/book/2541/tratamiento-de-lodos-fecales>
- Tchobanoglous, G., Burton, F. L. and Stensel, H. D. (2004). *Wastewater Engineering: Treatment and Reuse, Metcalf & Eddy*, 4th Ed. (Internat. Ed.). McGraw-Hill, New York, US.

T.2

- Alexandre, O., Boutin, C., Duchène, Ph., Lagrange, C., Lakel, A., Liénard, A. and Orditz, D. (1998). *Filières d'épuration adaptées aux petites collectivités*. Document technique FNDAE n°22, Cemagref, Lyon, FR. Available at: www.fnadae.fr
- Herrera, A. (2006). *Rehabilitation of the Imhoff Tank Treatment Plant in Las Vegas, Santa Barbara Honduras, Central America*. Master thesis, Department of Civil, Architectural and Environmental Engineering, University of Texas, Austin, US. (Case study providing general information about Imhoff tanks and insights into implementation and operational problems. Recommendations for O&M are provided.)
- McLean, R. C. (2009). *Honduras Wastewater Treatment: Chemically Enhanced Primary Treatment and Sustainable Secondary Treatment Technologies for Use with Imhoff Tanks*. Master thesis, Department of Civil and Environmental Engineering, Massachusetts Institute of Technology, Cambridge, US. (Case study including a detailed description of the functionality of the Imhoff tank)
- Ulrich, A. (Ed.), Reuter, S. (Ed.), Gutterer, B. (Ed.), Sasse, L., Panzerbieter, T. and Reckerzügel, T. (2009). *Decentralised Wastewater Treatment Systems (DEWATS) and Sanitation in Developing Countries*. A Practical Guide. WEDC, Loughborough University, Leicestershire, UK. Available at: <https://wedc-knowledge.lboro.ac.uk/details.html?id=10409> (Comprehensive handbook about planning and implementation of decentralized wastewater treatment options. It includes case studies and Excel spreadsheets for design calculations.)
- Taylor, K. (2018). *Faecal Sludge and Septage Treatment: A guide for low- and middle-income countries*, Practical Action Publishing, Reino Unido., Disponible en: <https://practicalactionpublishing.com/book/2541/tratamiento-de-lodos-fecales>
- WSP (Ed.) (2008). *Philippines Sanitation Sourcebook and Decision Aid*. Water and Sanitation Program, Washington, D.C., US. Available at: <http://documents.worldbank.org/curated/en/home> (Basic information about low-cost decentralized sanitation technologies for decision makers. Presents fact sheets about 23 selected options, including the Imhoff tank.)

T.3

- _ Bachmann, A., Beard, V. L. and McCarty, P. L. (1985). *Performance Characteristics of the Anaerobic Baffled Reactor*. Water Research 19 (1): 99-106.
- _ Barber, W. P. and Stuckey, D. C. (1999). *The Use of the Anaerobic Baffled Reactor (ABR) for Wastewater Treatment: A Review*. Water Research 33 (7): 1559-1578.
- _ Foxon, K. M., Buckley, C. A., Brouckaert, C. J., Dama, P., Mtembu, Z., Rodda, N., Smith, M., Pillay, S., Arjun, N., Lalbahadur, T. and Bux, F. (2006). *Evaluation of the Anaerobic Baffled Reactor for Sanitation in Dense Peri-urban Settlements*. WRC Report No 1248/01/06, Water Research Commission, Pretoria, ZA. Available at: www.wrc.org.za
- _ Foxon, K. M., Pillay, S., Lalbahadur, T., Rodda, N., Holder, F. and Buckley, C. A. (2004). *The Anaerobic Baffled Reactor (ABR): An Appropriate Technology for on-Site Sanitation*. Water SA 30 (5) (Special Edition). Available at: www.wrc.org.za
- _ Stuckey, D. C. (2010). *Anaerobic Baffled Reactor (ABR) for Wastewater Treatment*. In: Environmental Anaerobic Technology. Applications and New Developments, H. H. P. Fang (Ed.), Imperial College Press, London, UK.
- _ Tayler, K. (2018). *Faecal Sludge and Septage Treatment: A guide for low- and middle-income countries*, Practical Action Publishing, Reino Unido., Disponible en: <https://practicalactionpublishing.com/book/2541/tratamiento-de-lodos-fecales>
- _ Ulrich, A. (Ed.), Reuter, S. (Ed.), Gutterer, B. (Ed.), Sasse, L., Panzerbieter, T. and Reckerzügel, T. (2009). *Decentralised Wastewater Treatment Systems (DEWATS) and Sanitation in Developing Countries*. A Practical Guide. WEDC, Loughborough University, Leicestershire, UK. Available at: <https://wedc-knowledge.lboro.ac.uk/details.html?id=10409>

T.4

- _ Morel, A. and Diener, S. (2006). *Greywater Management in Low and Middle-Income Countries*. Review of Different Treatment Systems for Households or Neighbourhoods. Eawag (Department Sandec), Dübendorf, CH. Available at: www.sandec.ch (Short summary including case studies – p. 28)
- _ von Sperling, M. and de Lemos Chernicharo, C. A. (2005). *Biological Wastewater Treatment in Warm Climate Regions*, Volume One. IWA Publishing, London, UK. pp. 728-804. Available at doi: 10.2166/9781780402734 (Detailed design instructions)
- _ Tayler, K. (2018). *Faecal Sludge and Septage Treatment: A guide for low- and middle-income countries*, Practical Action Publishing, Rugby, UK. Available at doi: 10.3362/9781780449869
- _ Ulrich, A. (Ed.), Reuter, S. (Ed.), Gutterer, B. (Ed.), Sasse, L., Panzerbieter, T. and Reckerzügel, T. (2009). *Decentralised Wastewater Treatment Systems (DEWATS) and Sanitation in Developing Countries*. A Practical Guide. WEDC, Loughborough University, Leicestershire, UK. Available at: <https://wedc-knowledge.lboro.ac.uk/details.html?id=10409> (Design summary including Excel spreadsheets for design calculations)

T.5

- Kayombo, S., Mbwette, T. S. A., Katima, J. H. Y., Ladegaard, N. and Jorgensen, S. E. (2004). *Waste Stabilization Ponds and Constructed Wetlands Design Manual*. UNEP-IETC/Danida, Dar es Salaam, TZ/Copenhagen, DK. Available at: www.unep.org
- Pena Varón, M. and Mara, D. D. (2004). *Waste Stabilisation Ponds*. Thematic Overview Paper. IRC International Water and Sanitation Centre, Delft, NL. Available at: www.ircwash.org
- Shilton, A. (Ed.) (2005). *Pond Treatment Technology*. Integrated Environmental Technology Series, IWA Publishing, London, UK. Available at: www.iwapublishing.com
- Tayler, K. (2018). *Faecal Sludge and Septage Treatment: A guide for low- and middle-income countries*, Practical Action Publishing, Rugby, UK. Available at doi: 10.3362/9781780449869
- von Sperling, M. (2007). *Waste Stabilisation Ponds*. Biological Wastewater Treatment Series, Volume Three. IWA Publishing, London, UK. Available at: www.iwapublishing.com/books/book-series/biological-wastewater-treatment-series
- Ulrich, A. (Ed.), Reuter, S. (Ed.), Gutterer, B. (Ed.), Sasse, L., Panzerbieter, T. and Reckerzügel, T. (2009). *Decentralised Wastewater Treatment Systems (DEWATS) and Sanitation in Developing Countries*. A Practical Guide. WEDC, Loughborough University, Leicestershire, UK. Available at: <https://wedc-knowledge.lboro.ac.uk/details.html?id=10409> (Detailed description and Excel spreadsheets for design calculations)

T.6

- Tayler, K. (2018). *Faecal Sludge and Septage Treatment: A guide for low- and middle-income countries*, Practical Action Publishing, Rugby, UK. Available at doi: 10.3362/9781780449869
- Tchobanoglous, G., Burton, F. L. and Stensel, H. D. (2004). *Wastewater Engineering: Treatment and Reuse*, Metcalf & Eddy, 4th Ed. (Internat. Ed.). McGraw-Hill, New York, US. pp. 840-854. (Detailed design and example problems)

T.7

- Dotro, G., Langergraber, G., Molle, P., Nivala, J., Puigagut, J., Stein, O.R., von Sperling, M. (2017). *Treatment Wetlands*. Biological Wastewater Treatment Series, Volume 7, IWA Publishing, London, UK, eISBN: 9781780408774. Available at doi: 10.2166/9781780408774
- Kadlec, R. H. and Wallace, S. D. (2009). *Treatment Wetlands*, 2nd Ed. CRC Press, Taylor & Francis Group, Boca Raton, US.
- Langergraber, G., Dotro, G., Nivala, J., Rizzo, A., Stein, O.R.(Eds., 2019). *Wetland Technology: Practical information on the design and application of treatment wetlands*. IWA Scientific and Technical Report No.27, IWA Publishing, London, UK, ISBN13: 9781789060164. Available at doi: 10.2166/9781789060171
- Vymazal, J. (2008). *Constructed Wetlands for Wastewater Treatment: A Review*. In: Proceedings of Taal 2007: The 12th World Lake Conference, M. Sengupta and R. Dalwani (Eds.). pp. 965-980. Available at: www.moef.nic.in

T.8

- Dotro, G., Langergraber, G., Molle, P., Nivala, J., Puigagut, J., Stein, O.R., von Sperling, M. (2017). *Treatment Wetlands*. Biological Wastewater Treatment Series, Volume 7, IWA Publishing, London, UK, eISBN: 9781780408774. Available at doi: 10.2166/9781780408774
- Hoffmann, H., Platzer, C., Winker, M. and von Münch, E. (2011). *Technology Review of Constructed Wetlands. Subsurface Flow Constructed Wetlands for Greywater and Domestic Wastewater Treatment*. Gesellschaft für Internationale Zusammenarbeit (GIZ) GmbH, Eschborn, DE. Available at: www.susana.org/en/knowledge-hub/resources-and-publications/library/details/930

- _ Kadlec, R. H. and Wallace, S. D. (2009). *Treatment Wetlands*, 2nd Ed. CRC Press, Taylor & Francis Group, Boca Raton, US.
- _ Langergraber, G., Dotro, G., Nivala, J., Rizzo, A., Stein, O.R. (Eds., 2019). *Wetland Technology: Practical information on the design and application of treatment wetlands*. IWA Scientific and Technical Report No.27, IWA Publishing, London, UK, ISBN13: 9781789060164. Available at doi: 10.2166/9781789060171
- _ UN-HABITAT (2008). *Constructed Wetlands Manual*. UN-HABITAT Water for Asian Cities Programme. Kathmandu, NP. Available at: www.unhabitat.org
- _ Vymazal, J. Kröpfelová, L. (2008). *Wastewater Treatment in Constructed Wetlands with Horizontal Sub-Surface Flow*. Environmental Pollution book series, Volume 14, Springer Nature, Cham, CH, ISBN: 978-1-4020-8580-2.

T.9

- _ Dotro, G., Langergraber, G., Molle, P., Nivala, J., Puigagut, J., Stein, O.R., von Sperling, M. (2017). *Treatment Wetlands*. Biological Wastewater Treatment Series, Volume 7, IWA Publishing, London, UK, eISBN: 9781780408774. Available at doi: 10.2166/9781780408774
- _ Kadlec, R. H. and Wallace, S. D. (2009). *Treatment Wetlands*, 2nd Ed. CRC Press, Taylor & Francis Group, Boca Raton, US.
- _ Langergraber, G., Dotro, G., Nivala, J., Rizzo, A., Stein, O.R. (Eds., 2019). *Wetland Technology: Practical information on the design and application of treatment wetlands*. IWA Scientific and Technical Report No.27, IWA Publishing, London, UK, Available at doi: 10.2166/9781789060171
- _ Pucher, B., Langergraber, G. (2019). *Influence of design parameters on the treatment performance of VF wetlands – a simulation study*. *Water Sci Technol* 80(2), 265-273; Available at doi: 10.2166/wst.2019.268
- _ Stefanakis A., Akrotos C.S. and Tsihrintzis V.A. (2014). *Vertical Flow Constructed Wetlands -Eco-engineering Systems for Wastewater and Sludge Treatment*. Elsevier Science, Amsterdam, NL, ISBN 978-0-12-404612-2; Available at doi: 10.1016/C2012-0-01288-4
- _ UN-HABITAT (2008). *Constructed Wetlands Manual*. UN-HABITAT Water for Asian Cities Programme. Kathmandu, NP. Available at: www.unhabitat.org

T.10

- _ Cross, K. et al. (2021). *Nature-based Solutions for Wastewater Treatment*, IWA Publishing, pp. 251-252 Available at doi: 10.2166/9781789062267
- _ Eduardo Miguel (n.d.). *Natural Biological Treatment Systems: Aquatic Macrophyte Systems* Available at: [www.globalnature.org/bausteine.net/f/6460/EduardoMiguel-Filtrosverdes\(SriLanka\).pdf](http://www.globalnature.org/bausteine.net/f/6460/EduardoMiguel-Filtrosverdes(SriLanka).pdf)
- _ Global Nature Fund, Gattenlöhner, U. et al. (2019). *Filtros Verdes Latinoamérica* Available at: www.globalnature.org/bausteine.net/f/9134/FiltrosVerdes_Latinoamerica_2019.pdf
- _ Green Engineering (2021). *Filtros Verdes Flotantes – Como funciona?* Available at: <https://greengcorp.com/como-funciona>
- _ Headley T., Tondera K. (2019). *Floating treatment wetlands*. In: Langergraber, G., Dotro, G., Nivala, J., Rizzo A., Stein O. (editors). *Wetland Technology – Practical Information on the Design and Application of Treatment Wetlands*. IWA Publishing, London, UK, pp. 112-114. Available at doi: 10.2166/9781789060171
- _ Sepulveda (2019). *Sistemas de filtros verdes en flotación (SFVF)*. Available at: www.aguasresiduales.info/revista/reportajes/sistema-de-filtros-verdes-en-flotacion-sfvf-de-sepulveda
- _ Omiflo (2021). *We convert Wastewater in beautiful and functional spaces*. Available at: www.omiflo.com/how-it-works

T.11

- Tchobanoglous, G., Burton, F. L. and Stensel, H. D. (2004). *Wastewater Engineering: Treatment and Reuse*, Metcalf & Eddy, 4th Ed. (Internat. Ed.). McGraw-Hill, New York, US. pp. 890-930. (Detailed description and example calculations)
- Ulrich, A. (Ed.), Reuter, S. (Ed.), Gutterer, B. (Ed.), Sasse, L., Panzerbieter, T. and Reckerzügel, T. (2009). *Decentralised Wastewater Treatment Systems (DEWATS) and Sanitation in Developing Countries*. A Practical Guide. WEDC, Loughborough University, Leicestershire, UK. Available at: <https://wedc-knowledge.lboro.ac.uk/details.html?id=10409>
- U.S. EPA (2000). *Wastewater Technology Fact Sheet. Trickling Filters*. 832-F-00-014. U.S. Environmental Protection Agency, Washington, D.C., US. Available at: www.epa.gov (Design summary including tips for trouble shooting)

T.12

- Lettinga, G., Roersma, R. and Grin, P. (1983). *Anaerobic Treatment of Raw Domestic Sewage at Ambient Temperatures Using a Granular Bed UASB Reactor*. *Biotechnology and Bioengineering* 25 (7): 1701-1723. (The first paper describing the process)
- von Sperling, M. and de Lemos Chernicharo, C. A. (2005). *Biological Wastewater Treatment in Warm Climate Regions*, Volume One. IWA Publishing, London, UK. pp. 741-804. Available at doi: 10.2166/9781780402734 (Detailed design information)
- Tayler, K. (2018). *Faecal Sludge and Septage Treatment: A guide for low- and middle-income countries*, Practical Action Publishing, Rugby, UK. Available at doi: 10.3362/9781780449869
- Tchobanoglous, G., Burton, F. L. and Stensel, H. D. (2004). *Wastewater Engineering: Treatment and Reuse*, Metcalf & Eddy, 4th Ed. (Internat. Ed.). McGraw-Hill, New York, US. pp. 1005-1016. (Detailed description and design information)
- Vigneswaran, S., Balasuriya, B. L. N. and Viraraghavan, T. (1986). *Environmental Sanitation Reviews. Anaerobic Wastewater Treatment – Attached Growth and Sludge Blanket Process*. Environmental Sanitation Information Center, AIT, Bangkok, TH. Available at: www.ircwash.org/sites/default/files/341.2-86AN-2504.p (Good technical overview – Chapter 5)

T.13

- Ludwig, H. F. and Mohit, K. (2000). *Appropriate Technology for Municipal Sewerage/Excreta Management in Developing Countries, Thailand Case Study*. *The Environmentalist* 20 (3): 215-219. (Assessment of the appropriateness of activated sludge for Thailand)
- von Sperling, M. and de Lemos Chernicharo, C. A. (2005). *Biological Wastewater Treatment in Warm Climate Regions*, Volume Two. IWA Publishing, London, UK. Available at doi: 10.2166/9781780402703
- Tayler, K. (2018). *Faecal Sludge and Septage Treatment: A guide for low- and middle-income countries*, Practical Action Publishing, Rugby, UK. Available at doi: 10.3362/9781780449869
- Tchobanoglous, G., Burton, F. L. and Stensel, H. D. (2004). *Wastewater Engineering: Treatment and Reuse*, Metcalf & Eddy, 4th Ed. (Internat. Ed.). McGraw-Hill, New York, US. (Detailed design information)

T.14

- Strande, L., Ronteltap, M. and Brdjanovic, D. (Eds.) (2014). *Faecal Sludge Management. Systems Approach for Implementation and Operation*. IWA Publishing, London, UK. Available at: www.sandec.ch/fsm_book (Detailed book compiling the current state of knowledge on all aspects related to FSM)
- Tayler, K. (2018). *Faecal Sludge and Septage Treatment: A guide for low- and middle-income countries*, Practical Action Publishing, Rugby, UK. Available at doi: 10.3362/9781780449869

T.15

- Montangero, A. and Strauss, M. (2002). *Faecal Sludge Treatment*. Lecture Notes, UNESCO-IHE, Delft, NL. Available at: www.sandec.ch
- Strande, L., Ronteltap, M. and Brdjanovic, D. (Eds.) (2014). *Faecal Sludge Management. Systems Approach for Implementation and Operation*. IWA Publishing, London, UK. Available at: www.sandec.ch/fsm_book
(Detailed book compiling the current state of knowledge on all aspects related to FSM)
- Tayler, K. (2018). *Faecal Sludge and Septage Treatment: A guide for low- and middle-income countries*, Practical Action Publishing, Rugby, UK. Available at doi: 10.3362/ 9781780449869
- Tchobanoglous, G., Burton, F. L. and Stensel, H. D. (2004). *Wastewater Engineering: Treatment and Reuse*, Metcalf & Eddy, 4th Ed. (Internat. Ed.). McGraw-Hill, New York, US.

T.16

- Kengne Noumsi, I. M. (2008). *Potentials of Sludge Drying Beds Vegetated with *Cyperus papyrus* L. and *Echinochloa pyramidalis* (Lam.) Hitchc. & Chase for Faecal Sludge Treatment in Tropical Regions [PhD dissertation]*. University of Yaounde, Yaounde, CM. Available at: www.north-south.unibe.ch
- Koottatep, T., Surinkul, N., Polprasert, C., Kamal, A. S. M., Koné, D., Montangero, A., Heinss, U. and Strauss, M. (2005). *Treatment of Septage in Constructed Wetlands in Tropical Climate – Lessons Learnt after Seven Years of Operation*. *Water Science & Technology* 51 (9): 119-126. Available at: www.sandec.ch
- Strande, L., Ronteltap, M. and Brdjanovic, D. (Eds.) (2014). *Faecal Sludge Management. Systems Approach for Implementation and Operation*. IWA Publishing, London, UK. Available at: www.sandec.ch/fsm_book
(Detailed book compiling the current state of knowledge on all aspects related to FSM)
- Tayler, K. (2018). *Faecal Sludge and Septage Treatment: A guide for low- and middle-income countries*, Practical Action Publishing, Rugby, UK. Available at doi: 10.3362/9781780449869
- Tchobanoglous, G., Burton, F. L. and Stensel, H. D. (2004). *Wastewater Engineering: Treatment and Reuse*, Metcalf & Eddy, 4th Ed. (Internat. Ed.). McGraw-Hill, New York, US. p. 1578.

T.17

- Hoornweg, D., Thomas, L. and Otten, L. (2000). *Composting and Its Applicability in Developing Countries*. Urban Waste Management Working Paper Series No. 8. The World Bank, Washington, D.C., US. Available at: <https://documents.worldbank.org>
- Koné, D., Cofie, O., Zurbrügg, C., Gallizzi, K., Moser, D., Drescher, S. and Strauss, M. (2007). *Helminth Eggs Inactivation Efficiency by Faecal Sludge Dewatering and Co-Composting in Tropical Climates*. *Water Research* 41 (19): 4397-4402.
- Rouse, J., Rothenberger, S. and Zurbrügg, C. (2008). *Marketing Compost, a Guide for Compost Producers in Low and Middle-Income Countries*. Eawag (Department Sandec), Dübendorf, CH. Available at: www.sandec.ch
- Roman, P., Martinez, M. and Pantoja, A. (2013). *Manual de Compostaje del Agricultor*. Experiencias en America Latina. FAO, Rome Available at: www.fao.org/3/i3388s/i3388s.pdf
- Strande, L., Ronteltap, M. and Brdjanovic, D. (Eds.) (2014). *Faecal Sludge Management. Systems Approach for Implementation and Operation*. IWA Publishing, London, UK. Available at: www.sandec.ch
(Detailed book compiling the current state of knowledge on all aspects related to FSM)
- Tayler, K. (2018). *Faecal Sludge and Septage Treatment: A guide for low- and middle-income countries*, Practical Action Publishing, Rugby, UK. Available at doi: 10.3362/ 9781780449869

T.18

- _ CMS (1996). *Biogas Technology: A Training Manual for Extension*. FAO/TCP/NEP/4451-T. Consolidated Management Services, Kathmandu, NP. Available at: www.fao.org
- _ Mang, H.-P. and Li, Z. (2010). *Technology Review of Biogas Sanitation*. Draft – Biogas Sanitation for Blackwater, Brown Water, or for Excreta Treatment and Reuse in Developing Countries. Gesellschaft für Internationale Zusammenarbeit (GIZ) GmbH, Eschborn, DE. Available at: www.susana.org/en/knowledge-hub/resources-and-publications/library/details/877
- _ Ulrich, A. (Ed.), Reuter, S. (Ed.), Gutterer, B. (Ed.), Sasse, L., Panzerbieter, T. and Reckerzügel, T. (2009). *Decentralised Wastewater Treatment Systems (DEWATS) and Sanitation in Developing Countries*. A Practical Guide. WEDC, Loughborough University, Leicestershire, UK. Available at: <https://wedc-knowledge.lboro.ac.uk/details.html?id=10409>
- _ Tayler, K. (2018). *Faecal Sludge and Septage Treatment: A guide for low- and middle-income countries*, Practical Action Publishing, Rugby, UK. Available at doi: 10.3362/9781780449869
- _ Vögeli, Y., Lohri, C. R., Gallardo, A., Diener, S. and Zurbrügg, C. (2014). *Anaerobic Digestion of Biowaste in Developing Countries*. Practical Information and Case Studies. Eawag (Department Sandec), Dübendorf, CH. Available at: www.sandec.ch

T.19

- _ Bier, H., EBI Whitepaper (2020). *Biochar-based carbon sinks to mitigate climate change*. European Biochar Industry Consortium e.V. (EBI), Freiburg. Available at: www.biochar-industry.com/wp-content/uploads/2020/10/Whitepaper_Biochar2020.pdf
- _ Gold, M., Cunningham, M., Bleuler, M., Arnheiter, R., Schönborn, A., Niwagaba, C., & Strande, L. (2018). *Operating parameters for three resource recovery options from slow-pyrolysis of faecal sludge*. *Journal of Water, Sanitation and Hygiene for Development* 8(4), pp. 707–717. DOI: 10.2166/washdev.2018.009.
- _ Inguanzo, M., Dominguez, A., Menéndez, J. A., Blanco, C. G., & Pis, J. J. (2002). *On the pyrolysis of sewage sludge: the influence of pyrolysis conditions on solid, liquid and gas fractions*. *Journal of Analytical and Applied Pyrolysis*, 63, pp. 209–222. Available at doi: 10.1016/S0165-2370(01)00155-3
- _ Lehmann, J., & Joseph, S. (2009). *Biochar for Environmental Management- Science, Technology and Implementation*. 1st edition, Earthscan, London, UK. ISBN: 978-1-84407-658-1. Available at: www.researchgate.net/publication/204978620_On_the_pyrolysis_of_sewage_sludge_The_influence_of_pyrolysis_conditions_on_solid_liquid_and_gas_fractions
- _ Lewandowski, W. M., Ryms, M., & Kosakowski, W. (2020). *Thermal Biomass Conversion: A Review*. *Processes* 2020, 8(5), pp. 516; Available at doi: 10.3390/pr8050516
- _ Oaks, R. (2018). *Making Charcoal and Biochar*. A Comprehensive Guide. The Crowood Press Ltd Ramsbury, Marlborough, Wiltshire, England.
- _ Ok, Y.S., Uchimiya S.M., Chang, S.X., Bolan, N. Editors (2016). *Biochar, Production, Characterization and Applications*. CRC Press, Boca Raton, Florida.
- _ Scheub, U., Pieplow, H., Schmidt, H.-P., Draper, K. (2016). *Terra Preta*. Greystone Books, Vancouver, Berkeley.
- _ Wang, J., Xiong, Z., & Kuzyakov, Y. (2016). *Biochar Stability in Soil: Meta-Analysis of Decomposition and Priming Effects*. *GCB Bioenergy*, 8, 512-523. Available at: <https://onlinelibrary.wiley.com/doi/10.1111/gcbb.12266>

POST

- _ NWRI (2012). *Ultraviolet Disinfection. Guidelines for Drinking Water and Water Reuse*. 3rd Ed. National Water Research Institute and Water Research Foundation, Fountain Valley, CA, US. Available at: www.nwri-usa.org
- _ Robbins, D. M. and Ligon, G.C. (2014). *How to Design Wastewater Systems for Local Conditions in Developing Countries*. IWA Publishing, London, UK. Available at doi: 10.2166/9781780404776
- _ SSWM Toolbox. www.sswm.info/category/implementation-tools/water-purification (last accessed February 2014)
- _ Tayler, K. (2018). *Faecal Sludge and Septage Treatment: A guide for low- and middle-income countries*, Practical Action Publishing, Rugby, UK. Available at doi: 10.3362/9781780449869
- _ Tchobanoglous, G., Burton, F. L. and Stensel, H. D. (2004). *Wastewater Engineering: Treatment and Reuse*, Metcalf & Eddy, 4th Ed. (Internat. Ed.). McGraw-Hill, New York, US. pp. 1035-1330.
- _ WHO (2006). *Guidelines for the Safe Use of Wastewater, Excreta and Greywater*. Volume 2: Wastewater Use in Agriculture. World Health Organization, Geneva, CH. Available at: www.who.int

R.1

- _ von Münch, E. and Winker, M. (2011). *Technology Review of Urine Diversion Components*. Overview of Urine Diversion Components Such as Waterless Urinals, Urine Diversion Toilets, Urine Storage and Reuse Systems. Gesellschaft für Internationale Zusammenarbeit (GIZ) GmbH, Eschborn, DE. Available at: www.susana.org/en/knowledge-hub/resources-and-publications/library/details/875
- _ Rich Earth Institute (2022). *Fertilizer from Urine-Farming*. Rich Earth Institute News. Available at: <http://ricearthinstitute.org/rethinking-urine/farming/>
- _ Rich Earth Institute (2021). *Urine my Garden. A step-by-step guide to fertilizing with urine in home gardens*. Rich Earth Institute. Available at: http://ricearthinstitute.org/wp-content/uploads/2021/05/UrineMyGarden_DIYGuide.pdf
- _ RF AGRICULTURE (2020). *What is a Fertilizer Injector? Commercial Agriculture*. wholesaleagriculture.home.blog/2020/08/19/what-is-a-fertilizer-injector/ Available at: <https://wholesaleagriculture.home.blog/2020/08/19/what-is-a-fertilizer-injector/>
- _ Richert, A., Gensch, R., Jönsson, H., Stenström, T. A., and Dagerskog, L. (2010). *Practical Guidance on the Use of Urine in Crop Production*. EcoSanRes, Stockholm Environment Institute, Stockholm, SE. Available at: www.susana.org/library
- _ WHO (2006). *Guidelines for the Safe Use of Wastewater, Excreta and Greywater*. Volume 4: Excreta and Greywater Use in Agriculture. World Health Organization, Geneva, CH. Available at: www.who.int

R.2

- _ Roman, P., Martinez, M. and Pantoja, A., (2013). *Manual de Compostaje del Agricultor*. Experiencias en America Latina. FAO, Rome. Available at: www.fao.org/3/i3388s/i3388s.pdf
- _ Strande, L., Ronteltap, M. and Brdjanovic, D. (Eds.) (2014). *Faecal Sludge Management. Systems Approach for Implementation and Operation*. IWA Publishing, London, UK. Available at: www.sandec.ch/fsm_book (Detailed book compiling the current state of knowledge on all aspects related to FSM)
- _ The US Compost Council (2001). *Field Guide to Compost Use*. Edition, Bethesda, MD. Available at: www.mncompostingcouncil.org/uploads/1/5/6/0/15602762/fgcu.pdf
- _ WHO (2006). *Guidelines for the Safe Use of Wastewater, Excreta and Greywater*. Volume 4: Excreta and Greywater Use in Agriculture. World Health Organization, Geneva, CH. Available at: www.who.int

R.3

- _ Strande, L., Ronteltap, M. and Brdjanovic, D. (Eds.) (2014). *Faecal Sludge Management. Systems Approach for Implementation and Operation*. IWA Publishing, London, UK. Available at: www.sandec.ch/fsm_book (Detailed book compiling the current state of knowledge on all aspects related to FSM)
- _ U.S. EPA (1999). *Biosolids Generation, Use, and Disposal in the United States*. EPA-530/R-99-009. U.S. Environmental Protection Agency, Washington, D.C., US. Available at: www.epa.gov
- _ U.S. EPA (1994). *A Plain English Guide to the EPA Part 503 Biosolids Rule*. EPA832-R-93-003. U.S. Environmental Protection Agency, Washington, D.C., US. Available at: www.epa.gov
- _ WHO (2006). *Guidelines for the Safe Use of Wastewater, Excreta and Greywater*. Volume 4: Excreta and Greywater Use in Agriculture. World Health Organization, Geneva, CH. Available at: www.who.int

R.4

- _ Drechsel, P., Scott, C. A., Raschid-Sally, L., Redwood, M. and Bahri, A. (Eds.) (2010). *Wastewater Irrigation and Health. Assessing and Mitigating Risk in Low-Income Countries*. Earthscan, IDRC and IWMI, London, UK. Available at: www.idrc.ca and www.iwmi.cgiar.org
- _ FAO (2012). *On-Farm Practices for the Safe Use of Wastewater in Urban and Peri-Urban Horticulture*. Training Handbook for Farmer Field Schools. FAO, Rome, IT. Available at: www.fao.org
- _ Goyal, M.R., Editor (2015). *Sustainable Micro Irrigation*. Volume 1. Principles and Practices. CRC Press Taylor & Francis Group, Boca Raton, Florida, US.
- _ Goyal, M.R., Tripathi, V.K. Editors (2016). *Research Advances in Sustainable Micro Irrigation - Wastewater Management for Irrigation*. Volume 8. Principles and Practices. CRC Press Taylor & Francis Group, Boca Raton, Florida, US.
- _ Palada, M., Bhattarai, S., Wu, D., Roberts, M., Bhattarai, M., Kimsan, R. and Midmore, D. (2011). *More Crop Per Drop. Using Simple Drip Irrigation Systems for Small-Scale Vegetable Production*. The World Vegetable Center, Shanhua, TW. Available at: www.avrdc.org
- _ Pescod, M. B. (1992). *Wastewater Treatment and Use in Agriculture*. FAO Irrigation and Drainage Paper 47. FAO, Rome, IT. Available at: www.fao.org
- _ WHO (2006). *Guidelines for the Safe Use of Wastewater, Excreta and Greywater*. Volume 2: Wastewater Use in Agriculture. World Health Organization, Geneva, CH. (Discussion of health aspects of wastewater use and of good irrigation practice in Annex 1) Available at: www.who.int
- _ Winpenny, J., Heinz, I. and Koo-Oshima, S. (2010). *The Wealth of Waste. The Economics of Wastewater Use in Agriculture*. FAO Water Reports 35. FAO, Rome, IT. Available at: www.fao.org
- _ Zandee, M. (2012). *Risk of Clogging of Drip-Line Emitters during Urine Fertilization through Drip Irrigation Equipment*. Eawag, Dübendorf, CH. Available at: www.eawag.ch/stun

R.5

- _ Ahrens, B. (2005). *A Comparison of Wash Area and Soak Pit Construction: The Changing Nature of Urban, Rural, and Peri-Urban Linkages in Sikasso, Mali*. Peace Corps, US. Available at: www.mtu.edu/peacecorps/programs/civil/theses (Detailed construction instructions)
- _ Mara, D. (1996). *Low-Cost Urban Sanitation*. Wiley, Chichester, UK. pp. 63-65. (Dimensioning calculations) Oxfam (2008). *Septic Tank Guidelines*. Technical Brief. Oxfam GB, Oxford, UK. p. 4. Available at: www.policy-practice.oxfam.org.uk

- _ Polprasert, C. and Rajput, V. S. (1982). *Environmental Sanitation Reviews. Septic Tank and Septic Systems*. Environmental Sanitation Information Center, AIT, Bangkok, TH. pp. 31-58.
Available at: www.susana.org/_resources/documents/default/3-2995-7-1519811046.pdf

R.6

- _ Morel, A. and Diener, S. (2006). *Greywater Management in Low and Middle-Income Countries. Review of Different Treatment Systems for Households or Neighbourhoods*. Eawag (Department Sandec), Dübendorf, CH.
Available at: www.sandec.ch
- _ Polprasert, C. and Rajput, V. S. (1982). *Environmental Sanitation Reviews: Septic Tank and Septic Systems*. Environmental Sanitation Information Center, AIT, Bangkok, TH.
Available at: www.susana.org/_resources/documents/default/3-2995-7-1519811046.pdf
- _ Tayler, K. (2018). *Faecal Sludge and Septage Treatment: A guide for low- and middle-income countries*, Practical Action Publishing, Rugby, UK. Available at doi: 10.3362/9781780449869
- _ U.S. EPA (1980). *Design Manual. Onsite Wastewater Treatment and Disposal Systems*. EPA 625/1-80-012. U.S. Environmental

R.7

- _ Cross, P. and Strauss, M. (1985). *Health Aspects of Nightsoil and Sludge Use in Agriculture and Aquaculture*. International Reference Centre for Waste Disposal, Dübendorf, CH.
- _ Edwards, P. and Pullin, R. S. V. (Eds.) (1990). *Wastewater-Fed Aquaculture*. Proceedings: International Seminar on Wastewater Reclamation and Reuse for Aquaculture, Calcutta, IN. (Compilation of topical papers)
- _ Iqbal, S. (1999). *Duckweed Aquaculture. Potentials, Possibilities and Limitations for Combined Wastewater Treatment and Animal Feed Production in Developing Countries*. Eawag (Department Sandec), Dübendorf, CH.
Available at: www.sandec.ch
- _ Johnson Cointreau, S. (1987). *Aquaculture with Treated Wastewater: A Status Report on Studies Conducted in Lima, Peru*. Technical Note No. 3, Integrated Resource Recovery Project. The World Bank, Washington, D.C., US. 1987.
Available at: <https://documents.worldbank.org>
- _ Joint FAO/NACA/WHO Study Group (1999). *Food Safety Issues Associated with Products from Aquaculture*. WHO Technical Report Series 883. World Health Organization, Geneva, CH. Available at: www.who.int
- _ Mara, D. D. (2003). *Domestic Wastewater Treatment in Developing Countries*. Earthscan, London, UK. pp. 253-261.
- _ Rose, G. D. (1999). *Community-Based Technologies for Domestic Wastewater Treatment and Reuse: Options for Urban Agriculture*. International Development Research Centre (IDRC), Ottawa, CA.
Available at: www.susana.org/en/knowledge-hub/resources-and-publications/library/details/2997
- _ WHO (2006). *Guidelines for the Safe Use of Wastewater, Excreta and Greywater*. Volume 3: Wastewater and Excreta Use in Aquaculture. World Health Organization, Geneva, CH. Available at: www.who.int

R.8

- _ Iqbal, S. (1999). *Duckweed Aquaculture. Potentials, Possibilities and Limitations for Combined Wastewater Treatment and Animal Feed Production in Developing Countries*. Eawag (Department Sandec), Dübendorf, CH.
Available at: www.sandec.ch

- _ McDonald, R. D. and Wolverton, B. C. (1980). *Comparative Study of Wastewater Lagoon with and without Water Hyacinth*. *Economic Botany* 34 (2): 101-110.
- _ Reddy, K. R. and Smith, W. H. (Eds.) (1987). *Aquatic Plants for Water Treatment and Resource Recovery*. Magnolia Publishing Inc., Orlando, FL, US.
- _ Skillicorn, P., Spira, W. and Journey, W. (1993). *Duckweed Aquaculture. A New Aquatic Farming System for Developing Countries*. The World Bank, Washington, D.C., US. Available at: <https://documents.worldbank.org> (Comprehensive manual)
- _ Tayler, K. (2018). *Faecal Sludge and Septage Treatment: A guide for low- and middle-income countries*, Practical Action Publishing, Rugby, UK. Available at doi: 10.3362/9781780449869
- _ U.S. EPA (1988). *Design Manual. Constructed Wetlands and Aquatic Plant Systems for Municipal Water Treatment*. EPA/625/1-88/022. U.S. Environmental Protection Agency, Cincinnati, OH, US. Available at: www.epa.gov

R.9

- _ ARGOSS (2001). *Guidelines for Assessing the Risk to Groundwater from on-Site Sanitation*. British Geological Survey Commissioned Report, CR/01/142, Keyworth, UK. Available at: www.bgs.ac.uk
- _ Newcomer, M.E., Hubbard, S.S., Fleckenstein, J.H., Maier, U. Schmidt, C., Thullner, M., Ulrich, C., Flipo, Y.R. (2016). *Simulating bioclogging effects on dynamic riverbed permeability and infiltration*. In AGU Advances, Water Resources Research, Volume 52, Issue 4, Pages 2883-2900
Available at: <https://agupubs.onlinelibrary.wiley.com/doi/full/10.1002/2015WR018351>
- _ Seiler, K. P. and Gat, J. R. (2007). *Groundwater Recharge from Run-off, Infiltration and Percolation*. Springer, Dordrecht, NL
- _ Tchobanoglous, G., Burton, F. L. and Stensel, H. D. (2004). *Wastewater Engineering: Treatment and Reuse*, Metcalf & Eddy, 4th Ed. (Internat. Ed.). McGraw-Hill, New York, US
- _ WHO (2006). *Guidelines for the Safe Use of Wastewater, Excreta and Greywater*. Volume 3: Wastewater and Excreta Use in Aquaculture. World Health Organization, Geneva, CH Available at: www.who.int

R.10

- _ Strande, L., Ronteltap, M. and Brdjanovic, D. (Eds.) (2014). *Faecal Sludge Management. Systems Approach for Implementation and Operation*. IWA Publishing, London, UK. Available at: www.sandec.ch/fsm_book (Detailed book compiling the current state of knowledge on all aspects related to FSM)
- _ U.S. EPA (1999). *Biosolids Generation, Use, and Disposal in the United States*. EPA-530/R-99-009. U.S. Environmental Protection Agency, Washington, D.C., US. Available at: www.epa.gov
- _ U.S. EPA (1994). *A Plain English Guide to the EPA Part 503 Biosolids Rule*. EPA832-R-93-003. U.S. Environmental Protection Agency, Washington, D.C., US. Available at: www.epa.gov

R.11

- _ Deublein, D. and Steinhauser, A. (2011). *Biogas from Waste and Renewable Resources*, 2nd Ed. Wiley-VCH, Weinheim, DE.
- _ Kossmann, W., Pönitz, U., Habermehl, S., Hoerz, T., Krämer, P., Klingler, B., Kellner, C., Wittur, T., von Klopotek, F., Krieg, A. and Euler H. (1999). *Biogas Digest Volume II – Application and Product Development*. GTZ, Eschborn, DE.
Available at: www.susana.org/en/knowledge-hub/resources-and-publications/library/details/526
- _ Lohri, C. (2009). *Evaluation of Biogas Sanitation Systems in Nepalese Prisons*. Sandec News, 11, 20-21 Eawag (Department Sandec), Dübendorf and ICRC, Geneva, CH. Available at: www.sandec.ch

- _ Mang, H.-P. and Li, Z. (2010). *Technology Review of Biogas Sanitation. Draft – Biogas Sanitation for Blackwater, Brown Water, or for Excreta Treatment and Reuse in Developing Countries*. Gesellschaft für Internationale Zusammenarbeit (GIZ) GmbH, Eschborn, DE. Available at: www.susana.org/en/knowledge-hub/resources-and-publications/library/details/877
- _ Vögeli, Y., Lohri, C. R., Gallardo, A., Diener, S. and Zurbrügg, C. (2014). *Anaerobic Digestion of Biowaste in Developing Countries*. Practical Information and Case Studies. Eawag (Department Sandec), Dübendorf, CH. Available at: www.sandec.ch

R.12

- _ Bier, H., EBI Whitepaper (2020). *Biochar-based carbon sinks to mitigate climate change*. European Biochar Industry Consortium, Freiburg, Germany. Available at: www.biochar-industry.com/why/
- _ Buss, W., Bogush, A. Ignatyev, K., Masek, O. (2020). *Unlocking the fertilizer potential of waste derived biochar*. In ACS Sustainable Chem. Eng. 8, 12295-12335. Available at doi: 10.1021/acssuschemeng.0c04336
- _ European Biochar Industry Consortium (2022). *European Biochar Market Report 2021/2022*. European Biochar Industry Consortium. Freiburg. Germany. Available at: www.biochar-industry.com/market-overview-21-22/
- _ Kambo, H. S., & Dutta, A. (2015). *A comparative review of biochar and hydrochar in terms of production, physico-chemical properties and applications*. Renewable and Sustainable Energy Reviews, 45, pp. 359–378. Available at doi: 10.1016/j.rser.2015.01.050
- _ Kuzyakov, Y., Bogomolova, I., Glaser, B. (2014). *Biochar stability in soil: Decomposition during eight years and transformation as assessed by compound-specific 14C analysis*. Soil Biology & Biochemistry, Volume 70, March 2014, Pages 229-236 Soil Biology & Biochemistry. Available at: www.user.gwdg.de/~kuzyakov/SBB_2014_Kuzyakov_BC-BioChar-14C-CO2-Lipids-MB-BPCA.pdf
- _ Latawiec, A. E., Królczyk, J. B., Kuboń, M., Szwedziak, K., Drosik, A., Polańczyk, E., Grotkiewicz, K. & Strassburg, B. B. (2017). *Willingness to Adopt Biochar in Agriculture: The Producer's Perspective*. Sustainability, 9(4), 655. Available at doi: 10.3390/su9040655
- _ Nanda, S., Dalai, A. K., Berruti, F., & Kozinski, J. A. (2016). *Biochar as an Exceptional Bioresource for Energy, Agronomy, Carbon Sequestration, Activated Carbon and Specialty Materials*. Waste & Biomass Valorization, 7, pp. 201–235. Available at doi: 10.1007/s12649-015-9459-z
- _ Ok, Y.S., Uchimiyama S.M., Chang, S.X., Bolan, N. Editors (2016). *Biochar, Production, Characterization and Applications*. CRC Press, Boca Raton, Florida, US.
- _ Scheub, U., Pieplow, H., Schmidt, H.-P., Draper, K. (2016). *Terra Preta*. Greystone Books, Vancouver, Berkeley.
- _ Tomczyk, A., Sokołowska, Z., & Boguta, P. (2020). *Biochar physicochemical properties: pyrolysis temperature and feedstock kind effects*. Reviews in Environmental Science and Biotechnology, 19, pp. 191–215. Available at doi: 10.1007/s11157-020-09523-3

Emerging Technologies

- _ Bill & Melinda Gates Foundation's work on water, sanitation & hygiene; www.gatesfoundation.org/our-work/programs/global-growth-and-opportunity/water-sanitation-and-hygiene
- _ City Wide Inclusive Sanitation Global Initiative: www.worldbank.org/en/topic/sanitation/brief/citywide-inclusive-sanitation
- _ Sanitation and Hygiene Fund (formally Water Supply and Sanitation Collaborative Council, WSSCC): www.shfund.org
- _ Water Research Commission: www.wrc.org.za
- _ Sustainable Sanitation Alliance (SuSanA): www.susana.org
- _ Faecal Sludge Management Alliance (FSMA): www.fsm-alliance.org
- _ South African Sanitation Technology Enterprise Programme: www.sastep.org.za
- _ ANSI website “ISO Non-Sewered Sanitation Standards” on “Reinvented Toilet Technologies in Development”: <https://sanitation.ansi.org/RTTech>

Emerging Technologies: WeCo Autonomous Flush Toilet

- _ Cid, C., Hoffmann, M. R.: (2018). *Design, implementation, and improvements on an integrated electrochemical wastewater treatment and recycling system for onsite sanitation in the developing world*. In: 256th American Chemical Society National Meeting & Exposition, 19-23 August 2018, Boston, MA.
Available at: <https://resolver.caltech.edu/CaltechAUTHORS:20181109-153433840>
- _ CaltechAUTHORS (2022). *Design, implementation, and improvements on an integrated electrochemical wastewater treatment and recycling system for onsite sanitation in the developing world*.
Available at: <https://authors.library.caltech.edu/90811/>
- _ Hiolski, E. (2019). *The Toilet Gets a Makeover*. ACS Central Science, 5(8), 1303-1306.
Available at doi: 10.1021/acscentsci.9b00769
- _ Huang, X., Qu, Y., Cid, C. A., Finke, C., Hoffmann, M. R., Lim, K., & Jiang, S. C. (2016). *Electrochemical disinfection of toilet wastewater using wastewater electrolysis cell*. Water Research, 92, 164-172.
Available at doi: 10.1016/j.watres.2016.01.040
- _ Kumar Varigala, S., Hegarty-Craver, M., Krishnaswamy, S., Madhavan, P., Basil, M., Rosario, P., Raj, A., Barani, V., A. Cid, C., Grego, S., & Luetzgen, M. (2020). *Field testing of an onsite sanitation system on apartment building blackwater using biological treatment and electrochemical disinfection*. Environmental Science: Water Research & Technology, 6(5), 1400-1411.
Available at doi: 10.1039/C9EW01106D
- _ R. Hoffmann, M., Cho, K., Cid, C., & Yan, Q. (2014a, février 24). *Development of a Self-Contained, PV-Powered Domestic Toilet and Electrochemical Wastewater Treatment System Suitable for the Developing World*. 3rd Annual International Conference on Sustainable Energy and Environmental Sciences (SEES 2014). Annual International Conference on Sustainable Energy and Environmental Sciences. Available at: https://doi.org/10.5176/2251-189X_SEES14.27
- _ Zöllig, H. (2015). *Electrolysis for the Treatment of Stored Source-Separated Urine* (p. 163 p.) ETH Zurich.
Available at doi: 10.3929/ETHZ-A-010549050

Emerging Technologies: SASTEP Programme

- _ Water Research Commission (2020). *SASTEP - Reinvented Toilet Technology Portfolio*, Department of Science & Technology, Republic of South Africa. Available at: www.sastep.org.za/wp-content/uploads/2020/07/SASTEP-RTT-Portfolio.pdf
- _ Water Research Commission (2020). *SASTEP - Local Sanitation Technology Portfolio*, Department of Science & Technology, Republic of South Africa.
Available at: www.sastep.org.za/wp-content/uploads/2020/07/SASTEP-Local-Technology-Portfolio.pdf
- _ Sindall, R.C., Cottingham, R.S., Sutherland, C., Mercer, S., Pocock, J., Arumugam-Nanoalal, P., Dhlamini, S., Magwaza, F., Shoji, M., Odili, A & Reddy, M. (2020). *Field-testing and Demonstration of Sanitation Technologies: Guidelines for the South African Sanitation Technology Enterprise Programme (SASTEP)*.
Available at: <https://gatesopenresearch.org/documents/5-67>
- _ Etter, B., Udert, K.M., Gounden, T., (2015). *Valorisation of Urine Nutrients. Promoting Sanitation & Nutrient Recovery through Urine Separation*. VUNA Final Report. Eawag, Dübendorf, Switzerland
Available at: www.eawag.ch/en/departement/eng/projects/vuna/
- _ Still, D., Bhagwan, J., Harris, J., (2014). *Pour Flush Sanitation. The Future or a 'Flash' in the Pan?*, Presentation at the WISA Biennial Conference, Nelspruit, South Africa
Available at: www.susana.org/_resources/documents/default/2-2033-2-pourflushatwisanelspruit20142.pdf
- _ Bhagwan, J., (2014). *The WRC Pour Flush Toilet*. Lessons from Western Cape Trials, Water Information Network South Africa, Lessons Series 2014, Water Research Commission, Pretoria, South Africa
Available at: www.wrc.org.za/wp-content/uploads/mdocs/Pour%20Flush%20Western%20Cape-lesson.pdf

Emerging Technologies: Zyclone Cube, Thailand

- _ Koottatep, K., Chapagain, S.K., Polprasert, C., Panuvatvanich, A., Ahn, K-H. (2016). *Sanitation situations in selected Southeast Asian countries and application of innovative technologies*. Springer, Dordrecht, NL
Available at doi: 10.1007/s10668-016-9892-6 and www.fsmttoolbox.com/assets/pdf/75.pdf
- _ Information and factsheets on “Reinvented Toilet Technologies in Development” on the website American National Standard Institute’s website dedicated to “ISO Non-Sewered Sanitation Standards” (e.g. Clear Recirculating Toilet, Zyclone Cube)
Available at: <https://sanitation.ansi.org/RTTech>

Part 3 Cross-Cutting Issues for Planning and Decision Making

- _ CWWA (2019). *Regional Strategic Action Plan (RSAP) for Governance and Building Climate Resilience in the Water Sector in the Caribbean*. Caribbean Water and Wastewater Association. Trinidad and Tobago.
Available at: <https://cwwa.net/publication/regional-strategic-action-plan-for-governance-and-building-climate-resilience-in-the-water-sector-in-the-caribbean/>
- _ CWWA (2019). Declaration of Basseterre, 15th High-Level Forum For Caribbean Ministers Responsible for Water, Basseterre, Saint Kitts And Nevis, October 14-15 2019
Available at: https://es.unesco.org/sites/default/files/final_signed_ministerial_declaration_-_st._kitts_and_nevis.pdf
- _ CWWA (2019). *Regional Strategic Action Plan for the Water Sector in the Caribbean to Develop Resilience to the Impacts of Climate Change. First Implementation Plan. Regional Level Responses*. Caribbean Water and Wastewater Association. Trinidad and Tobago. Available at: <https://cwwa.net/publication/regional-strategic-action-plan-for-the-water-sector-in-the-caribbean-to-develop-resilience-to-the-impacts-of-climate-change-first-implementation-plan-2019/>.
- _ CWWA (2021). *Regional Strategic Action Plan for the Water Sector in the Caribbean to Develop Resilience to the Impacts of Climate Change. Second Implementation Plan. Regional Level Responses, IP-2021 (Version 2, August 2021)*. Caribbean Water and Wastewater Association. Trinidad and Tobago.
- _ CWWA (2018). *Climate Change and the Water Sector in the Caribbean*, Video for the 8th World Water Forum, Brazil, with support from IDB, CDB, UNEP, and PAHO
Available at: https://youtu.be/Tp9Yd9_p3Gg (15min, last accessed February 2022)
- _ Fletcher, J. (2018). *Caribbean/Executive Summary*. Regional Process of The Americas, Sub-regional Report. World Water Forum 2018. Brazil. Brasilia. CWWA, IDB, CDB
Available at: <http://dx.doi.org/10.18235/0001029>
- _ K&M Advisors (2019). *Governance Position Paper on the Caribbean Water and Sanitation Sector, Final Report and Action Plan*. Inter-American Development Bank.
Available at: <https://clmplus.org/doculibrary/governance-position-paper-on-the-caribbean-water-and-sanitation-sector/>

XA

Stakeholder Engagement

- _ Contributions of the World Water Forum 2015 to the United Nations High-Level Political Forum (HLPF) on Sustainable Development (2016). Available at: <https://sustainabledevelopment.un.org/index.php?page=view&type=30022&nr=88&menu=3170>
- _ Grupo Sarar (2012). *SARAR a methodology*. <https://youtu.be/6KZmzA6uF-M>
- _ Sawyer, R., Wood, S., Simpson-Hebert, M. (1998). *PHAST Step-by-step Guide: A participatory approach for the control of diarrheal disease* – Participatory Hygiene and Sanitation Transformation Series, World Health Organization WHO/Geneva (WHO/EOS/98.3). Available at: www.who.int/water_sanitation_health/publications/phastep/en
- _ SIWI (2021). *Indigenous Peoples and Water*. Official Website Topic. Stockholm International Water Institute. Stockholm. Sweden. Available at: <https://siwi.org/why-water/indigenous-knowledge/> (last accessed February 2022)

- _ Srinivasan, L. (1990). *Tools for Community Participation: A manual for training trainers in participatory techniques*. Available at: www.ircwash.org/sites/default/files/205.1-90TO-7275-1.pdf
- _ UNESCO (2006). *Water and Indigenous Peoples*. Edited by R. Boelens, M. Chiba and D. Nakashima. *Knowledges of Nature 2*, UNESCO: Paris, 177 pp. Available at: <https://unesdoc.unesco.org/ark:/48223/pf0000145353>
- _ UN Human Rights Council (2021). A/HRC/RES/48/13: *The human right to a clean, healthy and sustainable environment*. Available at: <https://documents-dds-ny.un.org/doc/UNDOC/GEN/G21/289/50/PDF/G2128950.pdf>

X B**Gender Sensitivity**

- _ Gensch, R., Jennings, A., Renggli, S., Reymond, P. (2018). *Compendium of Sanitation Technologies in Emergencies*. German WASH Network, Swiss Federal Institute of Aquatic Science and Technology, Global WASH Cluster and Sustainable Sanitation Alliance. Berlin. Germany. Available at: www.emersan-compendium.org/en/
- _ Kohler, P. (2016). *The need for gender sensitive planning in sanitation*. In: Gutterer, B., Reuter, S. (Eds.) *Key Elements for a New Urban Agenda – Integrated Management of Urban Waters and Sanitation* (2015 Conference Report), Bremen Overseas Research and Development Association, Bremen, Germany
Available at: www.susana.org/en/knowledge-hub/resources-and-publications/library/details/2611
- _ Masgon, M.A, Gensch, R. (2010). *Factsheet Water, Sanitation and Gender*. Sustainable Sanitation and Water Management Toolbox. Available at: <https://sswm.info/arctic-wash/module-1-introduction/further-resources-sustainability-relation-water-sanitation>

X C**Climate Resilience**

- _ IPCC (2022). *Summary for Policymakers*. In: *Climate Change 2022: Impacts, Adaptation, and Vulnerability*. Contribution of Working Group II to the Sixth Assessment Report of the Intergovernmental Panel on Climate Change. Cambridge, UK, University Press. Available at: https://report.ipcc.ch/ar6wg2/pdf/IPCC_AR6_WGII_SummaryForPolicymakers.pdf

X C.1 The International Discourse on Climate Change and Resilience in the Sanitation Sector

- _ Mikhael, G., Hyde-Smith, L., Twyman, B., Trancón, D.S., Jabagi, E., Bamford, E. (2021). *Climate Resilient Urban Sanitation – Accelerating the Convergence of Sanitation and Climate Action*. Deutsche Gesellschaft für Internationale Zusammenarbeit (GIZ) GmbH. Eschborn. Germany. Available at: www.susana.org/en/knowledge-hub/resources-and-publications/library/details/4343
- _ Gensch, R., Jennings, A., Renggli, S., Reymond, P. (2018). *Compendium of Sanitation Technologies in Emergencies*. German WASH Network, Swiss Federal Institute of Aquatic Science and Technology, Global WASH Cluster, Sustainable Sanitation Alliance. Berlin. Germany. Available at: www.emersan-compendium.org/en/
- _ Arup. (2019). *The City Water Resilience Approach*. Leeds: Arup, The Rockefeller Foundation, The Resilient Shift, SIWI.
Available at: www.arup.com/perspectives/publications/research/section/the-city-water-resilience-approach
- _ United Nations General Assembly A/RES/71/256* (2016). *New Urban Agenda*.
Available at: <https://habitat3.org/the-new-urban-agenda/>
- _ United Nations Human Settlements Programme (UN-Habitat). (2020). *New Urban Agenda Illustrated*. UN-Habitat. Nairobi. Kenya. Available at: <https://unhabitat.org/the-new-urban-agenda-illustrated>

X C.2 Co-Benefits for Better Resilience with Nature-Based Solutions

- _ Cohen-Shacham, E., Walters, G., Janzen, C. and Maginnis, S. (eds.). (2016). *Nature-Based Solutions to Address Global Societal Challenges*. International Union for Conservation of Nature and Natural Resources (IUCN). Gland, Switzerland.
Available at: <https://portals.iucn.org/library/node/46191>
- _ Cross, K., Tondera, K., Rizzo, A., Andrews, L., Pucher, B., Istenič, D., Karres, N., McDonald, R. (Eds.) (2021). *Nature-Based Solutions for Wastewater Treatment – A Series of Factsheets and Case Studies*. (344p), IWA Publishing. London. UK.
Available at doi: 10.2166/9781789062267

- _ Cayetano, E. (2020). *The Caribbean has a plan for securing water resources in the face of climate change*. Copyright © Inter-American Development Bank (“IDB”). Licensed under (CC-IGO 3.0 BY-NC-ND). Available at: <https://blogs.iadb.org/agua/en/the-caribbean-has-a-plan-for-securing-water-resources-in-the-face-of-climate-change/> (last accessed February 2022)

X 1.1 Institutional and Regulatory Environment

- _ Bos, R., Alves, D., Latorre, C., Macleod, N., Payen, G., Roaf, V., Rouse, M. (2016). *Manual in the Human Rights to Safe Drinking Water and Sanitation for Practitioners*. IWA Publishing. London. UK. Available at: www.iwapublishing.com/sites/default/files/ebooks/Bos_0.pdf
- _ Reuter, S (2019), based on Moss, J. (AquaFed, 2015), Links in the Sanitation Services Chain. 5th International Faecal Sludge Management Conference. Cape Town. South Africa. Available at: https://fsm5.susana.org/images/FSM_Conference_Materials/Wednesday/Afternoon_Plenary/1_180813_BORDA_WaterServiceChain.pdf

X 1.2 Working with Existing Standards and Guidelines

X 1.2.1 Protocol concerning Pollution from Land-Based Sources and Activities to the Cartagena Convention (LBS-Protocol)

- _ United Nations Environment Programme (1999). *Protocol Concerning Pollution from Land-based Sources and Activities to the Convention for the Protection and Development of the Marine Environment of the Wider Caribbean Region*. Available at: https://wedocs.unep.org/bitstream/handle/20.500.11822/34544/LBS_Protocol-en.pdf
- _ United Nations Environment Programme (2019). *State Of the Cartagena Convention Area (SOCAR): An Assessment of Marine Pollution from Land-Based Sources and Activities in the Wider Caribbean Region*. Available at: <https://wedocs.unep.org/20.500.11822/36346>.
- _ Talaue McManus, L., Heileman S., Corbin, C., Banjoo, D. (2021). *Regional Nutrient Pollution Reduction Strategy and Action Plan for the Wider Caribbean Region*. UNEP/Caribbean Environmental Programme. Available at: <http://gefcrew.org/carrcu/19IGM/LBSCOP5/Info-Docs/WG.41INF.10Rev.1-en.pdf>
- _ Sealy, H. (2021). *Technical Paper on Proposed Criteria for Nutrients Discharges for Domestic Wastewater Effluent*, CERMES/ University of the West Indies, Faculty of Science and Technology, Barbados. Available at: <http://gefcrew.org/carrcu/LBSSTAC5/Info-Docs/WG.41-INF.23-en.pdf>

X 1.2.2 ISO Standards for Sanitation Systems and Technologies of this Compendium

- _ Velkushanova, K., Jingxi, Z. (2020). *Workshop Training*. SANS/ISO:30500 Supporting Material: Booklet for participants. Pollution Research Group. University KwaZulu-Natal. eThekweni. South Africa. Available at: <https://sanitation.ansi.org/pdfs/ISO-30500-Participant-training-booklet-WRC.pdf>

The following standards are available along with additional information and updates on the ANSI website: <https://sanitation.ansi.org>

- _ ISO (2007). ISO 24510. *Activities relating to drinking water and wastewater services – Guidelines for the assessment and for the improvement of the service to users*. Switzerland: ISO.
- _ ISO (2007). ISO 24511. *Guidelines for the management of wastewater utilities and for the assessment of wastewater services*. Switzerland: ISO.
- _ ISO (2016). ISO 24521. *Guidelines for the management of basic on-site domestic wastewater services*. Switzerland: ISO.
- _ ISO (2018). ISO 30500. *Non-sewered sanitation systems – Prefabricated integrated treatment units– General safety and performance requirements for design and testing*. Switzerland: ISO.
- _ ISO (2020). ISO 31800. *Faecal sludge treatment units – Energy independent, prefabricated, community-scale, resource recovery units – Safety and performance requirements*. Switzerland: ISO.

X 1.2.3 Guidelines and Certification Process for Sustainable Biochar Production and Biochar Based Carbon Sinks

- _ EBC (2012-2022). *European Biochar Certificate - Guidelines for a Sustainable Production of Biochar*. Version 10.1 from 10th Jan 2022. European Biochar Foundation (EBC). Arbaz, Switzerland. Available at: <http://european-biochar.org>
- _ EBC (2020). *Certification of the carbon sink potential of biochar*. Version 2.1E of 1st February 2021. Ithaka Institute, Arbaz, Switzerland. Available at: <http://european-biochar.org>

X 2

Climate-Resilient Water Resource Management

X 2.1 Integrated Sanitation and Groundwater Assessment

- _ Wolf, L., Vilholth, K., Peal, A. (2022). *Integrated management of sanitation systems and protection of groundwater – critical to achieve the SDGs*, SuSanA-WG11 Thematic Paper. Available at: www.susana.org
- _ Clemens, M., Khurelbaatar, G., Merz, R., Siebert, C., van Afferden, M. and Ridiger, T. (2020). *Groundwater protection under water scarcity; from regional risk assessment to local wastewater treatment solutions in Jordan*. *Science of The Total Environment* 706, 136066. Available at doi: 10.1016/j.scitotenv.2019.136066
- _ Daus, A. (2019). *Aquifer Storage and Recovery: Improving Water Supply Security in the Caribbean Opportunities and Challenges*, Discussion Paper N IDB-DP-00712 Available at: <https://publications.iadb.org/en>
- _ Post, V.E.A., M. Eichholz, R. Brentführer (2018). *Groundwater management in coastal zones*. Bundesanstalt für Geowissenschaften und Rohstoffe (BGR). Hannover, Germany, 107 pp. Available at: www.bgr.bund.de/EN/Themen/Wasser/Aktuelles/Archiv/2018-09_gw-management-coastal-zones_en.html
- _ Gensch, R., Jennings, A., Renggli, S., Reymond, P. (2018). *Compendium of Sanitation Technologies in Emergencies*. German WASH Network Eawag, Global WASH Cluster and Sustainable Sanitation Alliance. Berlin, Germany. Available at: www.emersan-compendium.org/en/
- _ Wolf, L., Nick, A., Cronin, A. (2015). *How to keep your groundwater drinkable: Safer siting of sanitation systems*, Sustainable Sanitation Alliance (SuSanA). Available at: www.susana.org
- _ Guppy, L., Uyttendaele, P., Villholth, K. G., Smakhtin, V. (2018). *Groundwater and Sustainable Development Goals: Analysis Of Interlinkages*. UNU-INWEH Report Series, Issue 04. United Nations University Institute for Water, Environment and Health, Hamilton, Canada. Available at: <http://inweh.unu.edu/publications/>
- _ Jakeman, A. et al. (Ed.), (2016). *Integrated Groundwater Management – Concepts, Approaches and Challenges*, Springer Nature. Switzerland. Available at doi: 10.1007/978-3-319-23576-9_16

X 2.2 Managed Aquifer Recharge and Aquifer Storage and Recovery

- _ Coerver, A., Ewers, L., Fewster, E., Galbraith, D., Gensch, R., Matta, J., Peter, M. (2021). *Compendium of Water Supply Technologies in Emergencies*. German WASH Network, University of Applied Sciences and Arts Northwestern Switzerland, Global WASH Cluster and Sustainable Sanitation Alliance. Berlin. Germany. Available at: www.washnet.de/en/publications/emewater-compendium-2/
- _ EPA (2021). *Aquifer Recharge and Aquifer Storage and Recovery*. Official Website. Environmental Topics. United States Environmental Protection Agency. US. Available at: www.epa.gov/uic/aquifer-recharge-and-aquifer-storage-and-recovery (last accessed February 2022)
- _ GWP Consulting (2010). *Managed Aquifer Recharge (Mar): Practical Techniques for The Caribbean*, Caribbean Environmental Health Institute (CEHI), the Antigua Public Utilities Authority (APUA), the United Nations Environment Programme (UNEP), and GWP Consultants. Available at: www.caribbeanrainwaterharvestingtoolbox.com

X 2.3 Rainwater Harvesting

- Coerver, A., Ewers, L., Fewster, E., Galbraith, D., Gensch, R., Matta, J., Peter, M. (2021). *Compendium of Water Supply Technologies in Emergencies*. German WASH Network, University of Applied Sciences and Arts Northwestern Switzerland, Global WASH Cluster and Sustainable Sanitation Alliance. Berlin. Germany.
Available at: www.washnet.de/en/publications/emerwater-compendium-2/
- Global Water Partnership-Caribbean (GWP-C), including outputs produced under the “Regional Programme for the Promotion of Rainwater Harvesting in the Caribbean” undertaken by UNEP and the Caribbean Environmental Health Institute (CEHI)

X 3

Climate-Informed Decision Support

- Johnstone, D. W. M., Horan, N. J. (1996). *Institutional Developments, Standards and River Quality: A UK History and some Lessons for Industrialising Countries*, Water Science & Technology Vol. 33, No. 3, pp. 211-222, London, UK.
Available at: <https://doi.org/10.2166/wst.1996.0072>
- Northover, H. (2016). *How did the East Asian Tigers deliver sanitation within a generation?* In: Gutterer, B., Reuter, S. (Eds.) Key Elements for a New Urban Agenda – Integrated Management of Urban Waters and Sanitation (2015 Conference Report), Bremen Overseas Research and Development Association, Bremen, Germany
Available at: www.susana.org/en/knowledge-hub/resources-and-publications/library/details/2611
- Northover, H., Ryu, S. K., Brewer, T. (2016). *Achieving total sanitation and hygiene coverage within a generation – lessons from East Asia*, WaterAid, London. UK.
Available at: www.susana.org/en/knowledge-hub/resources-and-publications/library/details/2453
- UN Habitat and WHO (2021). *Progress on wastewater treatment – Global status and acceleration needs for SDG indicator 6.3.1*. United Nations Human Settlements Programme (UN-Habitat) and World Health Organization (WHO), Geneva.
Available at: www.unwater.org/publications/progress-on-wastewater-treatment-631-2021-update/

X 4

Climate-Resilient Water and Sanitation Services Provision

X 4.1 Planning Principles for Sanitation Systems

- Janson N., Burkhard, L.S., Jones, S. Eds. Cayetano, E.S., Cathala, C. (2021). *Caribbean Water Study*. Inter-American Development Bank (IDB Technical Note; 2320)
Available at: <http://dx.doi.org/10.18235/0003755>
- Gambrill et al. (2020). *Citywide Inclusive Sanitation—Business as Unusual: Shifting the Paradigm by Shifting Minds*. Front. Environ. Sci. Available at doi: 10.3389/fenvs.2019.00201
- Kennedy-Walker, Ruth, Nishtha Mehta, Seema Thomas, and Martin Gambrill. (2020). *Connecting the Unconnected: Approaches for Getting Households to Connect to Sewerage Networks*. World Bank, Washington, DC.
Available at: <http://hdl.handle.net/10986/34791>
- Observatory for Latin America and the Caribbean on Water and Sanitation (OLAS).
Available at: www.olasdata.org/en/
- Sparkman D. (2016). *Why business as usual will not achieve SDG6 in LAC: the promise of wastewater reuse, green infrastructure and small business around WASH: conclusions from World Water Week 2016*
Available at: <https://publications.iadb.org>
- Sustainable Sanitation Alliance (2017). SuSanA Vision Document
Available at: www.susana.org
- Odindo, A.O., Bame, I.B., Musazura, W., Hughes, J.C., and Buckley, C.A. (2016). *Integrating Agriculture in Designing On-Site, Low Cost Sanitation Technologies In Social Housing Schemes*. WRC Report No. TT 700/16, Tshwane, South Africa.
Available at: www.wrc.org.za/wp-content/uploads/mdocs/TT%20700-18.pdf

X 4.2 Costing Principles for Sanitation Systems

- Andersson, K., Rosemarin, A., Lamizana, B., Kvarnström, E., McConville, J., Seidu, R., Dickin, S. and Trimmer, C. (2020). *Sanitation, Wastewater Management and Sustainability: from Waste Disposal to Resource Recovery*. 2nd edition. Nairobi and Stockholm: United Nations Environment Programme and Stockholm Environment Institute.
Available at: www.sei.org/publications/sanitation-wastewater-management-and-sustainability/
- Kenton, W. and Kindness, D. (2020). *Equivalent Annual Cost – EAC Definition*. Investopedia Online Article. Dotdash Meredith Publishing. Available at: www.investopedia.com/terms/e/eac.asp (last accessed February 2022)
(Methodology and examples, also used for calculating the EAC of Case 6 in Part 4 of this Compendium)
- GWSP (Beta, 2018). *CWIS Costing and Planning Tool*. Global Water Security & Sanitation Partnership (GWSP). The World Bank.
Available at: www.cwiscostingtool.com
- Heredia, G., Saavedra, O., Rojas, I. (2020). *Evaluation of the annual equivalent cost (AEC) of wastewater treatment plants in the municipalities of Cliza and Tolata*. *Revista Investigación & Desarrollo*, Vol. 19 No.2 (2019).
Available at doi: 10.23881/idupbo.019.2-5e (Article is in Spanish).

X 4.3 Other Key Areas of Environmental Sanitation

- Narayan, A.S., Marks, S.J., Meierhofer, R., Strande, L., Tilley, E., Zurbrügg, C., Lüthi, C. (2021). *Advancements in and Integration of Water, Sanitation, and Solid Waste for Low- and Middle-Income Countries*. *Annu. Rev. Environ. Resour.*2021.46:193:219. Available at: <https://doi.org/10.1146/annurev-environ-030620-042304>
- Valcourt, N., Javernick-Will, A., Walters, J., Linden, K. (2020). *System approaches to water, sanitation, and hygiene: a systematic literature review*. *Int. J. Environ. Res. Public Health* 17(3):1702.
Available at doi: 10.3390/ijerph17030702
- Scott, R., Scott, P., Hawkins, P., Blackett, I., Cotton, A., Lerebours, A. (2019). *Integrating basic urban services for better sanitation outcomes*. *Sustainability* 11(23):6706. Available at doi: 10.3390/su11236706
- Morel, A., Diener, S. (2006). *Greywater Management in Low and Middle-Income Countries. Review of Different Treatment Systems for Households or Neighbourhoods*. Swiss Federal Institute for Aquatic Science and Technology (Eawag). Sandec Report: Vol. 14/06. Dübendorf, Switzerland.
Available at: www.susana.org/_resources/documents/default/2-947-en-greywater-management-2006.pdf
- De Jong, D. (2003). *Advocacy for water, environmental sanitation and hygiene - thematic overview paper*. WASH Working Paper. IRC International Water and Sanitation Centre. Delft. Netherlands.
Available at: www.ircwash.org/sites/default/files/Jong-2003-Advocacy.pdf

X 4.4 Operation & Effective Asset Management

- ISO (2016). ISO 24521. *Guidelines for the management of basic on-site domestic wastewater services*. Switzerland: ISO.
Available at: <https://sanitation.ansi.org>
- Mikhael, G., Hyde-Smith, L., Twyman, B., Trancón, D. S., Jabagi, E., Bamford, E. (2021). *Climate Resilient Urban Sanitation - Accelerating the Convergence of Sanitation and Climate Action*. Deutsche Gesellschaft für Internationale Zusammenarbeit (GIZ) GmbH. Eschborn. Germany.
Available at: www.susana.org/en/knowledge-hub/resources-and-publications/library/details/4343
- SuSanA (2012). *Operation and maintenance of sustainable sanitation systems*. Factsheet of Working Group 10. Sustainable Sanitation Alliance (SuSanA).
Available at: www.susana.org/en/knowledge-hub/resources-and-publications/library/details/939

X 4.5 Climate-Sensitive Sanitation Financing

- IDB (2021). *Water and Sanitation Sector Framework Document*. Inter-American Development Bank (IDB).

Part 4 Case 1 (Penonome, Panama)

- _ Green Engineering Corp. *Information on the Treatment Technology*. Available at: <https://greengcorp.com/como-funciona/> (last accessed February 2022)
- _ Executive Decree No. 150 (June 16th, 2020). *Update of the National Regulation of Urbanizations and Parcelling throughout the Territory of the Republic of Panama* (p. 28). Republic of Panama. Available at: www.gacetaoficial.gob.pa/pdfTemp/29048_B/GacetaNo_29048b_20200616.pdf
- _ WWAP (United Nations World Water Assessment Programme), UN-Water. (2018). *The United Nations World Water Development Report 2018: Nature-Based Solutions for Water*. Paris, UNESCO. Available at: www.unwater.org/publications/world-water-development-report-2018/

Part 4 Case 2 (Leon, Nicaragua)

- _ Ulrich, A. (Ed.), Reuter, S. (Ed.), Gutterer, B. (Ed.), Sasse, L., Panzerbieter, T. and Reckerzügel, T. (2009). *Decentralised Wastewater Treatment Systems (DEWATS) and Sanitation in Developing Countries*. A Practical Guide. WEDC, Loughborough University, Leicestershire, Available at: <https://wedc-knowledge.lboro.ac.uk/details.html?id=10409>
- _ Webinar at the CREW+ Academy on 30.09.2021 (Block 2, Module 6) Slides available at: <https://academy.gefcrew.org/en/resources>, Video available at: <https://youtu.be/U-PYdb2GoEY> (min. 37:25 - 55:25)
- _ Video on the facebook site of the German Embassy in Nicaragua (2 minutes). www.facebook.com/AlemaniaEnNicaragua/videos/846879636161809/
- _ IANAS-UNESCO (2020). *Water Quality in the Americas. Risks and Opportunities*. The Inter-American Network of Academies of Sciences, Mexico (p. 473, Box1) Available at: <https://ianas.org/wp-content/uploads/2020/07/02-Water-quality-INGLES.pdf>

Part 4 Case 3 (Nindiri, Nicaragua)

- _ La Gaceta Diario Oficial, Decree 21-2017 of Wastewater Discharge (Disposiciones para el Vertido de Aguas Residuales). Available at: www.inaa.gob.ni/sites/default/files/inline-files/Decreto%2021-2017.pdf
- _ Norma Técnica Obligatoria Nicaragüense (NTON), Nicaraguan Technical Standard for Wastewater Treatment and Reuse (2005). Available at: <http://legislacion.asamblea.gob.ni/normaweb.nsf/b34f77cd9d23625e06257265005d21fa/3b3583b8c7d4ee32062579bc007b7023?OpenDocument>

Part 4 Case 4 (Punta Cana, Dominican Republic)

- _ Daud MK, Rizvi H, Akram MF, Ali S, Rizwan M, Nafees M, Zhu SJ (2018). *Review of Upflow Anaerobic Sludge Blanket Reactor Technology: Effect of Different Parameters and Developments for Domestic Wastewater Treatment*. Journal of Chemistry, vol. 2018, Article ID 1596319. 13 pages. Available at doi: 10.1155/2018/1596319
- _ Grupo PROAMSA, Wastewater Treatment Specialists, Official Website: <https://grupoproamsa.com/> (last accessed February 2022)

Part 4 Case 5 (Lake Atitlan, Guatemala)

- _ CBSA (2020). *Policy brief: supporting the shift to climate positive sanitation*. Available at: <https://cbsa.global/resources>
- _ Mijthab, M., Anisie, R. & Crespo, O. Mosan (2021). *Combining Circularity and Participatory Design to Address Sanitation in Low-Income Communities*. *Circ.Econ.Sust.* 1, 1165–1191 (2021). Available at doi: 10.1007/s43615-021-00118-w
- _ Russel, K., Montgomery, I. (2020). *Container-Based Sanitation Implementation Guide 1st Edition*. Container-Based Sanitation Alliance, UK, London. Available at: <https://cbsa.global/resources>
- _ Russel, K.C., Hughes, K., Roach, M., Auerbach, D., Foote, A., Kramer, S., Briceño, R., (2019). *Taking container-based sanitation to scale: opportunities and challenges*. *Front Environ Sci* 7. Available at doi: 10.3389/fenvs.2019.00190
- _ Schmidt, H.P., Pandit, B.H., Cornelissen, G., Kammann, C., (2017). *Biochar-Based Fertilization with Liquid Nutrient Enrichment: 21 Field Trials Covering 13 Crop Species in Nepal*. *Land Degradation & Development*, 28(8), 2324-2342. Available at doi: 10.1002/ldr.2761
- _ Sklar, R., Faustin, C., (2017). *Pit Latrines or Container Based Toilets? Haiti Priorise*. Copenhagen Consensus Center. Denmark. Available at: www.copenhagenconsensus.com

Part 4 Case 6 (Tolata, Bolivia)

- _ Aguatuya Foundation Official Website: <https://aguatuya.org/> (last accessed February 2022)
- _ Echeverria, I., Machicado, L., Saavedra, O., Escalera, R., Heredia, G., Montoya, R. (2019). *Domestic wastewater treated by anaerobic baffled reactors and gravel filters as a resource to be used in agriculture*. *INVESTIGACION & DESARROLLO*. 19. 63-72 Available at doi: 10.23881/idupbo.019.1-4i
- _ Barber, W.P., and Stuckey, D.C., (1998). *The Influence of Start-Up Strategies on the Performance of an Anaerobic Baffled Reactor*. *Environmental Technology*, 19:5, 489-501. London.UK. Available at doi: 10.1080/09593331908616705
- _ Heredia, G., Becerra, A., Saavedra, O., Echeverria, I. (2020). *Evaluación del costo anual equivalente de las plantas de tratamiento de aguas residuales de los municipios de Cliza y Tolata*. *INVESTIGACION & DESARROLLO*. 19. 75-82. Available at doi: 10.23881/idupbo.019.2-5e.
- _ Kenton, W. and Kindness, D. (2020). *Equivalent Annual Cost – EAC Definition*. Investopedia Online Article. Dotdash Meredith Publishing. Available at: www.investopedia.com/terms/e/eac.asp (last accessed February 2022)
- _ Heredia, G., Gandarilla, V., Becerra, A., Valenzuela, L. (Ed.), (2020). *Tratamiento descentralizado de aguas residuales con enfoque de reúso en Cochabamba*, Bolivia, SuSanA Latinoamérica Available at: www.susana.org/_resources/documents/default/3-3983-7-1607703202.pdf

Photo Credit:

Reproduced with the authors permission or under creative commons license as indicated:

Page 39: © SuSanA_giz flickr licensed under CC-BY SA 4.0/Hoffmann, <https://flic.kr/p/7VSCXw>; Löw, <https://flic.kr/p/9X-zGm8>, © mosan, © Demant, ©Kraemer, © Horvath, licensed under CC BY-SA 2.0, <https://flic.kr/p/2hzH19H>; Page 49: © BORDA Las Américas, © Kraemer, © Demant, © SuSanA_giz flickr licensed under CC-BY SA 4.0, <https://flic.kr/p/8CTUT1>; Page 63: © Demant, © mosan, © BORDA Las Americas, © SuSanA_giz flickr licensed under CC-BY SA 4.0, <https://flic.kr/p/5vUaqB>; Page 75: © mosan, © BORDA Las Américas, © Zweckverband Linz-Unkel, © PROAMSA S.A.; Page 119: © BORDA Las Américas, © Rich Earth Institute, © mosan, © Kraemer, © Reuter; Page 148-150: © WeCo SAS; Page 152: ©Envirosan; Page 153: ©Enviro Options; Page 154: ©LiquidGold; Page 155: © SCG Chemicals; Page 202, 205: © Green Engineering Corp.; Page 206, 208, 211: © BORDA Las Américas; Page 212, 215: © BIOSAM S.A.; Page 216, 219: © PROAMSA S.A.; Page 220, 222, 223, 225: © mosan; Page 226, 231: © Aguatuya;

Imprint

Published By:

Bremen Overseas Research and Development Association e.V. (BORDA)
Am Deich 45,
28199 Bremen
Germany

Eawag

Department of Sanitation, Water and Solid Waste for Development (Sandec)
Überlandstrasse 133
P.O. Box 611, 8600 Dübendorf
Switzerland

Graphic Design & Technical Drawings:

Pia Thür, Paolo Monaco, Mona Trockel, Jette Noa, Annika C. Nordin

Text Editing:

Paul Donahue

Quote as:

Reuter, S., Demant, D., Heredia, G., Lüthi, C., Reymond, P., Schertenleib, R., Ulrich, L., Zurbrügg, C. (2022).
Compendium of Sanitation Systems and Technologies for the Wider Caribbean Region.
Bremen Overseas Research and Development Association (BORDA). Bremen, Germany.

Stefan Reuter: *aqua & waste GmbH, Hannover, Germany*

Dierk Demant: *OSE Corporation V.B.A, Aruba*

Gustavo Heredia: *Consultant, Cochabamba, Bolivia*

Lukas Ulrich: *VUNA GmbH, Dübendorf, Switzerland*

all other authors: *eawag, Dübendorf, Switzerland*

April 2022

Disclaimer:

This publication contains links to external websites. Responsibility for the content of the listed external sites always lies with their respective publishers. When the links to these sites were first posted, BORDA & Eawag checked the third-party content to establish whether it could give rise to civil or criminal liability. However, the constant review of the links to external sites cannot reasonably be expected without concrete indication of a violation of rights. If BORDA & Eawag themselves become aware or are notified by a third party that an external site it has provided a link to gives rise to civil or criminal liability, they will remove the link to this site immediately. BORDA & Eawag expressly dissociate themselves from such content.



This publication is licensed under Creative Commons:
Attribution – NonCommercial – NoDerivatives 4.0 International



BORDA Las Americas
Dr. Atl 274
Colonia Santa María La Ribera
Delegación Cuauhtémoc
CDMX CP-06400,
Mexico
Phone +52 1 5541 8158
mex@borda-la.org
www.borda-la.org
www.borda.org

Eawag
Department Sandec
Überlandstrasse 133
P.O. Box 611
8600 Dübendorf
Switzerland
Phone +41 (0)44 823 52 86
info@sandec.ch
www.eawag.ch
www.sandec.ch



This is the first Compendium for the Wider Caribbean Region!

Largely based on the Eawag Compendium of Sanitation Systems and Technologies, it was adapted to the needs of the region through prior research, active stakeholder involvement and contextualisation of the technical and social aspects.

The Compendium is a guidance document for engineers and planners in the Wider Caribbean Region and beyond. By ordering and structuring tried and tested technologies into one concise document, the reader is provided with a useful planning tool for making more informed decisions. The focus of this Compendium is on the range of urban and peri-urban technologies that can be provided and managed as a utility service.

- Part 1** describes different system configurations for a variety of contexts.
- Part 2** consists of 48 different technology information sheets, which describe the main advantages, disadvantages, applications and the appropriateness of the technologies required to build a comprehensive sanitation system. Each technology information sheet is complemented by a descriptive illustration.
- Part 3** covers cross-cutting issues for planning and decision making relevant for implementing the Regional Strategic Action Plan (RSAP) in the sanitation sector for the Wider Caribbean Region.
- Part 4** presents selected case studies showcasing systems and technologies under real life conditions including institutional, regulatory, and financial aspects as well as lessons learned.